

USING A VIRTUAL ENVIRONMENT TO EVALUATE PEDESTRIAN STREET
CROSSING DECISIONS AT A TRAFFIC ROUNDABOUT

By

Haojie Wu

Dissertation

Submitted to the Faculty of the
Graduate School of Vanderbilt University
in partial fulfillment of the requirements
for the degree of

DOCTOR OF PHILOSOPHY

in

COMPUTER SCIENCE

August 31, 2019

Nashville, Tennessee

Approved:

Professor Bobby Bodenheimer

Professor Daniel Ashmead

Professor Julie Adams

Professor Benoit Dawant

Professor D. Mitchell Wilkes

ACKNOWLEDGMENTS

The path toward this dissertation has been circuitous. It could not have been completed without the support of many special people. Chiefly among those is my adviser, Dr. Bobby Bondenhermer. I am grateful for his personal and professional guidance through all these years. His influence on my research provided the foundation of my career. His help carried me through hard times. Thank you for being patient with me, Bobby.

I sincerely thank Dr. Daniel Ashmead, who not only provided financial support to this research, but also offered extremely valuable advice. I can always count on his prompt response to my questions.

It has been a pleasure to have Dr. Julie Adams, Dr. Benoit Dawant, and Dr. Mitchell Wilkes on my committee. I appreciated their insightful comments and suggestions that help me to improve this dissertation.

The most important faith and encouragement came from my family. I thank my incredibly supportive parents. Without their sacrifices completing a doctorate would not be possible. Last but not least, I thank my wonderful sons, YoYo and QuanQuan, who continue to inspire me and remind me to pursue my dreams.

TABLE OF CONTENTS

	Page
ACKNOWLEDGMENTS	ii
LIST OF TABLES	vi
LIST OF FIGURES	vii
I Introduction	1
II APGV paper: Using Immersive Virtual Reality to Evaluate Pedestrian Street Crossing Decisions at a Roundabout	6
Preface	6
Introduction	8
Related Work	9
System Design	10
Model of the Environment	10
Traffic Simulation	12
Street Crossing	14
Experiment	15
Maximum-likelihood Method	15
Participants	17
Materials and Apparatus	17
Procedure	18
Results	20
Discussion	22
III SIVE paper: 3D Sound Rendering in a Virtual Environment to Evaluate Pedestrian Street Crossing Decisions at a Roundabout	24
Preface	24
Introduction	26
Related Work	28
System Design	30
Virtual Environment	30
Traffic Simulation	30
Audio Simulation	31
Experiment and Results	33
Experiment 1	34

	<i>Procedure</i>	34
	<i>Results</i>	36
	Experiment 2	37
	<i>Procedure</i>	37
	<i>Results</i>	37
	Discussion	38
IV	ACM paper: Using Virtual Reality to Evaluate Pedestrian Street Crossing at a Roundabout	40
	Preface	40
	Introduction	41
	Background	43
	Roundabout Virtual Environment and Traffic Simulation	45
	System Basis	45
	Circulating Traffic	46
	Traffic Trial Update	48
	Experiment and Results	49
	Design and Protocol	49
	Hypothesis	51
	Apparatus and Participants	51
	Results and Analysis	52
	Discussion	55
V	Frontiers paper: Using Virtual Reality to Assess the Street Crossing Behavior of Pedestrians with Simulated Macular Degeneration at a Roundabout	58
	Preface	58
	Introduction	59
	Background and Related Work	62
	The Roundabout Virtual Environment	64
	Simulating Macular Degeneration	66
	Optical Distortions	66
	Gaze-contingent	67
	Experiment and Results	68
	General Design	68
	Hypotheses	71
	Participants	72
	Apparatus	72
	Procedure	73
	Results	74
	Discussion	79
VI	Conclusion	82

BIBLIOGRAPHY	86
Appendices	96
A Questionnaire for Experiments in Chapter III	97

LIST OF TABLES

Table	Page
III.1 Mean gap crossing time for Experiment 1 in seconds.	36
IV.1 Key measures in seconds	53
V.1 Key measures in seconds under different scotoma conditions.	76

LIST OF FIGURES

Figure	Page
II.1 Model of the Pullen-Stinson roundabout. Scale: $a = 52 \text{ ft}$; $b=18\text{ft}$; $c=14\text{ft}$; $d=12\text{ft}$. One crossing location: $A \Leftrightarrow B$.Three critical traffic entry paths of concern in our study: $G \Rightarrow H \Rightarrow K \Rightarrow N \Rightarrow C$; $J \Rightarrow K \Rightarrow N \Rightarrow C$; $M \Rightarrow N \Rightarrow C$. . .	11
II.2 A rendering of the virtual environment showing the crosswalk from a pedestrian’s point of view facing north (A facing B in Figure II.1).	14
II.3 A rendering of the virtual environment from a pedestrian’s viewpoint facing the roundabout as if trying to make a crossing decision.	14
II.4 Function fitting with the collected data. Blue dots show the relation between the target gap and the proportion of participants successful crossing. The red curve is a fitting curve with the Logistic Function.	16
II.5 An example of result. The top chart shows the trials for the north facing direction and the bottom chart shows trials for the south facing direction. Blue circles indicate that the participant crossed and red circles indicate that the participant did not cross at the target gap.	20
II.6 The distribution of street crossings for all participants in both directions. Successful crossings accounted for 60% of the total number of crossings. .	21
III.1 An overview of our virtual environment, modeled on the Pullen-Stinson roundabout, showing traffic circulating. Pedestrians cross at the walkways. .	31
III.2 View of car approaching the traffic crossing from the eye-height of one of the authors, and shows the several of the car models used in the simulation.	31
III.3 The Simulink implementation of the HRTF filter.	32
III.4 Blurred displays experienced by participants in Experiment 1 (left) and Experiment 2 (right). In both scenes the view is from the side of the road with a car approaching. Notice that while the lead car can be seen, as in Figure III.2, details of further cars are obscured in both cases.	34
III.5 Results for one of the participants.	39

IV.1	Model of the Pullen-Stinson roundabout	45
IV.2	The simulation system including graphics and audio generation	46
IV.3	Exiting traffic paths	47
IV.4	Circulating traffic paths	47
IV.5	An example of an updated traffic scenario. Blue rectangles represent vehicles moving from left to right. Vehicles 1, 3, 5 will exit and vehicles 2, 4 will circulate. A target gap is randomly set between the 2nd and the 3rd car for 5 seconds.	49
IV.6	Gap threshold variance by circulating traffic conditions	51
IV.7	The distribution of street crossing by group	55
V.1	An overview of a roundabout virtual environment.	65
V.2	Traffic view within the roundabout.	65
V.3	Macular Degeneration simulation (a black area, 10° of visual angle, surround by a blurred area, 20° of visual angle).	65
V.4	Visual acuity tested by a Snellen chart (X axis represents the scale of the blur. Scale 1 makes the scene opaque and scale 0 makes the scene clear. Y axis represents Snellen fraction.)	67
V.5	The architectural model of the roundabout, showing the pedestrians crossing area and vehicle travel paths.	69
V.6	Crossing distribution by group and crossing distribution by gender in experiment.	75
V.7	Medians and quartiles of the various measures broken out by vision condition and gender.	78

CHAPTER I

Introduction

Immersive Virtual Environments (IVEs) provide the ability to simulate a believable and realistic world under conditions that can be controlled. This ability is advantageous in many domains where studying human behavior under rigorous real-world conditions may be difficult, expensive, or dangerous. For example, pilots are trained in virtual simulations to respond to conditions that are rare but critical, and a failure to respond correctly would lead to severe consequences including potentially a large loss of life (Lee, 2006). In such simulations, visual, auditory and haptic cues can provide the aviator a safe and economical training environment. Likewise, virtual driving simulations create scenarios that cannot be easily duplicated or safely experienced in the real-world; for example, hazardous conditions in rough terrain and low visibility due to inclement weather (Kemeny and Panerai, 2003). This dissertation deals with simulations for a different scenario, that of pedestrian behavior at traffic crossings. Like the previous scenarios, though, pedestrian-traffic behavior is well suited to study in an IVE, since traffic intersections can be dangerous, are expensive, and are difficult to simulate in the real world.

Crossing streets is a potentially hazardous activity for pedestrians, especially for vulnerable population such as elderly, children, or visually impaired individuals. It is made more hazardous when the complexity of the intersection increases beyond a simple linear intersection, as in the case of a roundabout. The safety concern makes us interested in pedestrians' crossing decisions at this type of intersection. In particular, we would like to examine how well people can judge time gaps in vehicle traffic that would enable them to cross. We focused on the gaps of an interval in the traffic that are caused by separations in vehicle arrivals, not the gaps due to vehicles yielding for pedestrians. An IVE of such an intersections allows people to physically walk across a virtual street with virtual traffic,

which presents a safe and controllable way to study the gap crossing decisions.

Roundabouts are more and more seen in the United States as desirable intersection designs due to improved safety and efficiency features over traditional intersections (Board et al., 2007). Vanderbilt University, located in Nashville, is increasingly turning to roundabouts to ease traffic congestion (Arradondo and Kirkpatrick, 2019; Layden, 2019). Modern roundabouts are traffic junctions where traffic enters a circulating one-way stream of traffic around a central island. Pedestrian crosswalks only occur at the entry/exit lanes, and are usually not controlled by traffic signals. Although roundabouts are generally considered safe for drivers, pedestrian behavior at these intersections has been understudied. From a pedestrian's viewpoint, crossing at a roundabout can represent a more complex decision than at a normal linear intersection, because traffic is likely to be more confusing with a circulating pathway, where vehicles can be entering from and exiting in several directions. More concerns about pedestrians safety are raised at an exit lane of a roundabout, because previous research has indicated that drivers usually do not yield when they exit roundabouts (Inman et al., 2006).

This dissertation presents the development of a roundabout virtual environment where pedestrian's gap crossing behavior in traffic can be thoroughly studied. The environment was modeled after the Pullen-Stinson roundabout at North Carolina State University, a typical American compact urban roundabout. It is a single lane roundabout accompanied with crosswalks and splitter islands placed near entry/exit lanes. In addition to a static virtual scene, the IVE consists of three dynamic simulations: a traffic simulation, a spatialized acoustic simulation, and a simulation for visual deficits of a user.

The traffic simulation is designed to generate traffic streams that not only comply with real world traffic regulations, but also provide gaps between moving vehicles on demand. In the traffic simulation, a vehicle should reduce speed upon approaching the roundabout and accelerate back to its original speed upon exiting. Additionally, a vehicle must seek to avoid collisions with other vehicles and pedestrians. Vehicles can be scheduled in a traffic stream

so that their driving paths and the time gaps between them are controlled. The controllable traffic stream allows us to conduct rigorous studies on pedestrian behavior in a roundabout.

Pedestrian behavior at traffic intersections has, of course, been studied before, even in IVEs (Plumert et al., 2004, 2007). However, prior work has focused on linear intersections, has downplayed the role of audio cues, and has not considered visual deficits. Crossing behavior at the exit lane of a roundabout is interesting, because exiting drivers rarely yield to pedestrians (Inman et al., 2006), but also because the situation presents potential uncertainty to the pedestrian given that a vehicle may travel down the exit lane or continue along the rotary circle. Thus, to a pedestrian waiting at an exit lane, a vehicle that will continue circulating in the circle might offer more opportunity to cross the street. Our simulation offers the ability to combine exiting and circulating driving paths in a traffic stream and test constructed streams against pedestrians' crossing decisions.

We expect that decisions about when to cross the street are made primarily on the basis of visual cues. However, in the real world auditory cues are also available and may provide salient information, particularly to people with visual deficits. Our IVE incorporates an acoustic simulation that provides 3D spatialized traffic sounds to give such auditory cues. In particular, our acoustic simulation synthesizes binaural audio for moving vehicles in the IVE so that pedestrians have rich auditory cues to support their crossing decisions. This enables us to explore how 3D spatialized sound affect pedestrians' gap crossing behavior.

The binaural audio reproduction applies spatial domain convolution of sound waves using an approximate head-related transfer functions (HRTFs). An HRTF characterizes how an ear receives a sound from a point in space. It is specific to each individual as the size and shape of the head and ears are distinct for each individual. Since measuring individual HRTFs is laborious and expensive, we employ non-individual HRTF. Our audio simulation utilizes the non-individual HRTF published by the MIT Media Lab (Gardner and Martin, 1995).

Since visual cues are the primary cues for pedestrian crossing behavior, visual deficits

present a challenge for pedestrians who have them, and, consequently, a public safety concern (Ashmead et al., 2005; Guth et al., 2005). For example, macular degeneration, a central vision field loss disease, impacts millions of people and eventually leads to blindness (Wong et al., 2014). Studying such patients in an IVE is problematic, however, because recruiting them is difficult and there are safety concerns with such persons, often elderly, wearing a head-mounted display (HMD). Our solution is to build a simulation of such visual deficits and expose normally sighted individual to them. We then study how such individuals perform gap crossing behaviors when presented with a visual deficit. In one sense, this may present a bound on behavior for the real world. Our focus was on simulating macular degeneration, although other visual deficits could be easily accommodated.

To recapitulate, the contribution of this dissertation is that we develop an IVE of a complex real-world traffic scenario and build a controllable traffic simulation around it that allows us to test pedestrian crossing behavior in it. Our IVE has spatialized sound that allows audio cues and supports simulation of visual deficits to model the appearance of traffic crossing by the visually impaired. This type of IVE is novel. We assess our IVE to determine the affect how participants behave in a roundabout, assess how traffic patterns (circulating versus non-circulating traffic) affect judgment, and compare to published real-world literature on gap selection at roundabouts. We assess how well spatialized sound contributes to gap crossing judgments in this type of environment. Also, we examine the role of visual deficits in gap crossing behavior and look at the severity of visual deficit as compared with the gap judgment. To our knowledge, we present the only controlled study of gap crossing behavior at a roundabout, and the only study of the salience of spatialized sound and visual deficits on gap crossing behaviors.

This dissertation is organized as follows, and is based on our publications (two conference and two journal, one under review). The chapters are presented in chronological order of the publications, with each chapter containing an extended summary of the paper followed by the texts of the papers. Chapter II describes the development of the IVE and initial

evaluation of pedestrian gap judgments using it (Wu et al., 2009). Chapter III describes the development and implementation of the spatialized sound system, as well as our evaluation of it on gap crossing judgments (Wu et al., 2018a). Chapter IV contains our extension of the roundabout traffic simulation to accommodate circulating traffic, and our evaluation of it (Wu et al., 2019). Chapter V describes the implementation of our system for simulating visual deficits using an eye-tracked HMD, and our evaluation of this system (Wu et al., 2018b). Chapter VI summarizes the contributions of the dissertation *in toto* and presents directions for future research.

CHAPTER II

APGV paper: Using Immersive Virtual Reality to Evaluate Pedestrian Street Crossing Decisions at a Roundabout

Preface

Our initial work was to build a baseline system that evaluates pedestrian street crossing decisions at a roundabout virtual environment. In particular, we leveraged the locomotive capabilities of the immersive virtual environment to assess the gap duration between moving vehicles that people need to cross the exit lane of a roundabout.

We first created a roundabout model out of a real-world roundabout, the Pullen-Stinson roundabout located on the North Carolina State University campus. The virtual environment has identical scale and similar architecture. The movement interface for this IVE was real walking. Since the roundabout is considerably large than the physical lab space housing our IVE equipment, only a portion of the IVE (such as the crosswalk of the exit lane) was accessible at a given time.

For this IVE, we developed a traffic simulation that follows the traffic regulations for a roundabout intersection. Traffic approaches from several entry points and can exit to one of several directions. On approach to the roundabout, a vehicle gradually reduces speed and maintains relatively low speed while on the circulatory roadway of the roundabout. Upon exiting the roundabout, it gradually accelerates back to the original approach speed. Vehicles entering the roundabout yield to vehicles already on the circulatory roadway. In general, vehicles will maintain spacing to avoid collisions. We included different models of the car in the system. Individual cars can be scheduled to start at any time in any initial velocity along any of the travel paths of the roundabout to generate a variety of traffic scenarios.

Users in the IVE become pedestrians, and can walk to cross the street among the traffic. Vehicles will yield to pedestrians in front of them. The task for pedestrians is to find

safe and comfortable gaps to cross the street upon traffic streams in this immersive virtual environment. For typical controlled experiments, in each stream of traffic, the gaps between most cars will be set short enough to disallow pedestrian crossing, and there will be only one longer gap, called the target gap, where there is a possibility for a pedestrian to make a “go–no-go” decision to cross.

In order to evaluate the minimum gap a participant might choose to cross, we asked each participant to cross the street many times in dynamically generated traffic streams. If the pedestrian started crossing during the target gap, the outcome was deemed a “go”. If the target gap went by without the pedestrian having started to cross, the outcome would be a “no-go”. A go result could be either a “safe” crossing when the pedestrian finished crossing before the target gap ended, or an “unsafe” crossing otherwise. We used a maximum-likelihood procedure to determine the length of the target gap of each traffic stream. This procedure eventually converges to the gap threshold value, i.e., the minimum value that a pedestrian would accept to initiate a crossing.

In our first experiment, twelve participants, six males and six females participated. The results were generally consistent with real-world data on pedestrian street crossings. For all participants, the average minimal gap at which they would cross the intersection 75% of the time was 4.08 seconds [SE=0.11], without significant difference in crossing direction. For those go and safe crossings, the average minimal gap is 4.37 seconds [SE=0.29]. The data also showed that participants’ average crossing time for successful crossings was less than the target gaps, which means people did select gaps greater than the length of time it takes to cross.

The results of this chapter demonstrate a viable testbed for exploring pedestrian crossing behavior in a roundabout environment. That is, this system provides a reliable design that simulates reasonable traffic patterns that a pedestrian might encounter in making a crossing decision at the exit lane of a roundabout. This work was presented at the ACM Symposium on Applied Perception in Graphics and Visualization (APGV) 2009 in Chania, Crete, Greece

(Wu et al., 2009).

Introduction

One of the important applications of virtual environments is the study of situations that are difficult or expensive to study in the real world. Immersive virtual environments allowing a locomotive interface may preserve the perception-action coupling that is critical in examining many visual timing skills (Gibson, 1979). In this paper we use virtual environments to study pedestrian behavior in street crossing situations, in particular when crossing the street at a roundabout.

Modern roundabouts are traffic junctions where traffic enters a circulating one-way stream of traffic around a central island. Pedestrian crosswalks occur at the entry and exit lanes, i.e., they do not occur in the circulating path. For countries like the United States where vehicles travel on the right-hand side of the road, the circulation is anti-clockwise. Roundabouts are usually not controlled by traffic signals. In the United States, Europe, and Australia, studies have shown that roundabouts are safer than traffic-light controlled intersections for vehicular crashes and injuries, and, in the United States, delays in roundabouts are less than under previous traffic control methods (Jacquemart, 1998). This increase in safety is the result of lower speed entering and circulating, the reduction of potential conflict points, such as head-on and right-angle crashes, and travel at similar speeds by most vehicles through the roundabout (Nambisan and Parini, 2007). The effect of roundabouts on safety of bicyclists and pedestrians is less well established.

In this paper, we use virtual environments to study pedestrian crossing behavior at exit lanes of roundabouts, because previous research indicated that drivers usually do not yield when they exit roundabouts (Inman et al., 2006). And drivers behavior raises concerns about pedestrian safety at such intersections, since there is usually no traffic control, as mentioned previously. In particular, we are interested in studying how well people can judge gaps in vehicle traffic that would enable them to cross. A gap is an interval in the traffic where

pedestrians believe they may safely cross, and can be caused either because no vehicles arrive at the crossing location for the length of time necessary for the crossing to occur, or because vehicles yield or stop for pedestrians. In this paper, we do not study the latter behavior, as it requires a validated model of vehicle behavior that is beyond our current scope of study. Thus, we only study gaps that are caused by separations in vehicle arrivals. This issue is likely to be more confusing in a roundabout, where vehicles can be entering the circulating pathway from several directions.

Related Work

Several perceptual factors influence street crossing decisions, both auditory and visual. Among the visual cues are perceived distance of approaching vehicles and their arrival times. Distance perception in virtual environments has been studied extensively, e.g., (Thompson et al., 2004), and is known to be problematic, but is not studied in this paper. Arrival time, or time-to-contact, has also been studied extensively, and in the context of traffic, our group conducted an evaluation of the time-to-contact judgments of participants in road-side environments using realistic models of vehicles (Seward et al., 2007). This work found time-to-contact judgments in a virtual environment using a head-mounted display consistent with prior findings from real traffic settings, e.g., (Guth et al., 2005), and that the type of vehicle model was not significant in participants ability to discriminate time-to-contact. It also showed that when contact was estimated from a bypass viewpoint, as occurs on the side of the road, the discrimination did not significantly differ from the traditional head-on view of most time-to-contact studies. This result was consistent with prior work (Schiff and Oldak, 1990), but extended the bypass angle for which this result was known to be valid, providing generalization to the geometry of real road crossings.

Gap selections in traffic have been studied at both linear traffic junctions and roundabouts. Ashmead et al. (2005) and Guth et al. (2005) studied pedestrian crossing behavior at roundabouts in the real world with both normally sighted and visually impaired pedestrians,

finding that pedestrians chose a gap of 6 seconds or more to cross. Simpson et al. (2003) did a gap crossing study with children and adults in a virtual environment. They used a linear intersection with a uniform vehicle size presented non-stereoscopically. While their crossing times are difficult to make equivalent to our times, reported in the following, in their experiments participants made safe crossings with average gaps of about 8.4 seconds. In both studies the selected gap times corresponded to the time needed for a pedestrian to walk across the road.

Road-crossing behavior, and particularly gap judgments, have been of particular interest for children, since children are an at-risk segment of the population to traffic injuries. Research has shown that younger children make poorer choices (Connelly et al., 1998), but that both children and adults use a combination of distance and speed to make the gap judgments (te Velde et al., 2005). Plumert and colleagues (Plumert et al., 2004, 2007) have used large-screen immersive virtual environments to examine bicycling crossing behavior and gap crossing choices in children and adults. In contrast, our work uses a stereoscopic head-mounted display allowing locomotion through significant parts of the environment.

System Design

In this section we describe the virtual environment, the traffic simulation and control laws, and street crossing scenarios.

Model of the Environment

There are only a few hundred roundabouts in the United States (Nambisan and Parini, 2007). Our roundabout environment is modeled on the Pullen-Stinson roundabout located on the North Carolina State University campus. As shown in Figure II.1, this roundabout has a single lane plan. The circular central island diameter (referred as “a ” in the Figure) is 52 ft. The width of the circulatory roadway (referred to as “b ”) is 18 ft. The entry width (“c ”) is 14 ft. There are splitter islands at each approach that separate the entry and exit lanes at each street. Crosswalks are cut through the splitter island at the street level. The part of a

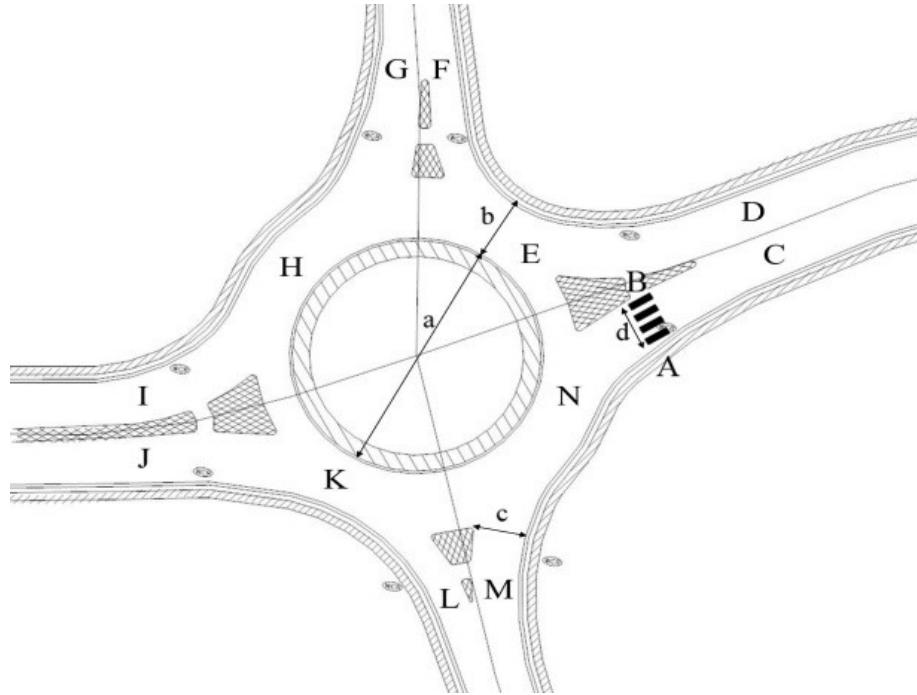

Figure II.1: Model of the Pullen-Stinson roundabout. Scale: $a = 52$ ft; $b=18$ ft; $c=14$ ft; $d=12$ ft. One crossing location: $A \Leftrightarrow B$. Three critical traffic entry paths of concern in our study: $G \Rightarrow H \Rightarrow K \Rightarrow N \Rightarrow C$; $J \Rightarrow K \Rightarrow N \Rightarrow C$; $M \Rightarrow N \Rightarrow C$.

crosswalk used for pedestrian crossings in our experiment is the shaded area between points A and B, which is 10 ft. wide and 12 ft. long (“d”).

For pedestrian traffic crossing between A and B, vehicles travel along three critical paths in the roundabout. One is the left-turn path, i.e., a vehicle moving from through points $G \Rightarrow H \Rightarrow K \Rightarrow N \Rightarrow C$. Another is the straight-through path, i.e., $J \Rightarrow K \Rightarrow N \Rightarrow C$. The final one is the right-turn path, i.e., $M \Rightarrow N \Rightarrow C$. Pedestrians must assess traffic from these three paths to determine if it is safe to make a crossing. In our simulations, we simplify the traffic pattern slightly and do not let vehicles orbit, so that vehicles only come from the three different entry legs (G, J, and M), and all leave through the same exit leg (referred as C).

The Pullen-Stinson roundabout is an accessible pedestrian environment. It has well-defined walkway edges. Crossing locations are easy to identify. Ramps are provided on each end of the crosswalk to connect to the sidewalk network. Prior work has observed

pedestrian crossing behavior in this roundabout (Rouphail et al., 2005). This paper employs an immersive virtual environment with similar architecture and scale to provide more controlled simulations than are capable in the physical environment. The model of the roundabout was built in Maya (Autodesk, San Rafael, CA) and exported to Vizard (Worldviz, Santa Barbara, CA).

Traffic Simulation

The traffic simulation system was implemented in Vizard. Both a vehicles path and speed are controlled. In the Pullen-Stinson environment, prior observation (Rouphail et al., 2005) showed that the average approach speed of vehicles was 35 mph, the circulating speed was 18 mph, and the peak hourly volume is 1400 vehicles and 160 pedestrians. We simulate a relatively low traffic volume in our system: the approach speed is 25 mph, circulating speed is 13 mph, and the average number of vehicles per hour is 1100. Thus, on approach to the roundabout, a vehicle gradually reduces speed from the approach speed to the circulating speed, and maintains the circulating speed while on the circular part of the roundabout. Upon exiting the roundabout, it gradually accelerates back to the original approach speed.

Complicating this behavior are provisions for vehicle-vehicle interaction and vehicle-pedestrian interactions. To avoid collisions, vehicles decelerate so that they are no closer than a predetermined forward sight distance to the foregoing vehicle, and accelerate once no vehicle is detected in the forward sight distance. Vehicles entering the roundabout yield to vehicles already on the circulatory roadway, and accelerate to enter the circulating path once no vehicle remains in a predetermined intersection sight distance. When pedestrians are inside the crosswalk area and they are in the predetermined forward sight distance of a vehicle, the vehicle yields to them. All such behaviors are implemented using the same predefined distance method. Traffic interactions are not so complex that conflicting objectives needing resolution arise in the system as it currently exists, and within the broad parameters described above the visual appearance of the traffic simulation was tuned until it

appeared reasonable as evaluated in several pilot studies.

There is a single control system that controls all vehicles. This system is currently not agent-based; thus, a single scheduler controls all the start times and all traffic paths for the vehicles, and can start them at any initial velocity along any of the travel paths of the roundabout. This system can, therefore, generate a variety of traffic scenarios providing a series of predictable gaps during which pedestrians can cross. Of course, the traffic simulation is stable, even taking into account changes in speed as cars enter and exit the roundabout as well as vehicle-vehicle interaction. Without vehicle-pedestrian interactions, the same traffic schedule generates almost the same gap serials. The error in gap size is less than 0.01 second. We believe the error is due to the non real-time latency of the operating system, but did not pursue the exact cause.

For experimental purposes, we typically program the system so that traffic comes in a stream of vehicles. The number of vehicles in a stream is random (between 4 and 10), and the models of the cars are randomly selected from among the 10 available candidate models.

The entry paths for the vehicles are also chosen randomly. The gap between any two vehicles, measured by the amount of time between the front bumper of one vehicle passing a point and the front bumper of the next vehicle passing the point, is controlled for each stream. Typically, the gap between most cars will be short, less than 2 seconds, but there will be one longer gap, in the range from 2 to 12 seconds. The location of this gap is randomly set by the system. The main objective of the paper was to measure the gap duration at which people would typically cross the street, and to verify that they were choosing a safe gap, that is, one that would allow the pedestrian to cross before the next vehicle arrived at the crosswalk.

Spatialized audio is supported in our system with respect to distance. For each moving vehicle, the same monaural sound is sent to both ears. The intensity of these sounds changes depending on distances between vehicles and the participant.

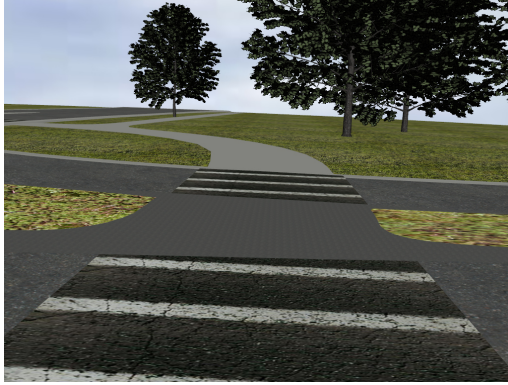

Figure II.2: A rendering of the virtual environment showing the crosswalk from a pedestrian's point of view facing north (A facing B in Figure II.1).



Figure II.3: A rendering of the virtual environment from a pedestrian's viewpoint facing the roundabout as if trying to make a crossing decision.

Street Crossing

We consider two directions of pedestrian travel. Referring to Figure II.1, pedestrians either start facing north and cross from point A to point B, or start facing south and cross from point B to point A. A rendering of the crosswalk is shown in Figure II.2. Pedestrians see a specific stream of cars coming from point G, J, and M, passing by, and exiting the roundabout at point C. An example rendering of the roundabout with traffic in it is shown in Figure II.3. A pedestrian must make judgments about the speed, travel paths of approaching vehicles, and the duration of gaps between vehicles, then decide to cross the street or not. In the process of street crossing, pedestrians can look towards the traffic to acquire more information about approaching traffic. As noted earlier, vehicles will yield to pedestrians on the crosswalk and let pedestrians finish crossing. Participants were instructed, however, not to deliberately force vehicles to yield. If one car yields for participants, the following cars decelerate as needed. Once pedestrians finish crossing and nobody is on the crosswalk, traffic will resume.

Experiment

We conducted an experiment to determine the minimum gap distance that participants could successfully select to cross one exit lane of the roundabout (between A and B in Figure II.1).

Participants were presented with a succession of traffic streams containing target gaps of different lengths, and were asked to cross the street when a gap in traffic occurred, such that they felt safe and comfortable crossing. Note that each stream in a trial contained a sequence of vehicles, most of which were separated by short gaps, but two of which were separated by a relatively long target gap through which a participant could cross or not. Thus, an outcome for a given stream of traffic in a trial was deemed a “success” or “go”, if the pedestrian started crossing during the target gap. A “failure” or “no-go” outcome occurred if the target gap went by without the pedestrian having started to cross. Under “success” or “go” conditions, a “safe” crossing indicated the participant finished the crossing behavior before the target gap ended. Otherwise, the outcome fell into the “unsafe” crossing category. An “invalid” outcome occurred if the pedestrian started crossing during a gap preceding the target gap, in which case that stream was invalidated and repeated in later trials.

Maximum-likelihood Method

To estimate the discrimination threshold with good accuracy and minimal trials, we adopted a maximum-likelihood stimulus procedure (Grassi and Soranzo, 2009). In this method, a maximum-likelihood procedure is used to calculate the next target gap by optimizing over candidate psychometric functions using the participants prior responses. Initialization is typically a problem with such methods, so we ran a single participant using a classic method of limits (Green and Swets, 1966) to get a candidate stimulus function. The participant was asked to cross the street 210 times. Target gaps were randomly distributed from 2 to 12s in 0.5s increments and 10 times for each target gap. We recorded all results of crossing task. Figure II.4 shows the participant’s data fitted with a logistic function of the form II.1:

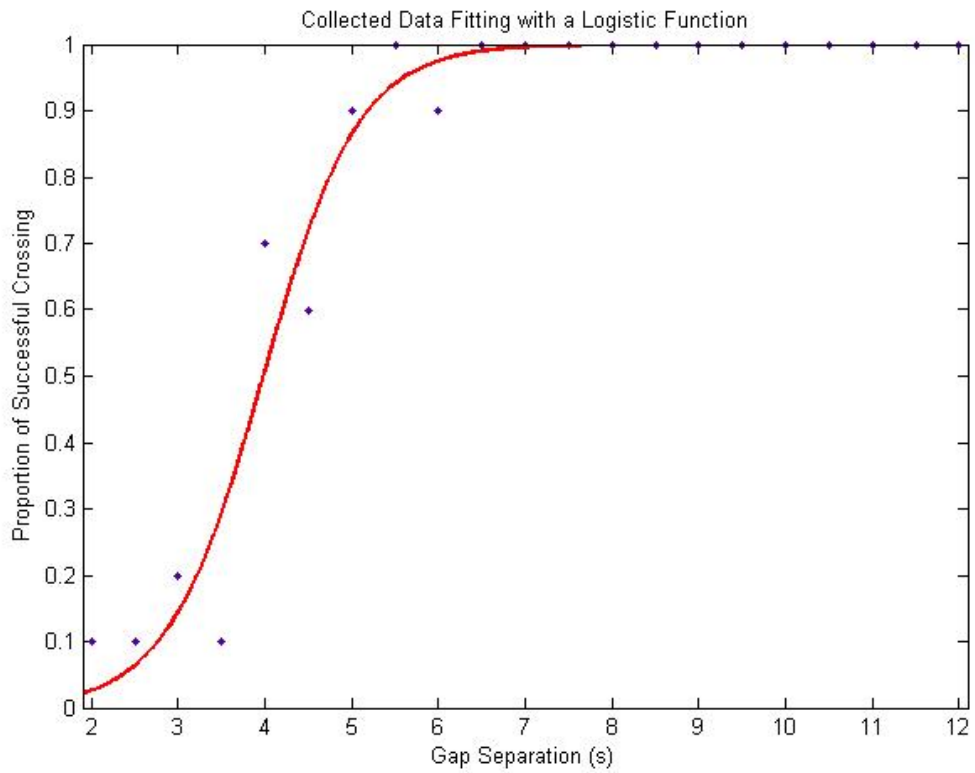

Figure II.4: Function fitting with the collected data. Blue dots show the relation between the target gap and the proportion of participants successful crossing. The red curve is a fitting curve with the Logistic Function.

$$f(x) = \frac{1}{1 + e^{\beta(\alpha-x)}}. \quad (\text{II.1})$$

Based on the curve fitting, we decided on ranges for parameters of the corresponding psychometric function II.2:

$$\psi = \gamma + (1 - \gamma) \left[\frac{1}{1 + e^{\beta(\alpha-x)}} \right]. \quad (\text{II.2})$$

Our implementation of the maximum likelihood procedure uses a brute-force search or a gridding of parameter values of this psychometric function. Based on the fitted curve, we chose a grid size of 10 values for α , the midpoint of the psychometric function, in the range of [3.5,10.0]; a grid size of 3 values for β , the slope of psychometric function, in the range [1.0,2.5]; and, a grid size of 2 values for γ , the false alarm rate, having values 0 and 0.1. Our initial target gap in the procedure was 10 seconds and the total number of trials for each facing direction was 30.

Participants

Twelve participants, six males and six females, with ages ranging from 20 to 45 years old, participated in the experiment. Participants all had normal sight and hearing. None had a significant amount of experience with roundabouts or virtual environments.

Materials and Apparatus

The experiment was conducted in a 29 by 23 ft room. The virtual environment of the Pullen-Stinson Roundabout with monaural sound was presented by an NVIS nVisor SX Head Mounted Display (HMD) with headphones. The resolution of the HMD is 1280 x 1024 (SXGA) pixels per eye, a Field Of View (FOV) of 60° diagonally, and a frame rate of 60Hz. An interSense IS-900 precision motion tracker is used to update the participants rotational movements around all three axes. Position is updated using 4 optical tracking cameras working with 2 LED lights, and an update rate of 60Hz. A tracking server receives

position and orientation data from sensors and transfers them to a rendering machine. Based on that, the rendering machine generates the graphics that are displayed to a participant wearing the HMD in an immersive virtual environment.

Procedure

All participants learned the virtual roundabout environment by looking around and traversing the crosswalk back and forth one time without traffic. Then an example of traffic flow was shown to them. Participants understood that although cars would decelerate for them as needed when they actually crossed the street, they were required to assume that drivers were not willing to yield to them when they made the crossing decision, and they were responsible for seeking a safe and comfortable gap to cross, so that running across the intersection was not necessary.

The task of the experiment is to cross the street back and forth at least 60 times, 30 times in each direction. One street crossing is one trial. Any invalid trials were repeated, which typically made a number of trials more than 60. Participants were initially directed to an exit leg (point A in Figure II.1), where the simulated traffic stream would pass by. Participants were asked to cross the street in two directions alternately. On even-numbered trials, participants walked from the curb to the splitter island facing north (from A to B in Figure II.1). On odd-numbered trials, participants walked from the island back to the starting position facing south (from B to A in Figure II.1). Participants were not required to go to the opposite side of the street (which would involve crossing the entry lane to the roundabout). Since invalid trials were repeated, if all the required trials on one side had terminated, while the other side did not, more dummy trials were added on the finished side, but with a long target gap that would result in a success; thus, go decision. The experiment terminated when there were at least 30 valid crossings in each direction. And total number of crossings, including invalid and dummy trials, are equal for both sides.

In each trial, once the participant was ready, the experimenter started a scheduled traffic

flow. Participants were required to select a safe gap between cars, so they could cross the street sometime after the first car passed. Note crossing before the first car is invalid. The entire traffic flow in one trial continued until all the scheduled cars entered the roundabout, passed the participant, and left the roundabout, no matter whether and when the participant crossed the street. Once participants had initiated a crossing, they were not allowed to step back and needed to finish crossing, even if they felt it was not the right decision. If participants could not find a safe gap between cars in a particular trial, they could eventually cross after the entire traffic flow ended. Upon arrival at the destination, the participants turned around and prepared for the next trial. According to the participants response in this trial for this crossing direction, the system scheduled a traffic stream for the next trial.

For each trial, and independently in each crossing direction, before the traffic scenario started, the system determined the target gap size and when the target gap would begin. If the participant initiated a crossing before the target gap arrived, there was a good chance that vehicles would yield to the participant, so the target gap would not begin at the scheduled time point and the trial was considered invalid. For valid trials, the ending time point of the target gap was the beginning time point of the target gap plus the target gap size. We recorded the time points when pedestrians started and finished crossing the street. If the starting crossing time was between the gap beginning and ending times, it was a successful response. Given such a successful response, if the finished crossing time was also between the gap beginning and ending times, then it was also a safe crossing; otherwise, it was an unsafe crossing. If the start crossing time was later than the gap ending time, we assumed the participant would not find a more comfortable gap than the target gap - by design, such gaps were extremely short - and would wait until the traffic stream ended to cross. This condition was a failure response. There was no feedback from the experimenter to participants, such as whether or not the crossing was successful and whether or not the gap that they chose was safe.

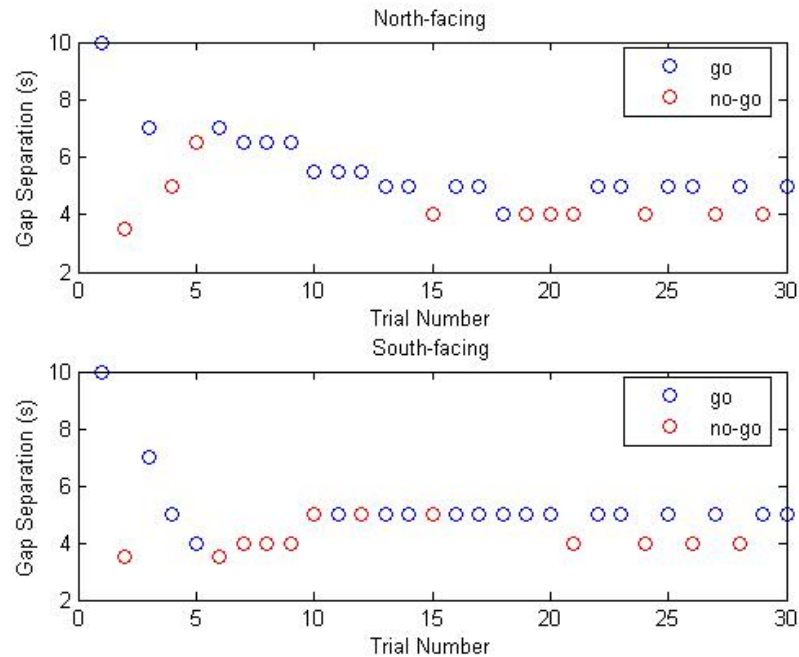

Figure II.5: An example of result. The top chart shows the trials for the north facing direction and the bottom chart shows trials for the south facing direction. Blue circles indicate that the participant crossed and red circles indicate that the participant did not cross at the target gap.

Results

Figure II.5 shows a set of trials for one of the participants. The top chart shows the level of the next stimulus for the trials in the north-facing direction and the bottom chart shows the level of the next stimulus for the trials in the south-facing direction. Red circles represent failures to cross (no-go) and blue circles represent successful crossing (go). In the north-facing direction, for example, the initial stimulus was 10 seconds of gap separation. Given the go response for the first stimulus, the next stimulus level dropped to 3.5 seconds and then the participant decided to not go. This way, the stimulus selections gradually converged to between 4.0 and 5.0 seconds over the course of the experiment. The last stimulus was 5.0 seconds of gap separation with a go response, and the final discrimination threshold was 4.0 seconds (not shown in the chart). The same pattern applied to the south-facing direction for this participant.

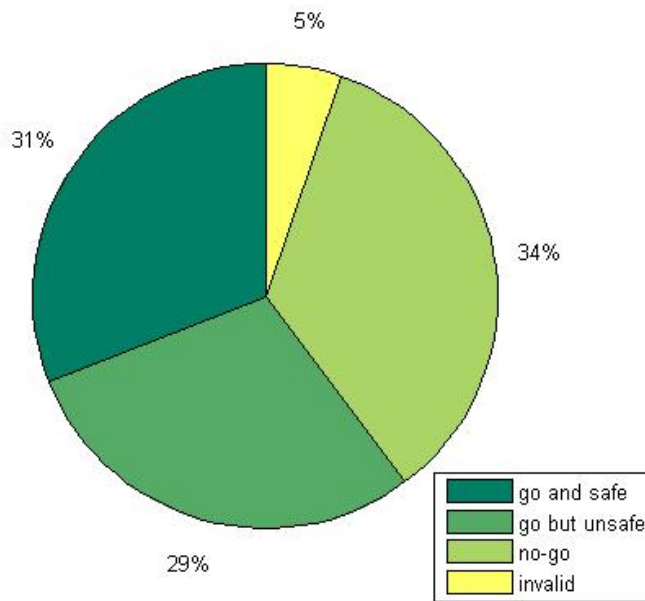

Figure II.6: The distribution of street crossings for all participants in both directions. Successful crossings accounted for 60% of the total number of crossings.

Figure II.6 shows the overall distribution of street crossings in our experiment. The 12 participants each finished 60 valid trials, in addition to 40 invalid trials, for a total of 760 trials. There were 458 successful crossings and 262 failures to cross in all valid results. The rates of successful, failed, and invalid responses are 60.26%, 34.47%, and 5.26%, respectively. Of all successful crossings, the number of safe crossings was 236, and the number of unsafe crossings was 222. Note that the experimental procedure was decided to put participants in scenarios on the border between safe and unsafe crossings, so this similarity in numbers is, in some sense, by design, with the large number of failures being the cases where the participants opted not to cross because they could not determine the safety. The fact that cars did not yield at all is another factor to comparing these results to real-world examples.

Over all the participants, the mean discrimination threshold for the north-facing crossing was 4.04 seconds [SE=0.18]; the mean threshold for the south-facing cross was 4.12 seconds

[SE=0.16]. There was no significant difference between these means (t-test, $p=0.78$). Combining these results, the overall mean discrimination threshold was 4.08 seconds [SE=0.11]. These results only take into account success and failure responses, but not safe and unsafe crossings. For successful and safe crossings, the average minimal gap is 4.37 seconds [SE=0.29] in both north and south directions. This result is close to the overall mean discrimination threshold. The average minimal gap of successful but unsafe crossing is 3.59 seconds [SE=0.06] in both directions.

We calculated the latency of crossing, which is the time that elapsed between the beginning of the target gap and the start of street crossing; and the crossing time, which is the time from when participants started crossing to when they finished crossing. The mean latency in successful crossings was 1.50 seconds [SE = 0.09]. The mean crossing time for successful crossings was 2.90 seconds [SE=0.12]. Note that this crossing time was less than the target gaps, which were 3.5 seconds and above, and thus, consistent with the literature that people will select gaps greater than the length of time it takes to cross (Ashmead et al., 2005).

Discussion

In street crossings not mediated by a traffic control signal, such as typically occur at a roundabout, pedestrians will judge an appropriate gap in oncoming traffic to choose when to initiate a street crossing. This paper examined the minimal gap at which pedestrians would cross the intersection 75% of the time and found a mean gap of 4.08 seconds. We found no effect of the direction of crossing (Figure II.1, A to B vs. B to A) on participants' decisions regarding gaps in traffic. This result is consistent with our prior work on time-to-contact (Seward et al., 2007).

One drawback of this study is that the limitations of the horizontal field of view restrict the ability of the participants to see as much of the entering lanes of traffic as they would were the field of view closer to their natural one. Also, considering that pedestrians are likely

to be more conservative when in a real physical environment with real vehicles, participants may have underestimated their crossing gap in comparison with the real world. Considering this possible bias, we feel that our results agree well with the 6 seconds finding of Ashmead et al. (2005) for normally sighted individuals crossing a road of similar width.

Although, this paper only studies individuals with normal sight, the ability to judge gaps in traffic at roundabouts is particularly important for people with visual impairments, because of the lack of traffic control. This work represents the validation of virtual environments, allowing us to explore the role of perception in pedestrian performance, particularly the effects of low vision. Auditory cues are particularly important for such individuals and adding realistic auditory effects was done in Chapter III. Roundabouts offer confusing auditory cues, because the circulating path can mask salient cues for the pedestrian.

CHAPTER III

SIVE paper: 3D Sound Rendering in a Virtual Environment to Evaluate Pedestrian Street Crossing Decisions at a Roundabout

Preface

In the baseline system presented in Chapter II, the same monaural sound of moving vehicles was sent to both ears of participants through the headphone of the HMD. Only the intensity of the sounds changed, depending on distances between vehicles and the participant. But in a real-world roundabout, sound emanating from a moving vehicle may provide viable cues for decision-making in circulating traffic contexts. In order to improve the IVE, three-dimensional spatialized sound was added to the system. Additionally, we assessed pedestrians' street crossing decisions when supplied with spatialized sound cues, and more specifically, to determine how such ability impacts the visual perception.

A sound wave undergoes complicated transformations as it travels from its source to the left and right ear canals of a listener. These transformations, called head-related transfer functions (HRTFs), are specific to each individual. But measuring individual HRTFs is currently laborious and impractical for widespread use in IVEs. We implement the non-individual HRTF filter coefficients of the KEMAR mannequin published by the MIT Media Lab (Gardner and Martin, 1995). KEMAR data lookup required the spatial information in azimuth, elevation, and distance related to the listener. A sound source (recorded engine sound) was attached to a model of a vehicle, as well as its spatial information. To provide a pedestrian with 3D traffic sounds, the acoustic simulation calculated those spatial data along each vehicle's animation path and applied the HRTF filter to the attached sound source signal. All soundtracks from each moving vehicle were mixed for both left and right ears/channels to synchronize traffic sounds in real-time.

We conducted two experiments in the same IVE as Chapter II, but in different auditory

and visual conditions. Vision is well known to dominate spatial cognition, so we blurred the visual environment for better assessment of the auditory effects. The first experiment accessed the effect of both spatialized sound and visual field degradation on gap crossing behavior. Eight participants experienced four traffic crossing conditions in counter-balanced order. The conditions were as follows: with visual blur and spatialized sound, with blur but no spatialized sound, with spatialized sound but no blur, and with no blur and no spatialized sound. The blur condition made the periphery vision blurred and left 10° Field Of View(FOV) in the center clear. The results showed that a substantial blurring of the visual image led to an increase in the average accepted gap duration, while spatialized sound made the mean gap duration slightly longer. The interpretation of this finding is that vehicle sounds may make the scenario more realistic, perhaps shifting the criterion for accepting gaps upward, toward longer gaps. This result is consistent with ratings made by the participants that the sound added to the realism of the simulation.

The second experiment focused on determining the effect of spatialized sound on people's performance. Another eight participants experienced two test conditions, the traffic simulation with and without spatialized sound. For both conditions, a participant's entire view was blurred. Compared to the image blur in the first experiment, the expanse and severity of visual blur were increased to discourage participants' dependency on visual information, thereby isolating any effect of spatialized sound. In this experiment there was a marginally significant difference in that the mean gap with spatialized sound was shorter than without. This finding suggests that participants attempted to use the sound information, but that this information has limited reliability.

Overall, our results are consistent with prior work on audio in immersive virtual environments that show an increase in subjective satisfaction with spatialized audio, but little improvement in task performance. This work was presented at the Workshop on Sonic Interactions in Virtual Environments (SIVE) at IEEE Virtual Reality 2017 in Los Angeles, CA, USA (Wu et al., 2018a).

Introduction

People can determine the location of objects and the distance to objects by auditory cues alone (Loomis et al., 2002; Zahorik et al., 2005), although this ability is not as well developed as localization using visual cues. However, sound localization may be more frequent in people with low or impaired vision (Loomis et al., 2012). In this paper, we investigate this ability in the context of street crossing behavior; more specifically, we determine how such ability trades off against vision in the context of selecting gaps in traffic for crossing the street.

We present an immersive virtual environment (IVE) simulation for traffic crossings at a roundabout. This simulation incorporates a system for rendering three-dimensional (3D) spatialized sound. While acoustic virtual environments have been demonstrated for some time, e.g. (Wenzel and Foster, 1990; Astheimer, 1993), this paper presents our architecture for a general, distributed real-time system for spatialized sound in the context of an HMD-based, immersive virtual environment and application.

We chose a roundabout for our traffic crossing scenario, because roundabouts are seen in the United States as increasingly desirable intersection designs due to improved safety and efficiency features over traditional intersections (Board et al., 2007). Although roundabouts are generally considered safe, particularly for vulnerable populations (Ashmead et al., 2005), pedestrian behavior at these intersections has been understudied. Meanwhile, a rich body of literature has developed using IVEs to evaluate both pedestrian and cyclist interactions with traffic to improve safety (Plumert and K. Kearney, 2014; Morrongiello et al., 2015; Jiang et al., 2016; O'Neal et al., 2017). IVEs are ideal for this type of research, since real world traffic studies expose pedestrians to unnecessary risk by involving actual, moving vehicles. IVEs are appealing for traffic studies due to the control they give experimenters and the safety they afford participants.

However, these traffic simulations have largely been limited to linear intersections, such as that discussed in K. Kearney et al. (2006), and typically do not provide spatialized sound.

More realistic auditory information may inform how people interact with traffic simulations. Our IVE consists of a system for sound localization, and it generates more complex traffic patterns by using a traffic circle environment (Wu et al., 2009).

In addition to the roundabout environment, our setup consists of a controllable traffic simulation and a 3D acoustic subsystem. The roundabout is modeled after a real location, the Pullen-Stinson roundabout on the North Carolina State University campus. It models a single lane traffic circle with crosswalks and splitter islands placed near entry and exit lanes. The traffic simulation generates natural vehicle acceleration and deceleration patterns, based on information taken from the location (Rouphail et al., 2005). To this system, we have added a 3D acoustic subsystem capable of synthesizing the sounds associated with moving vehicles, and we are able to track the sounds' locations in the environment in real-time. Our audio system uses a non-individual head-related transfer function (HRTF), derived from the anthropomorphic audiological research mannequin KEMAR (Knowles Electronics) (Burkhard and Sachs, 1975).

We anticipate that the acoustic system may affect our simulation in two ways. First, it may increase a user's sense of presence and immersion in the environment. An enhanced sense of immersion is desirable as it promotes more ecologically valid judgments from participants. Stated in another way, by enhancing the realism of our traffic simulation, we can elicit more natural responses from participants. This realism provides better information about pedestrian behavior in the real world.

As mentioned, we are interested in studying the traffic crossing behavior of participants with visual impairments. It is likely that people with visual impairments use auditory cues to aid with their traffic judgments, although the evidence for this is mixed (Cheong et al., 2008), and vision, even when impaired, seems to dominate our sensory information. However, by adding a sound system to our virtual environment that allows people to localize sounds, we have the ability to test and assess this phenomenon in a manner similar to the evaluation of HRTFs for visually impaired and normal people conducted by Dong et al. (2017). Thus,

although our experiments will use normally sighted individuals, we will introduce mock visual impairments to degrade the visual quality of their viewing experience to see if they will then employ the available auditory cues. This is motivated by evidence that such spatial memory cues are independent of the source (visual or auditory) from which they are derived (Loomis et al., 2012).

The remainder of this paper is organized as follows: Section 2 reviews prior literature and places our current work in context. Section 3 presents the details of the 3D audio system as well as a description of the traffic simulation and virtual environment. Section 4 presents two psychophysical experiments to evaluate the 3D audio system, and Section 5 discusses our results and presents future goals for the project.

Related Work

A sound wave undergoes complicated transformations as it travels from its source to the left and right ear canals of a listener. These transformations, called head-related transfer functions (HRTFs), are specific to each individual but can be approximated by non-individual ones, such as the approximation used in Kolarik et al. (2013). There is some degradation in the quality of the 3D sound caused by this approximation, but measuring individual HRTFs is laborious and impractical for widespread use in IVEs. Overviews of this subject can be found in Begault (1994) and Xie (2013). Suarez et al. (2017) compared a version of the measured KEMAR HRTFs used here with modelled HRTFs in an IVE over several tasks and found no differences. In particular, our work applies measured HRTFs to a dynamic affordance (gap crossing).

The ability to represent large numbers of dynamic sound sources has become more viable with the ability to implement binaural rendering using a Graphical Processing Unit (GPU) to improve computational efficiency (Taylor et al., 2012; Belloch et al., 2013). These binaural sounds can be presented through either headphones (Hiipakka et al., 2012; Lindau and Brinkmann, 2012; Sunder et al., 2015) or by loudspeaker via crosstalk cancellation

systems (Lacouture-Parodi and Habets, 2012; Majdak et al., 2013). To enhance immersion and spatial orientation, HRTF-based binaural sound has been used widely in both augmented reality (Ranjan and Gan, 2015) and virtual reality (Schissler et al., 2016). Applications using spatialized sound have been developed to help the visually impaired navigate architectural spaces (Picinali et al., 2014) and virtual maps (Geronazzo et al., 2016). In this paper, we implement the non-individual HRTF filter coefficients of the KEMAR mannequin published by the MIT Media Lab (Gardner and Martin, 1995). For HMD-based virtual environments, HRTF-based systems fed through earphones seem the obvious choice due to their compact form factor.

There has been much work evaluating spatialized audio in desktop virtual environments, e.g. (Bormann, 2005, 2006), and in IVEs (Doerr et al., 2007; Naef et al., 2002). In desktop environments presence has been found to increase with the inclusion of spatialized audio, but quantitative task performance measures, such as task completion time, have been unaffected. Riecke et al. (2009) also found that presence can be increased by spatialized sound. However, neither Naef et al. (2002) nor Doerr et al. (2007) used HRTFs for sound localization.

Virtual traffic crossing experiments often quantify the assessment of immersion by evaluating gap affordance judgments in traffic (Plumert et al., 2007; Plumert and K. Kearney, 2014; Grechkin et al., 2013; O'Neal et al., 2017). When individuals cross a street, whether in reality or in a simulation, they must select a suitable gap in between vehicles to cross. To prevent collisions with oncoming vehicles, this gap must afford them sufficient time to physically locomote across the street before the next vehicle approaches. The assessment of traffic crossing behavior has important ramifications for the design of traffic intersections. For example, this information can be used to better design intersections to accommodate for vulnerable populations, such as children and the visually impaired, who can make poor gap judgments.

System Design

Virtual Environment

The experiments were conducted in a 7.3m by 8.5m laboratory. The virtual environment was presented by a full color stereo NVIS nVisor SX Head Mounted Display (HMD) with 1280 x 1024 resolution per eye, a nominal FOV of 60° diagonally, and a frame rate of 60Hz. As opposed to newer commodity-level HMDs, this HMD was equipped with an Arrington eye-tracker, although it was not employed in these experiments. An interSense IS-900 precision motion tracker was used to update the participant's rotational movement around all three axes. Position was updated using four optical tracking cameras that operated with two LED lights. The virtual environment displayed in the HMD was rendered in Vizard (Worldviz, Santa Barbara, CA).

Traffic Simulation

Roundabouts are traffic junctions where vehicles enter a circulating one-way stream of traffic around a central island. Instead of following a traffic control signal, vehicles must proactively yield to both upstream traffic and pedestrians. Pedestrians never walk through the circulating path or cross the center island. They only access designated crosswalks at the entry and exit lanes. Modern roundabouts have been statistically reported to reduce the severity of vehicle-to-vehicle crashes (Daniels et al., 2010).

Our roundabout environment is an accurate, graphic street model of the Pullen-Stinson roundabout on North Carolina State University campus. Additional environmental features, such as buildings and vegetation, were added to the environment for realism; however, these additions were not based on the real world location. Prior work has utilized this same street model for the evaluation of street crossing behavior with nonlocalized sound in individuals with normal eyesight (Wu et al., 2009). A bird's-eye view of the virtual environment is shown in Figure III.1, and the environment seen from normal eye height with traffic approaching is shown in Figure III.2. Prior observation of traffic in the real



Figure III.1: An overview of our virtual environment, modeled on the Pullen-Stinson roundabout, showing traffic circulating. Pedestrians cross at the walkways.



Figure III.2: View of car approaching the traffic crossing from the eye-height of one of the authors, and shows the several of the car models used in the simulation.

Pullen-Stinson roundabout showed that the average approaching speed of vehicles was 15.6m/s (35 mph) and the circulating speed was 8.0m/s (18 mph) (Rouphail et al., 2005). In our virtual environment, approaching vehicles gradually reduce speed from 13.5m/s (around 32 mph) to 7.5m/s (around 17 mph), maintain 7.5m/s in the circulatory roadway, and then gradually resume to 13.5m/s upon exiting the traffic circle. Complicating this behavior further are provisions for vehicle-vehicle interactions and vehicle-pedestrian interactions. A vehicle avoids collisions with other vehicles by using a predetermined forward sight distance and an intersection sight distance. For vehicle-pedestrian interactions, each vehicle yields to pedestrians in the crosswalk area. More details of the traffic simulation can be found in Wu et al. (2009).

Audio Simulation

The 3D acoustic subsystem applied HRTF measurements of KEMAR dummy head microphone (Gardner and Martin, 1995) to simulate sound source interactions within the acoustic environment. The KEMAR measurements sampled a total of 710 different positions, and yielded impulse responses at a 44.1 kHz sampling rate, 512 samples long, and stored as 16-bit signed integers. There were two concurrent processes in the audio simulation. One

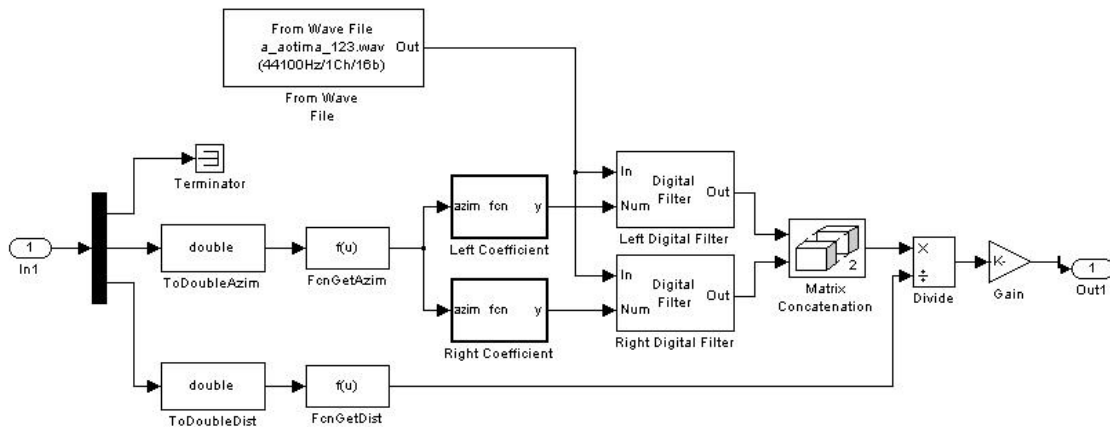

Figure III.3: The Simulink implementation of the HRTF filter.

process updated each sound source's position relative to the listener. This was accomplished by collecting the positional data of each vehicle in relation to the position of the pedestrian in the virtual environment. The other process linked the individual sound source positions with different sound source signals and applied the digital filters specified by KEMAR data to the sound source signals. This computational system was built in Simulink (MathWorks, Natick, MA).

For our system design, we assumed that sound emanated isotropically from an object. Thus the orientation of the vehicle models had no effect on their sound. Instead of their absolute x, y, and z coordinate values, KEMAR data lookup required the spatial information in azimuth, elevation, and distance related to the listener. To generate a synchronized soundtrack for traffic animations, the azimuth and distance of each moving vehicle were calculated along an animation path and updated in real-time. Values between the sample points were rounded to the nearest sample point. We simplified the elevation by assuming it to be a constant value of 10 degrees, although this was not an intrinsic limitation of the system. This spatial information was packed and sent from Vizard to Simulink over a UDP connection. No significant time delay was found between these two modules, and no packet

loss over the local intranet was experienced.

In Simulink, a sound source signal was attached to a model of a vehicle as was its spatial information, which was received from Vizard. Sound source signals came from real engine noise recordings (cf. Baldan et al. (2015)). We recorded eight different vehicles for each of the eight vehicle models in our system. These recordings were made of the car from outside the car with the car stationary at a constant engine speed. A sampling frame of recorded sound was selected based on the update rate of the positions. And the appropriate KEMAR filter coefficients for each ear were selected based on the values of the positions. The KEMAR filter and the sound source were then convolved, and the left and right channels were combined into binaural audio.

A significant auditory cue for distance is the sound level (Ashmead et al., 1990). Accordingly, we scaled the sound level as the reciprocal of distance with the measured intensity at a distance of 1m. We used a sound level meter to calibrate each sound volume. Measurements were done with a dB-A scale slow setting using a RadioShack sound level meter (Cat. No. 33-2055A), with the average volume set to 70dB at 5 meters. Figure III.3 demonstrates the Simulink implementation for a single vehicle. The current filter pair and loudness scale were replaced whenever new spatial information was received. Input was processed for each vehicle individually, and then all synthesized 3D sounds mixed to a set of shared signal busses. Finally, both visual output from Vizard and audio output from Simulink were delivered through the HMD and into earbuds simultaneously. We used Klipsch S4 earbuds.

Experiment and Results

We conducted two experiments to assess our sound system. Because vision so dominates spatial cognition, we blurred the visual environment severely in some conditions for better assessment of auditory effects. Sixteen total participants, eight males and eight females, with ages ranging from 20 to 29 years old participated in the experiments with eight participants participating in each experiment. Experimental groups were gender-balanced, and all



Figure III.4: Blurred displays experienced by participants in Experiment 1 (left) and Experiment 2 (right). In both scenes the view is from the side of the road with a car approaching. Notice that while the lead car can be seen, as in Figure III.2, details of further cars are obscured in both cases.

participants self-reported normal sight and hearing. In both experiments, all conditions were within-subjects. No participant reported a significant amount of experience with virtual reality.

Experiment 1

Our first experiment attempted to assess the effect of both spatialized sound and visual field degradation on gap crossing behavior.

Procedure

Experiment 1 used a 2x2 design. Participants experienced four traffic crossing conditions in counter-balanced order. The conditions were as follows: with visual blur and spatialized sound, with blur but no spatialized sound, with spatialized sound but no blur, and with no blur and no spatialized sound. For the blur condition, a simulation of glaucoma-like damage was presented, where the periphery was blurred and 10 degree FOV in the center was clear. The blur was set so that moving objects could be reliably discerned at 8 to 10 meters. An image of the blur effect for Experiment 1 is displayed in Figure III.4 on the left-hand side.

Before the experiment began, written consent was obtained from all participants. Par-

ticipants were introduced to the roundabout environment, the crosswalk, and all of the conditions during a brief learning phase within the IVE. During the experiment, participants performed a series of trials to determine their gap threshold, or minimum safe gap crossing threshold. The gap for each trial was determined using a maximum-likelihood procedure (MLP) similar to that of Grassi and Soranzo (2009). The participant crossed the street 15 times, which was sufficient for the ML procedure to converge.

For each trial of the experiment, a stream of traffic with a randomly chosen number of cars between 4 and 8 passed through the roundabout. Each adjacent car maintained a gap with less than 2 seconds between it and the next, except for the car that was assigned the designated target gap. This safe gap allowed for a time between 3 and 12 seconds in length. The position of the longer gap was randomly assigned in the traffic stream each time. For each condition, the participant was required to execute 15 street crossings. These limits were all determined through pilot testing. At the velocity the vehicles were traveling, 2 seconds is not sufficient for a pedestrian to safely cross the street, and 12 seconds is more than sufficient. The threshold at which people choose to cross lies somewhere in between. What will happen in this type of ML procedure is that the system will automatically adjust the gap threshold to make the next crossing a more difficult choice for each participant — longer if the prior response was a not to cross the target gap, and shorter if the prior response was to cross — based on the participant's prior history of responses. This procedure will converge in the 15 traffic crossing trials to that participant's gap crossing threshold, the minimum gap at which they are likely to cross. See Wu et al. (2009) for further details.

Participants were instructed to select a safe gap in traffic and to act upon this selection by physically walking across the virtual street. Participants were told that, although the cars would not hit them, the drivers did not want to yield to them and that they should seek *the first* available safe gap in traffic. In all trials, the true gap, the participant's time to cross, and whether the participant actually made a safe crossing assuming no yielding on the part of a vehicle were recorded. We also administered questionnaires asking participants' qualitative

impressions of the conditions.

Table III.1: Mean gap crossing time for Experiment 1 in seconds.

		Sound	
		<i>Yes</i>	<i>No</i>
Blur	<i>Yes</i>	5.75	5.69
	<i>No</i>	5.06	4.62

Results

In Experiment 1, with $n=8$ and the dependent variable as the gap duration of the converged ML procedure, we ran an analysis of variance (ANOVA) with blur and sound as the factors. The only significant effect was the main effect of blur: $F(1, 7) = 5.8136, p < 0.0467$. The mean gap duration was 4.84 seconds with no blur and 5.72 seconds with blur. As expected, a substantial blurring of the visual image led to an increase in the average accepted gap duration. The difference was approximately 1 second, which would be functionally significant in a busy traffic setting.

An interesting possibility suggested by the results of this experiment is that one effect of adding sound is to increase the accepted gap duration. This effect is shown in Table III.1, which presents mean gap duration by condition. In the condition with no blur, mean gap duration was actually longer with sound than without (although the difference was not statistically significant). This result is consistent with ratings made by the participants, that the sound added to the realism of the simulation.

So there may be counteracting effects of adding sound. On one hand, the sound may provide information that is useful for perceiving gaps, which could lead to better perception and shorter accepted gap duration. On the other hand, vehicle sounds may make the scenario more realistic, perhaps shifting the criterion for accepting gaps upward, toward longer gaps. Qualitatively, seven of eight participants preferred the (sound, no blur) environment over all

others, the eighth preferring (no sound, no blur).

Experiment 2

Our second experiment focused on determining the effect of spatialized sound on people's performance.

Procedure

Experiment 2 followed a similar experimental procedure to that seen in Experiment 1. However, this time a participant only experienced two test conditions, the traffic simulation with and without spatialized sound. For both conditions a participant's entire view was blurred.

The expanse and severity of visual blur was increased to discourage participant dependency on visual information, thereby isolating any effect of spatialized sound. This blur was extended throughout the entire screen, incidentally simulating a severe visual impairment. The blur factor was also increased so that discernibility was decreased further to approximately 5 meters. An example of the blur effect may be seen in Figure III.4 on the right-hand side.

The aspects of the experimental procedure for Experiment 2 not explicitly discussed followed that of Experiment 1. Experimental data and questionnaires were likewise collected in the same manner as in Experiment 1.

Results

In Experiment 2, with $n=8$ and the dependent variable as the gap duration of the converged ML procedure, the mean gap with sound was 5.81 seconds and without sound was 6.63 seconds. A paired sample t-test was marginally significant, $t(7) = 2.154, p < 0.068$. In this experiment there was very substantial blur in both the sound and no sound conditions. Not surprisingly, gap thresholds were generally higher than in the previous experiment.

Figure III.5 shows a set of trials for one of the participants. The top chart shows the

level of the next stimulus for the trials in the condition without sound and the bottom chart shows the level of the next stimulus for the trials in the condition with sound. Red circles represent failures to cross (no-go) and blue circles represent successful crossing (go). In both conditions, the initial stimulus was 12 seconds of gap separation. Over the course of the experiment, the stimulus selections gradually converged to 7.5 seconds without sound, and to 4.5 seconds with sound.

In this situation, a premium may be placed on extracting acoustic information about gaps, when that information was present. Thus, although the difference in gap thresholds between the sound and no sound conditions was not quite at the 0.05 level of statistical significance, the average thresholds were about 0.8 seconds lower when sound was available. This suggests that participants attempted to use the sound information, but that this information has limited reliability. Qualitatively, six of eight participants preferred sound over no sound, one expressed no preference, and one preferred no sound.

Discussion

Our results are consistent with prior work on audio in virtual environments that show an increase in subjective satisfaction with spatialized audio, but little improvement in task performance (Riecke et al., 2009; Bormann, 2006). It may be that, even in the blurred condition, participants are able to extract enough optic flow information to make vision the dominant modality, and our results may suggest that participants find audio localization unreliable. Nonetheless, the subjective improvement in the virtual environment from the presence of spatialized sound is clear.

Quantitatively, our results are more ambiguous. It is generally acknowledged that using generalized HRTFs, such as the KEMAR ones used in this study, can result in degraded localization performance in users (Middlebrooks and M. Green, 1991; Møller et al., 1996). There is some evidence that the localization performance laterally is only minimally impacted by the use of these generalized HRTFs (Romigh and Simpson, 2014),

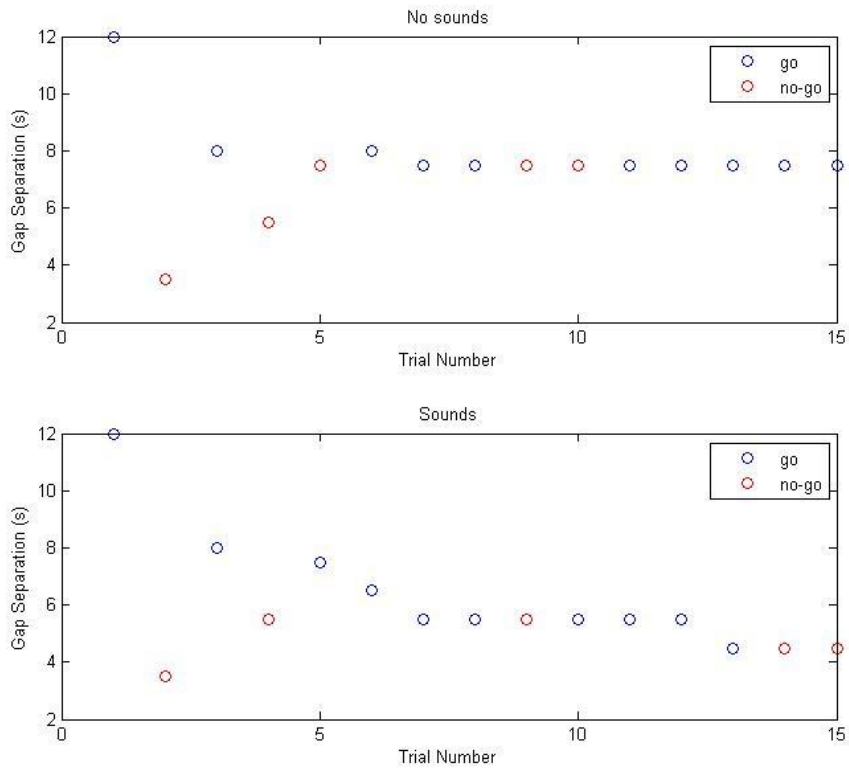

Figure III.5: Results for one of the participants.

although how this impacts moving targets is unclear. However, the generalized nature of the HRTFs employed in this work represents a limitation of our system and study, and employing more modern computational techniques to personalize the HRTF (Geronazzo et al., 2015; Yamamoto and Igarashi, 2017) is a clear area for future work. It may be that isolating the localizing ability of spatialized sound in IVEs requires larger experimental power than employed in this study, another avenue for future work.

CHAPTER IV

ACM paper: Using Virtual Reality to Evaluate Pedestrian Street Crossing at a Roundabout

Preface

In this chapter we improve the traffic simulation by adding more travel paths. Given the definition of exiting traffic (vehicles exiting through the leg where a pedestrian is waiting to cross) and circulating traffic (vehicles exiting through the leg next to where a pedestrian is waiting to cross), our prior simulation generated only exiting traffic, while the new simulation generated both exiting and circulating traffic. As a result, the new traffic simulation included six travel paths that come from three different entry lanes and leave through the two different exit lanes in the roundabout virtual environment. Pedestrians cross the street at the first exit lane.

Consider two successive vehicles: if the first one circulates and the second one exits, the perceived gap starts as soon as the pedestrian identifies the first car to circulate when it is still in the circulatory roadway. If the first one exits and the second one circulates, the perceived gap would never end and bond with the next gap. In both cases, a vehicle's travel path make the perceived time gap longer in the traffic stream. We want to assess if and how pedestrians take advantage of crossing opportunities from circulating traffic.

The expanded traffic simulation used the same traffic schedule mechanism and added the ability to set different traffic paths. In a scheduled stream of traffic, every vehicle was assigned an a priori probability to continue circulating, except that the first and the last cars always exited the roundabout to where the pedestrian was waiting. In these studies, we used three probabilities (0%, 25%, and 75%) as three conditions of the experiment to vary the possibility that a vehicle would circulate. The experimental task was the same as in the prior work — participants were to find a safe and comfortable gap in traffic to cross the street.

The results showed that high rates of circulating traffic induced pedestrians to select a smaller target gap to cross the street, sometimes as a non-target gap or an unsafe crossing. It confirmed our hypothesis that people will make use of the extra time that circulating traffic brought. The fact that people became less cautious with the increase in circulating traffic may be due to a careless strategy or the complexity of the traffic. Notably, there were gender differences in our results: male participants tended to take more risks so that they selected shorter gap, waited less time before crossing, and crossed the street more rapidly.

The primary difference in experimental procedure between the 0% circulating traffic condition in this experiment and our very first baseline experiment was spatially rendered sound vs. monaural sound. The results suggested that the effect of adding spatially rendered sound is to increase the mean gap threshold. In fact, all the mean gap thresholds in the three circulating traffic conditions (5.136 seconds [SE=0.512], 4.804 seconds [SE=0.414], 4.539 seconds [SE=0.386]) are longer than that in the baseline study II (4.083 seconds). This finding is consistent with our first experiment in the 3D sounds study III, where the blur view was present in the periphery.

With the traffic simulation update, the system has ability to simulate reasonable traffic patterns by controlling individual vehicles route and timing. This work is under review at the *ACM Transactions on Applied Perception* (Wu et al., 2019).

Introduction

Virtual environments can be used to simulate real world situations, especially situations that would be difficult to study systematically in the real world. For example, flight simulations (Lee, 2006) and driving simulations (Kemeny and Panerai, 2003) are examples where the cost and complexity of real world training make virtual simulations desirable, and the technology has been successfully applied in these domains. Virtual environments have also been used to study pedestrian and cyclist behavior at intersections successfully. For example, Plumert et al. (2004) and Chihak et al. (2014) conducted crossing experiments in a large

screen virtual environment and compared street crossing performance between children and adults. We are also interested in using virtual environments to study pedestrian behavior in complex traffic situations. The present study uses a Head-Mounted Display (HMD) based virtual environment to investigate the user performance in road crossing decisions against various patterns of traffic at a roundabout.

Roundabouts are road intersections where traffic approaches from several directions, converges to move into one direction around a central island, and then exits to different directions again. We are particularly interested in street crossing behavior at the exit lane of a roundabout because the decision about crossing is complicated. Exiting drivers rarely yield to pedestrians (Ashmead et al., 2005; Inman et al., 2006; Guth et al., 2005, 2013) and there can be uncertainty about whether a vehicle will travel down the exit lane or continue in the rotary circle. Our prior work (Wu et al., 2009, 2018a) created an immersive virtual environment modeled on a real roundabout with traffic simulation providing vehicle-vehicle and vehicle-pedestrian interactions. This study expands on our prior work and improves the traffic simulation in the roundabout virtual environment by involving more vehicle travel paths with different exit lanes.

In road crossing judgments where there is free running traffic, a pedestrian must find a suitable gap in the traffic which they believe affords safe crossing of the street. In a roundabout circumstance, sound locating cues may provide nuance in representing circulating traffic contexts. To increase a user's sense of presence and immersion in the environment, this study included the acoustic subsystem from our prior work (Wu et al., 2018a), capable of synthesizing the spatialized sound associated with moving vehicles in real-time by reproducing the sound locating cues. In general, our findings show that people are sensitive to the circulating traffic condition and can take advantage of it, but may not always make the best decision when traffic circulates.

Background

Safe street crossing requires pedestrians to judge whether there is sufficient time to cross before the next vehicle arrives. The elderly and children are the two most vulnerable populations of pedestrians. Connelly et al. (1998) asked children standing at the roadside, in real traffic settings, to indicate the moment at which they would no longer cross the street in front of the approaching vehicle. The results revealed that young children (aged below 10 years) were more likely to make risky crossing decisions, particularly when vehicles approached at high speed (exceeding 50kph). Oxley et al. (1997) discovered that pedestrians over the age of 65 years took longer to make traffic judgments and adopted a less safe crossing manner, particularly in the complex situation of a two-way road.

The act of crossing the street requires two sequential steps: 1) a traffic gap judgment; and 2) crossing behavior. te Velde et al. (2005) assessed participants' ability to visually judge traffic gaps as well as their adaptive walking behavior in an experimental setup including a laboratory road and approaching bicycles. The results indicated that verbal judgments about when to cross cannot fully represent actual road crossing since crossing behavior involved calibration of perception and action. Participants made more unsafe decisions on the judgment task than they did on the crossing task, which indicates the actual crossing task may prevent producing high risk decision results.

Virtual reality provides a promising environment for perception-action studies such as road crossing, where timing and location of traffic is controllable. Schwebel et al. (2008) found some validity in using a desktop virtual environment when comparing virtual results to those of the real world for road crossing behavior in children. Lobjois et al. (2013) used a large screen immersive display to assess gap selection in younger and older groups, finding that regardless of age, people select a shorter second gap if they miss the first gap. Morrongiello et al. (2015) used virtual reality to determine that children were capable of evasive action in crossing through traffic streams.

Plumert and colleagues (Plumert et al., 2004; Chihak et al., 2014; Plumert and Kearney,

2014; Nikolas et al., 2016) have studied road crossing behavior of cyclists at intersections, particularly child cyclists. They use a large screen immersive virtual environment with an interactive bicycling simulator. In general, this body of work reveals that road crossing is a developmental process and that young children and adolescents make riskier choices than adults. This group has also studied pedestrian road crossing behavior in children and adults, both as solitary individuals (O'Neal et al., 2018) and in dyads (Jiang et al., 2018).

In addition, Lobjois and Cavallo (2009) used a three-screen projection virtual environment to investigate the street crossing behavior of the elderly. They found that people over the age of 65 tend to take more risks crossing the street. Dommes and Cavallo (2011) used the same virtual environment to study the underlying age-related declines that affect the elderly to calibrate their traffic perception with their crossing action.

Traffic crossing behavior has also been studied using immersive virtual environments presented through head-mounted displays (HMDs). A trade-off that these devices offer is that real locomotion can occur in a study, but the field of view is often smaller. For example, Simpson et al. (2003) reported the consistent findings with previous studies that young children (under 10 years of age) tend to take more risks with road crossings. Clancy et al. (2006) is the first research study to compare road crossing behavior of teenagers (13 to 17 years old) with and without Attention Deficit Hyperactivity Disorder (ADHD). This study revealed that participants with ADHD had overall worse performance such as making more unsafe road crossings.

A series of real-world examinations have been conducted focusing on the accessibility of modern roundabouts for blind people. Guth et al. (2005) asked blind and sighted participants to provide only judgments of when they would have made crossings. Blind pedestrians appear to make more unsafe crossing judgments and miss more crossable opportunities than sighted pedestrians, especially in the roundabouts with higher levels of traffic activity. The major challenge for blind participants was masking noise from background traffic. Ashmead et al. (2005) analyzed the actual street crossing of blind and sighted pedestrians.

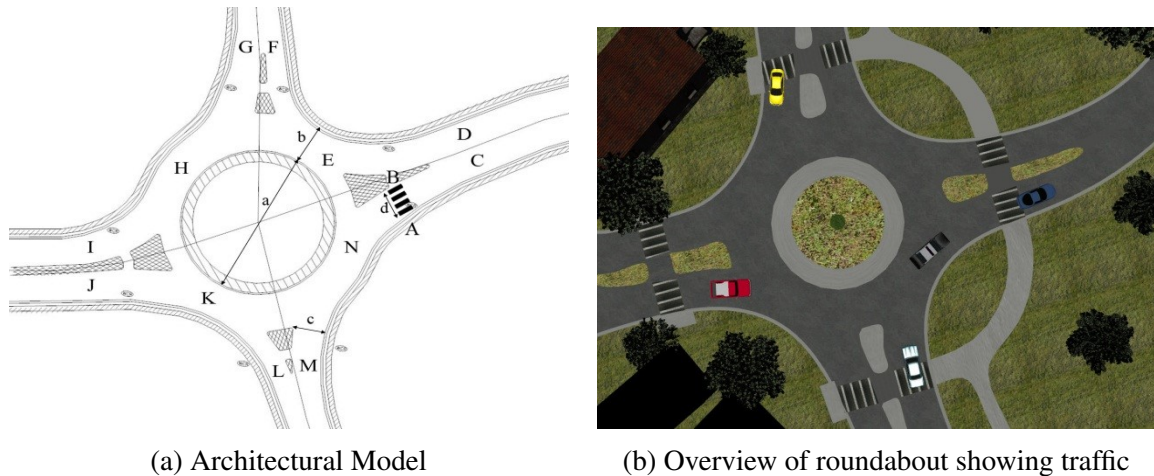

Figure IV.1: Model of the Pullen-Stinson roundabout

Blind pedestrians reported that they couldn't make unassisted crossing at a double-lane roundabout under high traffic volumes, experiencing increased risk and delays than sighted pedestrians. The performance was especially poor in the area of exit lanes, as drivers were less likely to yield exiting the roundabout. To focus on single-lane roundabouts, Guth et al. (2013) conducted a crossing judgment experiment for blind and sighted pedestrians, and their investigation led to similar conclusions as Guth et al. (2005) and Ashmead et al. (2005). In addition, they revealed that blind pedestrians made fewer risky judgments at locations farther from the roundabout. Based on these findings, designing crosswalks further away from roundabouts may benefit all pedestrians, but especially the visually impaired.

Roundabout Virtual Environment and Traffic Simulation

System Basis

Our roundabout environment was modeled on the Pullen-Stinson roundabout in Raleigh, NC. As shown in Figure IV.1, it has a single lane plan, with splitter islands that separate the entry and exit lanes. The traffic simulation conformed to the traffic regulation in terms of speed limits, yielding the right-of-way, and maintaining a space cushion. The system used a single strategy for all vehicles but employed eight vehicle models to generate traffic streams as demand. All the time gaps between moving vehicles were configurable. One of them was

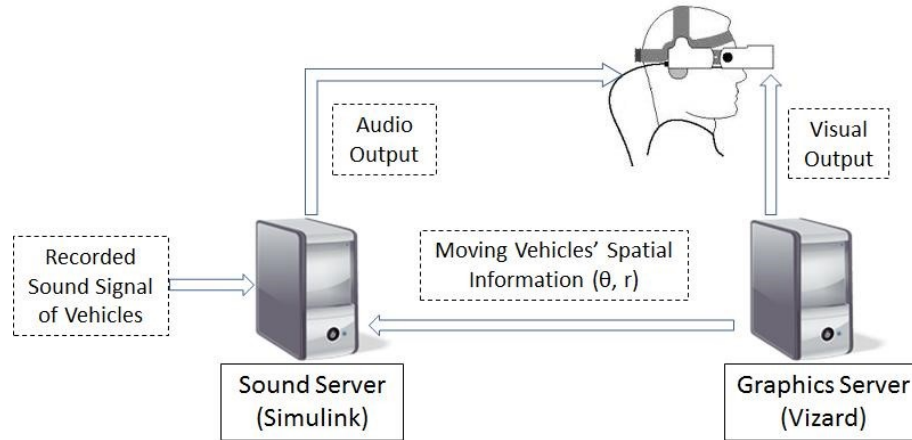

Figure IV.2: The simulation system including graphics and audio generation

designated as the *target gap*, that we were interested whether pedestrians would select to cross the street at an exist lane. Its value ranged between 2 and 12s. Other gaps in traffic were set to be shorter than 2s, which we have found experimentally to be shorter than people will use to cross the street. More details about this traffic roundabout virtual environment can be found in our prior work, Wu et al. (2009). Figure IV.2 shows the architecture of the whole system. The virtual environment was rendered in Vizard (Worldviz, Santa Barbara, CA), whereas the audio simulation was built in Simulink (MathWorks, Natick, MA). The audio simulation provides real time spatialized sound for moving vehicles using non-individual head-related transfer functions, as described in our prior work, Wu et al. (2018a).

Circulating Traffic

When pedestrians start to cross an exit lane, e.g., point A in Figure IV.1a, there are three critical travel paths resulting in exiting vehicles, along which vehicles' travel must be checked: Figure IV.3a shows the right-turn path, e.g., a vehicle moving through points $M \Rightarrow N \Rightarrow C$; Figure IV.3b shows the straight-through path, e.g., $J \Rightarrow K \Rightarrow N \Rightarrow C$; and IV.3c shows the left-turn path, e.g., $G \Rightarrow H \Rightarrow K \Rightarrow N \Rightarrow C$. Our prior work (Wu et al., 2009) had these three travel paths only. We simplified the traffic by not including the path of $D \Rightarrow E \Rightarrow H \Rightarrow K \Rightarrow N \Rightarrow C$, where vehicles enter the roundabout through the same leg where the

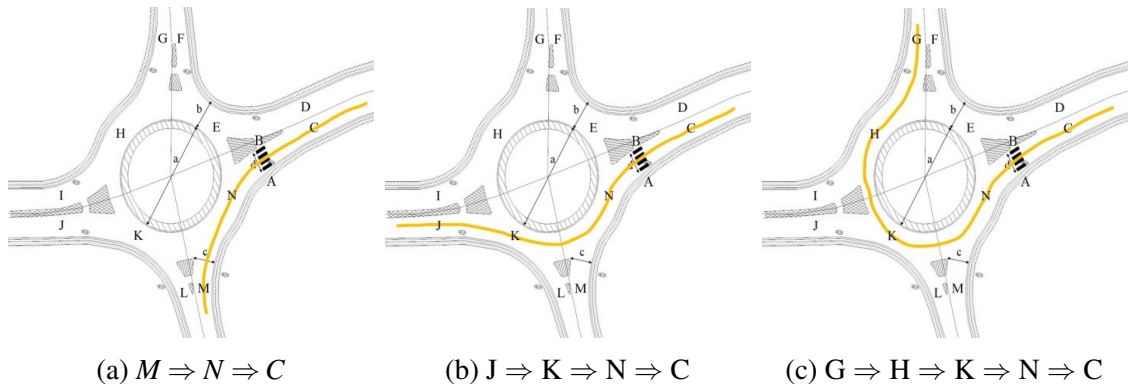

Figure IV.3: Exiting traffic paths

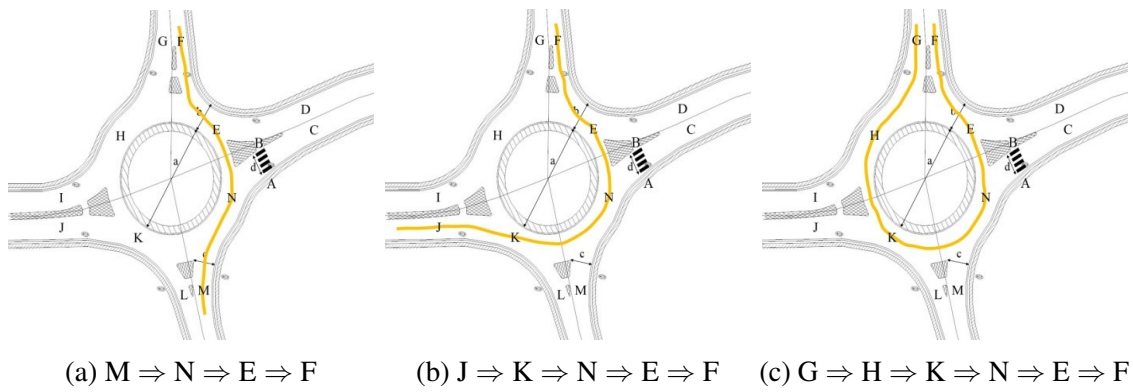

Figure IV.4: Circulating traffic paths

pedestrian is waiting. This path occurs when a driver wants to reverse direction on the same street, but it is unusual.

Considering more complicated and realistic situations for pedestrians at point A, not all vehicles that have traveled to point N will exit to point C. Some of them will bypass the exit lane that the pedestrian wants to cross, instead continuing to circulate to point E or beyond. To observe whether this behavior will affect pedestrians' crossing decisions, we added three more travel paths: Figure IV.4a, $M \Rightarrow N \Rightarrow E \Rightarrow F$; Figure IV.4b; $J \Rightarrow K \Rightarrow N \Rightarrow E \Rightarrow F$; and Figure IV.4c, $G \Rightarrow H \Rightarrow K \Rightarrow N \Rightarrow E \Rightarrow F$. These three paths are simply those from Figure IV.3, but with exit at point F, the next street after the one the pedestrian is on. This way, the pedestrian must contend with approaching vehicles that may or may not use the lane the pedestrian is trying to cross.

In summary, our system simulates traffic in six travel paths that come from the three different entry legs (M, J, and G), and leave through the two different exit legs (C and F). To distinguish them, we name the traffic exiting through point C *exiting traffic*, and name the traffic exiting through point F *circulating traffic*. Considering both categories of traffic, a vehicle will either begin to exit the roundabout or continue to circulate in the roundabout from point N, which we call the *turning point*.

A time gap is measured as the amount of time between the center of one vehicle passing a point and the center of the next vehicle passing. Given all vehicles in traffic, including circulating traffic, would pass the turning point N, we chose N as the measurement point for gap durations in a traffic stream, i.e., a point to measure temporal spacing between one car and the next. This way the time between vehicles passing the turning point N sets the gap duration independent of whether each circulates or exits, as this gap is the one by which pedestrians effectively make crossing decisions.

Traffic Trial Update

The system was programmed so that a stream of vehicles could be scheduled and launched as a trial. When generating a traffic trial, we need to determine which car(s) will exit at point C and which will circulate to point E (Figure IV.1a), as we neglected more complicated circulating behavior. Every vehicle was assigned an a priori probability to continue circulating instead of leaving the roundabout, except that the first and the last cars in a trial sequence always exited the roundabout through point C. When the system randomly selects a travel path for a vehicle, it uses this constraint of circulating probability. The target gap, mentioned in Section IV, was controlled to be accurate at point N in Figure IV.1a, a point visible from the crosswalk and just before a vehicle would turn to exit or continue circulating on the roundabout. Figure IV.5 shows an example of a traffic scenario including circulating traffic.

From the view point of a pedestrian who is waiting at the exit of the roundabout (point A in Figure IV.1a), if any vehicle circulates, the following gap that actually can be used to



Figure IV.5: An example of an updated traffic scenario. Blue rectangles represent vehicles moving from left to right. Vehicles 1, 3, 5 will exit and vehicles 2, 4 will circulate. A target gap is randomly set between the 2nd and the 3rd car for 5 seconds.

cross the street will be longer than the gap set by the system. Because the street crossing movement can be started as soon the pedestrian identifies the oncoming car as circulating immediately after the turning point N. In busy traffic, pedestrians must make rapid decisions about this aspect of vehicle movements to take advantage of crossing opportunities.

Experiment and Results

Design and Protocol

The purpose of this experiment was to systematically explore the effect of adding circulating traffic, that is, that is, vehicles that continued in the circulatory roadway rather than turning into the exit lane that the pedestrian is waiting to cross. The primary independent variable was the probability that a vehicle would continue in the circulatory roadway rather than travel down the exit lane. We manipulated this probability to be 0%, 25%, or 75%. Although 0% circulating probability occurs rarely, it provides a baseline result, comparable to the condition in our prior study (Wu et al., 2009). The 25% and 75% circulating probabilities represent low and high rates of circulating traffic, respectively. Gender was also a factor in this experiment.

The task for participants was to judge an appropriate gap in oncoming traffic and cross street in the virtual roundabout environment. This experiment followed a similar procedure as our prior study (Wu et al., 2009). Participants were instructed to find a safe gap so that they felt comfortable crossing with a normal walking speed. And once the crossing had begun, participants were not allowed to step back and needed to finish crossing. If a subject

could not finish crossing before the next vehicle approached, the vehicle would yield until he or she finished crossing. If a subject could not find any gap in a trial to cross, he or she would eventually have a chance to cross after the entire traffic stream had passed. We did not encourage participants to be either ambitious or apathetic.

An outcome for a given trial was deemed a *go* if the pedestrian started crossing during the *target gap*. A *no-go* outcome occurred if the pedestrian started crossing after the *target gap* ended, including the case that he or she waited until all gaps went by. Under *go* conditions, a safe crossing indicated the subject finished the crossing behavior before the *target gap* ended (if the vehicle yielded for the pedestrian, the safe decision was nonetheless based on what the gap duration would have been without yielding). Otherwise, the outcome fell into the *unsafe crossing* category. An *invalid* outcome occurred if the pedestrian started crossing during a gap preceding the *target gap*, in which case that stream was invalidated and repeated in later trials.

Since there was no effect of walking direction in our prior study, we did not record separate results for each direction in this experiment. For each condition, we used a maximum likelihood procedure to estimate discrimination threshold of gap selection (Grassi and Soranzo, 2009). Given the gap selections easily converged within 20 trials from the experimental data of our prior study, in this experiment, we conducted 20 of trials for each condition per subject to estimate the gap threshold. In this manner, each subject completed 20times3 trials of street crossing across all three conditions.

For all *go* outcomes, the system recorded the time points at which a pedestrian started and finished crossing the street. This resulted in two dependent variables. One is the *curb delay*, the time elapsed from the beginning of the observed target gap to the initiation of street crossing. The other is the *crossing time*, the elapsed time between the start crossing time and the finish crossing time (the *crossing time* does not include the *curb delay*). For each trial, we recorded whether the subject crossed the street in the *target gap*, the *curb delay* and the *crossing time*. Then for each condition, with 20 trials finished, we calculated

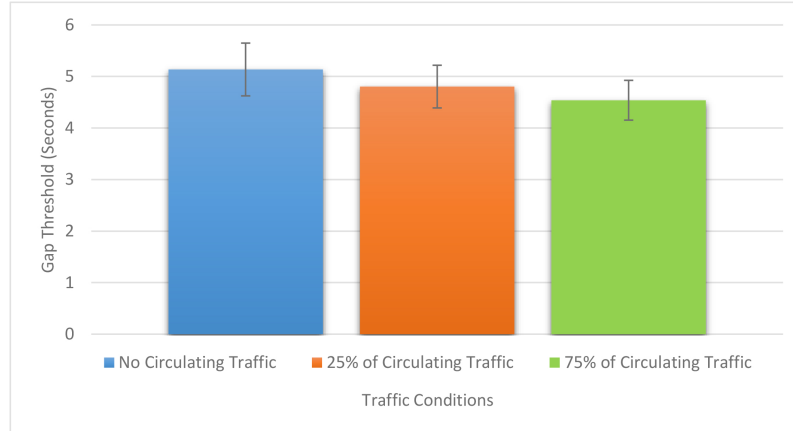

Figure IV.6: Gap threshold variance by circulating traffic conditions

gap thresholds, average curb delays, and average crossing times for this subject.

Hypothesis

We had two hypotheses for this experiment. First, we expected that pedestrians would discern that traffic streams high higher rates of vehicles that circulated, and would therefore overall have smaller target gaps as the circulating probability increased. The reason for this hypothesis was two-fold. We believed that people would be able to discern that relatively few cars were turning down their exit lane and would be more aggressive in crossing. Our second hypothesis is simply that pedestrians will take advantage of circulating traffic and initiate their crossing immediately after they observed a circulating vehicle followed by a crossable target gap. The first hypothesis should show up as a decrease in target gap duration with the increase in circulation probability. If the first hypothesis is confirmed, then the second will follow if there is no change in the curb delay measure across the circulating conditions.

Apparatus and Participants

The experiment was conducted in a 7.3m by 8.5m laboratory. The virtual environment was presented by a full color stereo NVIS nVisor SX Head Mounted Display (HMD) with

1280 x 1024 resolution per eye, a nominal FOV of 60 degrees diagonally, and a frame rate of 60Hz. As opposed to newer commodity-level HMDs, this HMD was equipped with an Arrington eye-tracker, although it was not employed for these experiments. An interSense IS-900 precision motion tracker was used to update the participant's rotational movement around all three axes. Position was updated using four optical tracking cameras that operated with two LED lights. The virtual environment displayed in the HMD was rendered in Vizard (Worldviz, Santa Barbara, CA). The 3D acoustic subsystem was built in Simulink (MathWorks, Natick, MA) and applied HRTF measurements of KEMAR dummy head microphone (Gardner and Martin, 1995) to simulate sound source interactions within the acoustic environment. This acoustic system is fully described in Wu et al. (2018a).

Twelve subjects (six male, six female) participated in the experiment, all reporting normal vision and hearing, aged from 22 to 33. Each subject experienced all three conditions (0%, 25%, and 75% probabilities of circulating) in a counter-balanced order (two subjects in each of the six possible orders).

Results and Analysis

Table IV.1 lists the gap thresholds, curb delays, and crossing times by circulating condition for all participants, and also broken down by gender.

The mean gap thresholds were 5.136 seconds (SE=0.512) for no circulating traffic; 4.804 seconds (SE=0.414) for 25% circulating traffic; and 4.539 seconds (SE=0.386) for 75% circulating traffic (also see Figure IV.6). The mean gap threshold selected by male subjects was 3.92 seconds (over all circulating conditions); and 5.73 seconds by female subjects (again, over all circulating conditions). A two-way mixed repeated analysis of variance with circulating probability (0%, 25%, 75%) and gender as independent variables showed main effects of circulating probability, $F(2, 20) = 4.286$, $p < .028$, and gender, $F(1, 10) = 7.106$, $p < .024$, with no interaction.

The result is consistent with our first hypothesis that high rates of circulating traffic

Table IV.1: Key measures in seconds

Condition	Gap Threshold		Curb Delay		Crossing Time	
	<i>Mean</i>	<i>SE</i>	<i>Mean</i>	<i>SE</i>	<i>Mean</i>	<i>SE</i>
No Circulating	5.136	0.512	1.454	0.241	3.241	0.198
<i>Male</i>	4.031	0.108	0.907	0.084	2.931	0.126
<i>Female</i>	6.241	0.807	2.002	0.359	3.552	0.344
25% Circulating	4.804	0.414	1.515	0.224	3.359	0.229
<i>Male</i>	4.009	0.192	1.066	0.165	2.990	0.136
<i>Female</i>	5.600	0.682	1.964	0.336	3.729	0.398
75% Circulating	4.539	0.386	1.355	0.128	3.287	0.187
<i>Male</i>	3.721	0.101	1.077	0.124	2.938	0.161
<i>Female</i>	5.357	0.616	1.633	0.160	3.637	0.282

will induce pedestrians to select a smaller target gap to cross the street. Unlike our prior study (Wu et al., 2009), there were gender differences in this experiment. Male subjects tended to take more risks so that they selected shorter gaps, waited less time before crossing, and crossed the street more rapidly. Schiff and Oldak (1990) also reported gender-based differences, where women exhibited more conservative behavior and were less accurate to men with their traffic estimation. There is some consistency between Schiff's estimation results and our behavior results.

Over all go outcomes, there was no discernible effect of circulating probability on either curb delay or crossing time. To quantitatively evaluate this across the circulating condition, we used Bayes factors, which can provide support for the null hypothesis, expressing that evidence as an odds ratio. We employed the methods of Rouder et al. (2009) as they take into account sample size and thus adjust for experimental power. We set the prior odds to 1, favoring neither the null nor the alternative. First, comparing the 0% condition and the 25% condition gives a Jeffrey-Zellner-Siow (JZS) Bayes factor of 4.42 indicating strong evidence in favor of the null hypothesis; comparing the 25% and 75% conditions gives a JZS Bayes factor of 2.38, which are marginal and do not strongly support either the alternative or the null; and, comparing the 0% and 75% conditions gives a JZS Bayes factor of 3.29 which does give strong evidence in favor of the null hypothesis. These findings are partially consistent with our second hypothesis that there is no effect of the circulating condition on the curb delay, but not wholly consistent with it.

We also find a gender difference on curb delay ($F(1, 10) = 9.326, p < .012$). The mean curb delay for females was 2.151 seconds (SE=0.166), which was significantly longer than that for males, which was 1.275 seconds (SE=0.071). There was no effect of gender on crossing time.

Figure IV.7 shows the gap crossing distribution by rate of circulating traffic and gender. The first row compares the distribution of gap crossings in three circulating traffic conditions. We found a higher percentage of unsafe crossings and invalid crossing with an increase in

circulating traffic. Invalid crossings happened during non-target gaps, which are shorter than any target gap. These are also consistent with our hypotheses that high volume circulating traffic will induce pedestrians to select a smaller gap to cross the street, either as a non-target gap or an unsafe crossing. In the second row, we also found male subjects had more unsafe crossings and invalid crossings than female subjects.

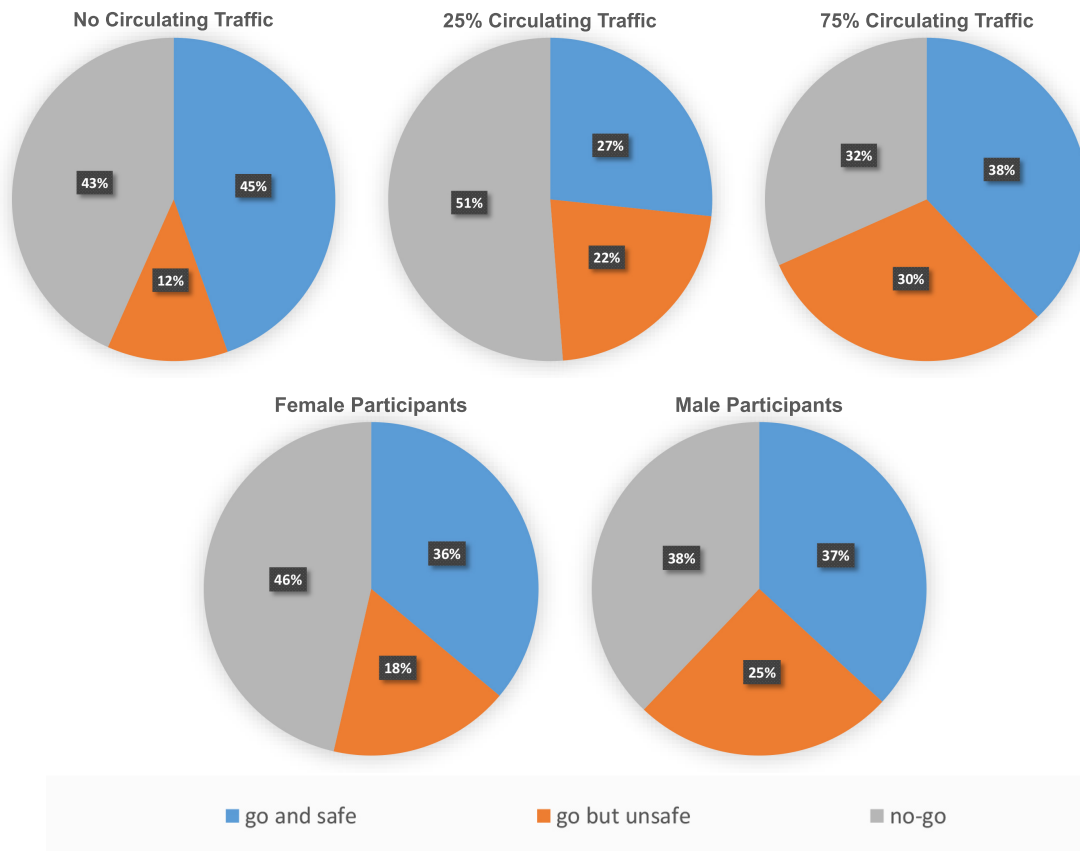

Figure IV.7: The distribution of street crossing by group

Discussion

This paper presented results of an experimental assessment of gap perception in a roundabout traffic environment under ambiguous traffic conditions, where the traffic could either exit, or circulate. Gap perception is a critical behavior for travelling and wayfinding in urban environments. Controlled studies of such perception provide important insights into the factors governing such behaviors. An immersive virtual environment provides an opportunity

to study the effect of different proportions of circulating traffic in roundabouts in a systematic way that would be difficult or impossible to approximate in a “live” traffic setting.

Our findings showed that people were sensitive to the circulating traffic condition. Higher rates of circulating traffic led to overall lower size of target gap selections. People may be deciding to cross the street as soon as they can determine that the first car in a gap is going to circulate instead of turn, without paying as much regard to the true gap between the cars. Or the perceptual problem may be more difficult. Whatever the reason, as the rate of circulating traffic goes up and the mean target gap goes down, the rate of unsafe crossings increased. This was significant in males.

There are several possible explanations for why people became less cautious with the increase in circulating traffic, as shown by the increase in unsafe crossings. One explanation is that people expect that some subjects make a crossing judgment based simply on whether the vehicle at the turning point circulates or exits, and begin crossing once they saw the vehicle circulate, without regard for any vehicles behind it. Thus the complexity of the roundabout may make their perception and decision process less accurate. A contributing factor to this lack of accuracy, of course, may be the limited field of view of the HMD. Another possibility is that people more frequently misjudged the behavior of the traffic, since we did not allow them to retract their decision once they had made it, that is, they were not allowed to make a false start. Future work is needed to determine the reasons for this behavior.

The primary difference in experimental procedure between our prior study (Wu et al., 2009) and the 0% circulating traffic condition in this experiment was monaural sound vs. spatially rendered sound. An interesting possibility suggested by the results of these two experiments is that the effect of adding spatially rendered sound is to increase the mean gap threshold. In fact, all the mean gap thresholds in the three circulating traffic conditions (5.136 seconds, 4.804 seconds, 4.539 seconds) are longer than that in our prior study (4.083 seconds). This result is consistent with the ratings made by the participants that

the spatially rendered sound added to the realism of the simulation. It is also consistent with Bernhard et al. (2008), who found participants from conditions with spatially rendered sound tended to wait longer before they selected a crossable gap in oncoming traffic, compared to participants in stereo and mute conditions. Bernhard et al. (2008) attributed this to an increased awareness of virtual danger in an immersed audio-visual environment.

A minor difference between the two experiments was that our prior study went on for 60 trials (30 trials for each direction condition) whereas this experiment went for only 20 trials (per circulating traffic condition). To eliminate the possible partial effect, we went back to the first experiment's data and used the target gap values on trial #21 (the mean value for both direction conditions), which would correspond to the gap threshold we used in this experiment. Then we compared gap thresholds across two experiments. The mean gap threshold for the first 20 trials in our prior study (4.103 seconds) was shorter than the mean gap threshold for all 20 trials in the 0% circulating traffic condition in this experiment (5.136 seconds).

We hypothesized that people would exploit the opportunities presented by circulating traffic. We found some evidence for this hypothesis in the curb delay when the circulating conditions were compared to the condition in which traffic that did not circulate, but this hypothesis did not receive strong support when compared from a low circulating condition to a high circulating condition. It could be that people become more uncertain in high circulating conditions, but that our experiment did not have the resolution to determine this. More work in this area is needed.

Going forward, we will focus on improving the system in terms of providing better user experience and establishing a stronger connection between perception and action. First, because of the restriction of the horizontal field of view in the HMD used in this study, but even in modern commodity level HMDs, one drawback of this study is the limited ability of subjects to see as much of the entering lanes of traffic as they would if the field of view were closer to their natural one.

CHAPTER V

Frontiers paper: Using Virtual Reality to Assess the Street Crossing Behavior of Pedestrians with Simulated Macular Degeneration at a Roundabout

Preface

Macular degeneration is an incurable eye disease that leads to central vision loss, typically in people over age 60. The eye disease caused by the deterioration of the central portion of the retina and results in a scotoma, a grey or black spot in the middle of an afflicted person's vision. Clear central vision is essential for observing fine detail, and central vision deficits affect performance in daily activities, such as reading and walking. Visually impaired pedestrians are, thus, vulnerable populations, especially in a roundabout, because of the lack of traffic control. We are interested in how well people afflicted with macular degeneration identify gap crossings at roundabout intersection. However, recruiting macular degeneration patients to human behavior studies raises safety issues, as the patients are usually elderly people with limited mobility and sometimes balance issues. In this chapter, we added a visual deficit simulation to the IVE of the previous chapters. The simulation allows us to expose normally sighted participants to a first-person virtual experience of central visual field loss of variable size, in the form of a simulated scotoma. We are able to investigate how the gap crossing decisions of individuals with normal vision were affected by the simulated central vision loss.

Macular degeneration often causes variable shape and size of relative scotomas and absolute scotomas, an area of the visual field with degraded visual acuity in various stages. A relative scotoma can be simulated by blurring images and an absolute scotoma can be simulated as an opaque spot. Our visual deficit simulation generalizes a model of macular degeneration through the combination of a blur and opacity filter, which is expressed by a circle of a black area within a circle of a blurred region. The shape, size, and the degree

of blur can be controlled to represent different stages of the disease. Using a stereoscopic HMD equipped with an eye-tracker, the simulated scotomas can be associated with gaze position provided by the eye-tracker in real-time, which makes scotomas always centered above the foveal region.

The assessment task for participants was still judging an appropriate gap in oncoming traffic and crossing the street. However, the visual conditions were varied. Thirty-six participants, including eighteen males and eighteen females aged from 18 to 31 years old, were randomly assigned to one of the three visual conditions: normal vision (zero scotoma), which provided baseline results; 10° of visual angle of absolute scotoma with 20° of visual angle of relative scotoma; and 20° of visual angle of absolute scotoma with 40° of visual angle of relative scotoma. The results indicated that a larger size of scotoma caused people to choose longer gaps between traffic and to wait longer before initiating a crossing. In addition, a gender difference was found, where male participants tended to take more risk, as indicated by the selection of shorter gaps in traffic and a shorter delay before the initiation of a crossing.

By simulating a controllable scotoma coupled with low visual acuity, we were able to simulate the main characteristics of foveal vision loss that is characteristic of macular degeneration. Our findings generally replicate those of studies conducted in real-world conditions using participants afflicted with genuine central vision loss, supporting the hypothesis that virtual reality is a safe and accessible alternative for investigating similar issues of public concern. We focused on macular degeneration in this study, although the system has the ability of simulating other types of vision deficits. This work was published in *Frontiers in Virtual Environments*, 2018 (Wu et al., 2018b).

Introduction

Virtual Reality (VR) provides an effective medium for the study of human behavior. The appeal of this technology lies in its capacity to control environmental factors. VR also finds

applications in research where conducting an experiment may be too dangerous or infeasible for real-world execution. Thus, VR has been used to investigate pedestrian behavior at intersections (Clancy et al., 2006; Seward et al., 2007; Bernhard et al., 2008; Morrongiello et al., 2015; Meir et al., 2015). Real traffic scenarios present unnecessary risk to participants and are difficult to control for accuracy. Contributing to previous virtual traffic research, we conducted an investigation into the ability of pedestrians to make street-crossing decisions under a simulated visual impairment. In contrast to prior studies, our virtual environment consists of a roundabout, rather than a traditional, linear intersection, because the ability of a pedestrian to judge sufficient openings, or gaps, in traffic is essential for crossing the street at circular junctions safely. For the visually impaired and other vulnerable populations, this ability may be compromised, resulting in unsafe decision making at these special crossroads. This concern is motivated by real-world studies (Ashmead et al., 2005), which have established that blind individuals make poor gap judgments at traffic roundabouts. Accordingly, this population has been of interest for behavioral analysis within the domain of pedestrian safety.

We are interested in how macular degeneration, in particular, affects performance and safety in pedestrian situations. Macular degeneration is a medical condition that primarily affects older populations and results in vision loss to the center of the visual field. This loss is due to the deterioration of the macula, which lies near the center of the eye's retina. The resulting degradation of visual acuity, or scotoma, may present itself as a partial vision loss or complete occlusion. Clear central vision is essential for observing fine detail, and central vision deficits affect performance in daily activities, such as reading and walking (Ergun et al., 2003; Hassan et al., 2002). At present, macular degeneration accounts for 8.7% of all blindness worldwide and is the most common cause of blindness in developed countries (Wong et al., 2014). Alarming, the number of people worldwide with age-related macular degeneration alone is projected to rise to 196 million by 2020, advancing to 288 million by 2040.

In an effort to aid in determining the extent to which macular degeneration affects the movement and safety of afflicted pedestrians, we analyzed pedestrian performance at a roundabout intersection without traffic signal guidance. To achieve this goal, we embedded a simulation of our desired visual deficit into an immersive virtual reality application. Both our experimental setup and virtual environment were inspired by prior literature, which analyzes gap crossing judgments in order to evaluate pedestrian safety (Wu et al., 2009). We define gap crossing as the selection of a break in the traffic stream, followed by traversal of an intersection. By exposing normally sighted individuals to this first-person experience and assessing their gap crossing behavior, we were able to investigate the effect of macular degeneration on gap crossing judgments.

Thus, this study simulates a visual impairment (macular degeneration) in a virtual traffic crossing to assess a vulnerable population's ability to make critical judgments on issues of safety. Recruiting a population with actual visual impairments for either real-world or virtual studies is problematic, as this population is often elderly and may have balance issues that limit use of head-mounted displays (HMDs). Further, the limited contrast range of most HMDs makes viewing difficult for such a group. It may, therefore, be more effective to simulate the visual impairment and use healthy participants. Likewise, the virtual traffic simulation itself provides a safe means of studying a dynamic and potentially hazardous phenomena under controlled conditions. We show that our macular degeneration simulation offers a controlled and well defined model of real visual impairment; and our roundabout traffic simulation provides a realistic and safe environment.

Our head-mounted display (HMD) based virtual environment consisted of a roundabout, a controllable traffic simulation, a 3D acoustic subsystem, and a vision deficit simulation. The virtual environment modeled a single lane roundabout accompanied with crosswalks and splitter islands. The simulated traffic reproduced vehicle acceleration and deceleration patterns as well as other natural traffic interactions, such as collision avoidance and pedestrian yielding.

Background and Related Work

Street crossings and gap affordances at linear intersections in a large screen virtual environment in the context of cycling safety, with particular attention to children, has been studied by Plumert et al. (2004, 2007). They found children and adults chose the same-size gaps and yet children ended up with less time to spare when they cleared the path of the approaching car, providing evidence of a significant developmental change in affordance judgments for adolescents. Their work has also studied pedestrian behavior at such intersections (O'Neal et al., 2017) and judgments involving two lanes of traffic (Grechkin et al., 2013). In contrast to their work, our work takes place in the context of the exit lane of a roundabout, where traffic decisions can be more complex, and involves visual impairment.

Macular degeneration patients were found to have different gaze behavior, in comparison to fully-sighted people during high-risk activities (Geruschat et al., 2006). A follow-up study compared traffic gap detection among pedestrians with normal vision, central vision loss, and peripheral vision loss. While the results suggested that all groups could identify crossable and uncrossable gaps accurately, there was a significant effect of low vision in measures of latency and safety (Geruschat et al., 2011). The study also found that decisions at the exit lane of a roundabout are more difficult than those at the entry lane. These experiments, done in the real world at an uncontrolled intersection, with a handheld trigger as the indicator of deciding to cross, are best viewed as complementary to ours, which involve real locomotion in a controlled traffic simulation in a virtual environment.

By comparing normally sighted, visually impaired, and blind pedestrians' street crossing decisions, people found that visually impaired participants' performance was as accurate and reliable as normally sighted participants (Hassan, 2012). Unsurprisingly, blind pedestrians were the least accurate in making street crossing decisions. The investigation was continued among elderly people with macular degeneration, elderly people with normal vision, and young normally sighted pedestrians (Hassan and Snyder, 2012). Again, no significant differences were found between macular degeneration and age-matched, normally-sighted

pedestrians in street crossing decisions. However, the study found that macular degeneration pedestrians tended to make unsafe street-crossing decisions. Our study seeks to provide a simulation that provides normally sighted people with an understanding of the difficulties faced by these visual deficits and is behaviorally equivalent to people with visual deficits. This work is again best viewed as complementary to ours, since it involved decisions at simpler traffic intersections (the single lane of a one-way street), and used a handheld trigger as an indicator of deciding to cross. It is likely that our simulation presented visual impairments that were in a broader range of impairments, as Hassan and colleagues focused on participants with mild to moderate visual impairments.

Virtual reality has been applied to simulate visual impairments for medical training and education purposes, as well. These simulations provide first-person experiences for medical professionals to better understand the daily difficulties encountered by patients. Ai et al. (2000) and Jin et al. (2005) simulated various forms of eye diseases in the context of a virtual apartment and received positive user response. They simulated macular degeneration through the application of an opacity mask and a wavy mask. Banks and McCrindle (2008) created a similar, specialized visual eye disease simulator for architects to view their designs through the perspective of a visually impaired onlooker. This work provides engineers with a better understanding of how to design public spaces for better accessibility and easier navigation. In the study presented by Lewis et al. (2012), a Gaussian blur and a distortion shader were applied to simulate macular degeneration. They also conducted an effectiveness test that showed their visual impairment simulator improved users' understanding of visual impairments, in general. Expanding the virtual microcosm, Väyrynen et al. (2016) designed a navigation task in a city environment that allowed participants to experience various visual impairments, such as macular degeneration, cataracts, glaucoma, and myopia, in a dynamic setting.

In augmented reality, various types and levels of visual impairment have also been simulated. Through the coupling of head-mounted displays and stereoscopic cameras, Ates

et al. (2015) and Werfel et al. (2016) produced simulation tools to generate experiences using real-time video feedback. Both developments focus primarily on user experience, invoked empathy, and understanding as metrics for evaluation. While most studies recreate computational estimations of low vision experiences, an assessment tool was designed by Pamplona et al. (2011) to capture retinal information from a high-contrast light-field display. Although this information is not displayed in real-time, it is able to create an accurate depiction of the visual occlusion experienced by a participant.

The Roundabout Virtual Environment

A roundabout is a circular intersection in which an entering vehicle must adjust direction and speed in order to merge into a uni-directional traffic circle. Our environment is modeled after the Pullen-Stinson roundabout, at North Carolina State University. Figure V.1 shows a bird's eye view of the scene. Upon approach to the roundabout, a vehicle in the system gradually reduces momentum from a default speed (15m/s) to a circulating speed (7.5m/s), maintaining the circulating speed for the duration of its roundabout traversal. Upon exiting, the vehicle gradually accelerates back to the original, default speed of 15m/s. A vehicle must also avoid collisions, although our participants were instructed not to "force" such yielding.

Our system controls travel paths, start times, and velocities for all vehicles so that a variable stream of virtual automobiles may be scheduled and launched for each trial. These trials can therefore represent a variety of traffic scenarios by providing a series of time gaps between moving vehicles, based on a specified distribution. In our procedure each traffic stream includes a maximum of eight vehicles, which are randomly selected from eight distinct vehicle models.

To include both auditory and visual cues in our environment, we added a three-dimensional (3D) acoustic subsystem capable of synthesizing the spatialized sound associated with moving vehicles in real-time. Our spatialized audio rendering uses a non-individual head-related



Figure V.1: An overview of a roundabout virtual environment.



Figure V.2: Traffic view within the roundabout.



Figure V.3: Macular Degeneration simulation (a black area, 10° of visual angle, surround by a blurred area, 20° of visual angle).

transfer function (HRTF) (Begault, 1994; Kapralos et al., 2008), derived from the anthropomorphic audio logical research mannequin KEMAR (Knowles Electronics) (Gardner and Martin, 1995).

Within this HMD-based virtual environment, users can safely interact with controlled traffic streams, which allocate sufficient time for street traversal upon the event of a designated, safe time gap in traffic. A sample rendering of the pedestrian's viewpoint of the roundabout with traffic is shown in Figure V.2. More details about the roundabout environment can be found in Wu et al. (2009).

Simulating Macular Degeneration

Optical Distortions

Induced by retinal damage, macular degeneration often results in scotomas, or areas of reduced light sensitivity, in the retina. A relative scotoma, which can be simulated by blurring images, refers to an area that retains some residual light sensitivity. An absolute scotoma, which can be simulated as an opaque spot, describes the absence of any light perception. The shape and size of scotomas vary across patients. In this simulation, we generalize a model of macular degeneration through the combination of a blur and opacity filter, which is expressed by a circle of black area within a circle of a blurred region. Figure V.3 provides a sample rendering of the low-vision simulation for clarification. Our filter was implemented via the OpenGL Shading Language (GLSL) embedded in Vizard.

Central scotomas are represented by a variety of shapes including: circles, ellipses, ring-shapes, and horseshoes, as well as more irregular geometries. The majority of macular degeneration studies (Guez et al., 1993; Hassan et al., 2002) use diameters to infer scotomas, so we have generated a circle-based approximation to provide a reasonable comparison. The macula refers to an area of approximately 5-6 mm in diameter, centered on the fovea, which corresponds to the central 15°-20° of visual angle (Cheung and Legge, 2005). Our HMD has a field of view of 44° horizontally and 35° vertically, so there is a wide range to the visual angles of scotomas it can generate. Previous studies (Hassan et al., 2002; Ergun et al., 2003) have revealed that the size of the absolute scotoma correlates significantly with one's ability to perform daily tasks. Therefore, for the efficacy of our simulation, it is imperative to provide an allowance for any size of potential scotoma.

Visual acuity is another indication of a person's ability to perform a range of vision-dependent daily living tasks (McClure et al., 2000). In our system, changing the amount of blur for the relative scotoma can control visual acuity. We asked 8 people to report letters binocularly using a Snellen chart in a virtual environment. The acuity estimates were systematically related to the blur factor and fit to an exponential curve, as shown in Figure

V.4. The image transitions from clear to blur, or opacity needs to be smoothed without sharp edges. A Gaussian function was applied to define the level of blur, or opacity over the transition on edges. This type of simulation of visual deficit is consistent with other simulations of such phenomenon (Cornelissen et al., 2005; Geringswald et al., 2012).

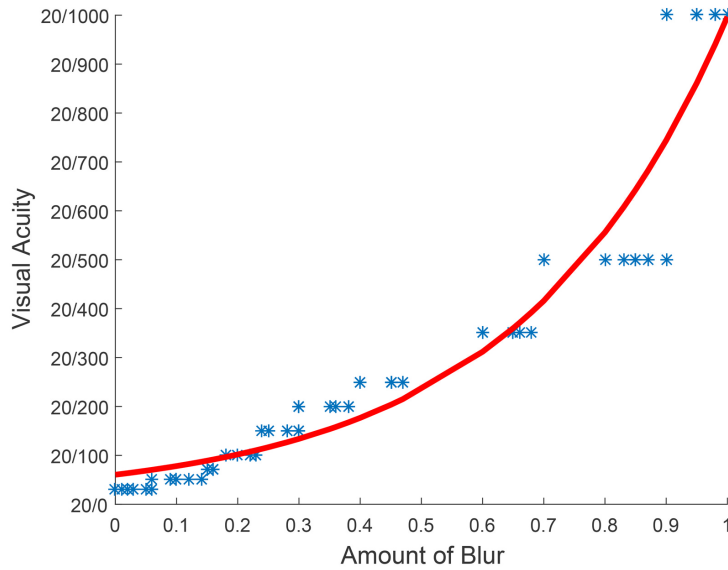

Figure V.4: Visual acuity tested by a Snellen chart (X axis represents the scale of the blur. Scale 1 makes the scene opaque and scale 0 makes the scene clear. Y axis represents Snellen fraction.)

Gaze-contingent

Scotomas frequently affect the same region of the visual field in both eyes (Cheung and Legge, 2005) and shift with eye movement in real-time. This type of degradation to the visual field in the foveal region can be simulated with a stereoscopic head-mounted display (HMD) equipped with an eye-tracker. With only a static occlusion in the middle of the display, participants may circumvent visual occlusions by looking at the clear, peripheral portion of the viewport. However, by using an eye-tracker, gaze position is provided in real-time, so that the system can link simulated scotomas with current gaze position, which allows scotomas to shift with real-time gaze movement and provides a dynamic occlusion at the center of the user’s visual field. In this paper we used an NVis SX60 HMD

equipped with an Arrington eye-tracker. The Nvisor SX-60 HMD provides 1280×1024 resolution per eye, a field of view (FOV) of approximately 47° (horizontal) by 37° (vertical) degrees, full binocular overlap, and a frame rate of 60 Hz. The HMD weighs approximately 1kg. The Arrington eyetracker provides eye tracking with infrared video. The accuracy is approximately $0.25^\circ - 1.0^\circ$ visual arc with spatial resolution approximately 0.15° visual arc. The system records the (X, Y) position of gaze at a rate between 60Hz and 30Hz. This rate is faster than the 50 milliseconds of average saccadic suppression (Volkman, 1986). The position data can be transmitted in real-time to other software applications.

The eye-tracker requires calibration, which was done at two levels. Initially, a calibration to the user was done at the system level. However, optimal calibration was difficult to maintain, given the unavoidable slippage of the HMD on the head as people turned their heads to track vehicles and as they crossed the road. To minimize this, we had participants wear silicone swimming caps underneath the HMD, and we secured the cable of the HMD to each participant with a belt. Additionally, a second, application layer calibration was conducted within the virtual environment on a per trial basis. This calibration involved participants fixating on the center of the visual field and adjusting the eyetracking to match this position.

Experiment and Results

General Design

The purpose of this experiment was to observe how our simulation affected normal-sighted individuals' street crossing decisions at roundabout intersections. In particular, we examined the time gap between vehicles where pedestrians select to cross the street — the gap threshold — under different vision conditions.

In the roundabout virtual environment, participants were asked to cross the street in an exit lane. This area is shown as the shaded area between point A and point B in Figure V.5. For that particular position, there are six paths along which vehicles travel must be checked.

These paths are depicted by yellow curves on the same figure: (1) M ->N ->C; (2) M ->N ->E ->F; (3) J ->K ->N ->C; (4) J ->K ->N ->E ->F; (5) G ->H ->K ->N ->C; (6) G ->H ->K ->N ->E ->F. The system creates traffic streams by randomly selecting travel paths for each of eight vehicles from these six paths, allowing half of the vehicles to exit at point C and half of them to exit at point F.

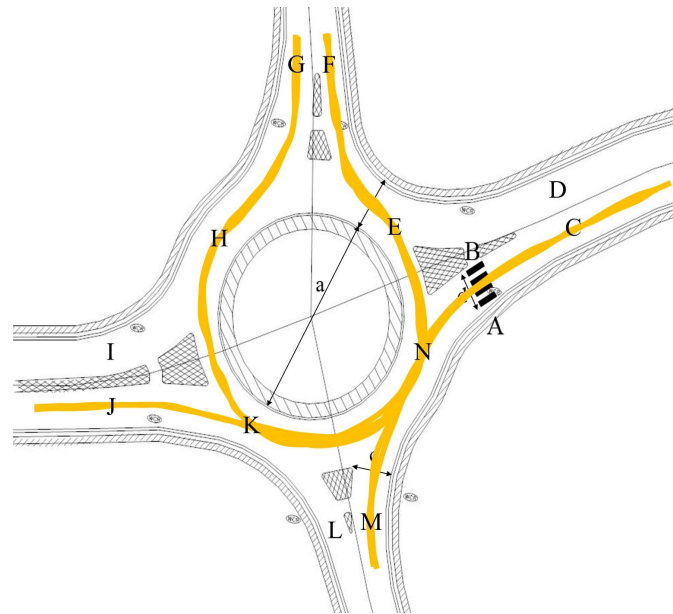

Figure V.5: The architectural model of the roundabout, showing the pedestrians crossing area and vehicle travel paths.

The system creates the traffic stream so that there is a gap between vehicles, such that a pedestrian at A or B might choose to cross. This gap is the target gap. Each traffic stream is scheduled based on a specified time gap between every two adjacent vehicles. Most of these time gaps represent non-target intervals, which are set to less than 1.5 seconds. Only one randomly selected gap in the stream is set to the target gap value, which can range between a minimum of 2 seconds and a maximum of 10 seconds. We were interested in analyzing street-crossing decisions made at this interval, which simulated a safe crossing interval.

As in our previous study (Wu et al., 2009), we applied a maximum-likelihood stimulus procedure (MLP) (Grassi and Soranzo, 2009) as an evaluation methodology to obtain the minimal threshold of gap selection. Each pedestrian crossed the street 20 times, either

from point A to B or from point B to A, as seen in Figure V.5. Each time a participant either crossed the street in a target gap, or in a non-target gap. Based on the specified target gap duration and the pedestrians crossing outcome, MLP found a minimal gap duration indicating that this participant chose to cross the street 75% of the time.

Participants were instructed to find a safe and comfortable gap in traffic to cross the street, without running and without missing opportunities to cross, just as they would in the real world. Participants were instructed to wait until the first car passed before attempting to cross. In addition, participants were asked to assume that vehicles would not yield in response to their crossing. We desired participants to assume responsibility for their safety, even though the virtual vehicles would yield to pedestrians in practice. Participants were encouraged to finish each crossing after initiating one, even if they believed that their decision was unsafe. Based in pilot testing, each participant completed 20 trial crossings, which was enough to insure convergence of the maximum likelihood procedure.

The outcome in a trial was deemed a “go” if the pedestrian started crossing during the target gap for a given stream of traffic. A “no-go” outcome occurred if the target gap passed without the pedestrian initiating a cross. Under “go” conditions, a safe crossing indicates the participant successfully crossed before the target gap passed, otherwise, the crossing was classified as unsafe. An invalid outcome occurred if the pedestrian started crossing during a gap preceding the target gap, in which case that crossing was invalidated and repeated in later trials.

For all go outcomes, the system recorded the time points when a pedestrian started crossing and finished crossing the street. With this system, we recorded two other dependent variables, in addition to the gap threshold. One dependent variable was the curb delay, which was the time elapsed from the beginning of the target gap to the start of crossing behavior, representing how long the pedestrian delayed on the curb before actually initiating their crossing. The other dependent variable was the crossing time, which was the elapsed time between the start of a crossing and the completion of that crossing. More details of the

general design of street crossing are in Wu et al. (2009).

Hypotheses

The independent variable for this experiment was scotoma size, which generated three visual conditions: normal vision (zero scotoma), which provided base line results; 10° of visual angle of absolute scotoma with 20° of visual angle of relative scotoma; and 20° of visual angle of absolute scotoma with 40° of visual angle of relative scotoma. Each participant was randomly assigned to one of these three viewing conditions.

Our size decision on scotoma was based on the research of Sunness et al. (2007), who showed a progression of increasing scotoma size at different stages of macular degeneration, from less than 10° of visual angle near the onset of the disease, to up to 20° of visual angle for late stage. We selected a small and large size of absolute scotoma and doubled the size of relative scotoma to compare the effect.

In pilot studies conducted with full screen visual acuity variations, we found that varying acuity alone did not change gap estimation performance significantly, possibly because it is easy to estimate moving blobs in a static background. This finding held, even at severe degradations in acuity of 20/1,000. We did not, therefore, plan to vary the acuity in this study, but set the relative scotoma at a fixed value of 20/500 for the simulated conditions.

By simulating a controllable scotoma coupled with low visual acuity, we were able to simulate the main characteristics foveal vision loss characteristic of macular degeneration. We hypothesized that simulated macular degeneration would cause participants to select a longer target gap to cross, experience a longer curb delay, and experience a longer gap crossing time in comparison to participants who do not experience the simulated impairment. There is some suggestion in the literature (e.g., Simpson et al. (2003); Holland and Hill (2007)) of males making riskier road crossing decisions than females, and we hypothesized that this will be the case regardless of visual condition.

Participants

A pilot study revealed that some participants experienced difficulties with the eye-tracking solution. While most participants could be calibrated in approximately ten minutes, some could not be calibrated accurately at all with the eye-tracker, due to imperfect fit of the HMD and eye-tracker on the head. Therefore, we conducted pre-screening sessions prior to the experiment to train participants to use the eye-tracking HMD. If a participant's pupil still evaded detection by the eye-tracker, then they were eliminated from the experiment.

We recruited 41 participants in total. Three participants were excluded, because of inability to calibrate the eye-tracker. Another two participants were excluded due to motion sickness during the experiment. Our final results are derived from the remaining 36 participants. The participant group included 18 males and 18 females ranged in age from 18 to 31 years old. All participants were normally sighted without eyeglasses, although participants who were corrected to normal with contact lenses were allowed.

Participants were randomly assigned to one of the visual conditions of no simulated scotoma, a 10° of visual angle of absolute scotoma with 20° of visual angle of relative scotoma (10/20), or a 20° of visual angle of absolute scotoma with 40° of visual angle of relative scotoma (20/40). A between groups design was chosen to minimize overall time in the HMD and to avoid the possibility of carry-over effects from one condition to another.

Apparatus

The experiment was conducted in a 29 x 23 ft. room. We used the Vizard (Worldviz, Santa Barbara, CA) platform to develop the virtual roundabout environment. Our system includes a WorldViz rendering computer, Precision Position Tracker server with 4 cameras, an audio rendering computer with a pair of Klipsch S4 earbuds. The HMD and eye tracker were described previously in Section V.

An InterSense IS-900 precision motion tracker is used to update the participants rotational movements with six degrees of freedom. Position is updated using 4 optical tracking

cameras working in coordination with 2 LED lights at 60Hz. For the ViewPoint EyeTracker, the expected difference in degrees of visual angle between true eye position and mean computed eye position is approximately 0.25° to 1.0° visual arc. The smallest change in eye position that can be measured is approximately 0.15° visual arc.

As mentioned previously, in order to preserve proper calibration and prevent slipping of the HMD, we required participants to don a silicone-swimming cap before using the HMD and we required participants to wear a belt to secure the HMD's tethered cable. In addition, throughout the experiment a helper, carrying a backpack which held the HMD machine, followed the participants to ensure that the cable would not be pulled or pushed.

Procedure

Participants started by completing a written consent form and questionnaire asking about prior experience with video games and virtual reality. In particular, participants were assured that they could take a break or quit at any point, if they desired or if they began to feel sick. Next, participants were shown a Google map depiction of the real world roundabout from which the virtual model was derived. The direction of traffic flow was depicted. The experimental task (safe road crossing in the face of traffic) was explained to the participant and they were informed that their vision would be obstructed if they were in one of the visual impairment conditions. Participants were told that they would be crossing the street 20 times with traffic over the course of the experiment. Participants donned ear buds, swim cap, HMD, and belt. The eye cameras were calibrated in a process taking between five and ten minutes. The HMD was adjusted to be secure before calibration and participants were asked to not touch the HMD, unless they wanted to take a break or quit the experiment, as the calibration procedure would need to be repeated. Participants were introduced to the virtual environment with full vision and crossed the street once without traffic to introduce them to locomotion in the HMD. After each street crossing, a quick recalibration of the eyetracker, as described in Section V was performed. At this point, participants were introduced to their

specific visual condition. Participants were asked to inform the experimenter if the central scotoma was not in line with their gaze, at which time another recalibration was performed. The traffic simulation was started, and the participant began to cross the street in traffic. After 20 crossings, participants were compensated for their time.

Results

Figure V.6 shows the overall gap crossing distributions, grouped by vision condition and gender, for the 36 participants in their 20 crossings. This diagram illustrates the various conditions defined in Section V for the gaps in traffic: “go and safe” represents the percentage of trials, where participants selected a target gap and crossed the street safely; “go but unsafe” represents the percentage of trials in which participants selected an unsafe gap to cross the street; and “no-go” represents the percentage of trials in which participants elected to not cross the street during the presented traffic stream.

The first row of Figure V.6 displays the data decomposed by vision condition. Qualitatively, the result demonstrates that a larger size of simulated scotoma results in a lower percentage of safe crossings. In particular, there is a decrease in the percentage of go and safe crossings, which drops from 25% to 18% between the no scotoma and the 20°/40° scotoma conditions. This result is consistent with the hypothesis that participants with simulated macular degeneration will have fewer safe crossings. In addition, the percentage of no-go trials increased from 45% to 55%, indicating that participants with larger sizes of simulated scotomas missed more opportunities to cross the street. However, the percentage of unsafe crossings did not increase. These results suggest that participants became more conservative with their risk taking behavior as the size of scotoma increased. In the second row of the figure, which displays the data as grouped by gender, we observe that male participants had fewer “no-go” trials and that they perform fewer safe crossings, indicating that male participants have a greater propensity for risk taking than their female counterparts.

There are two between-subjects independent variables: gender (two levels: male, female)

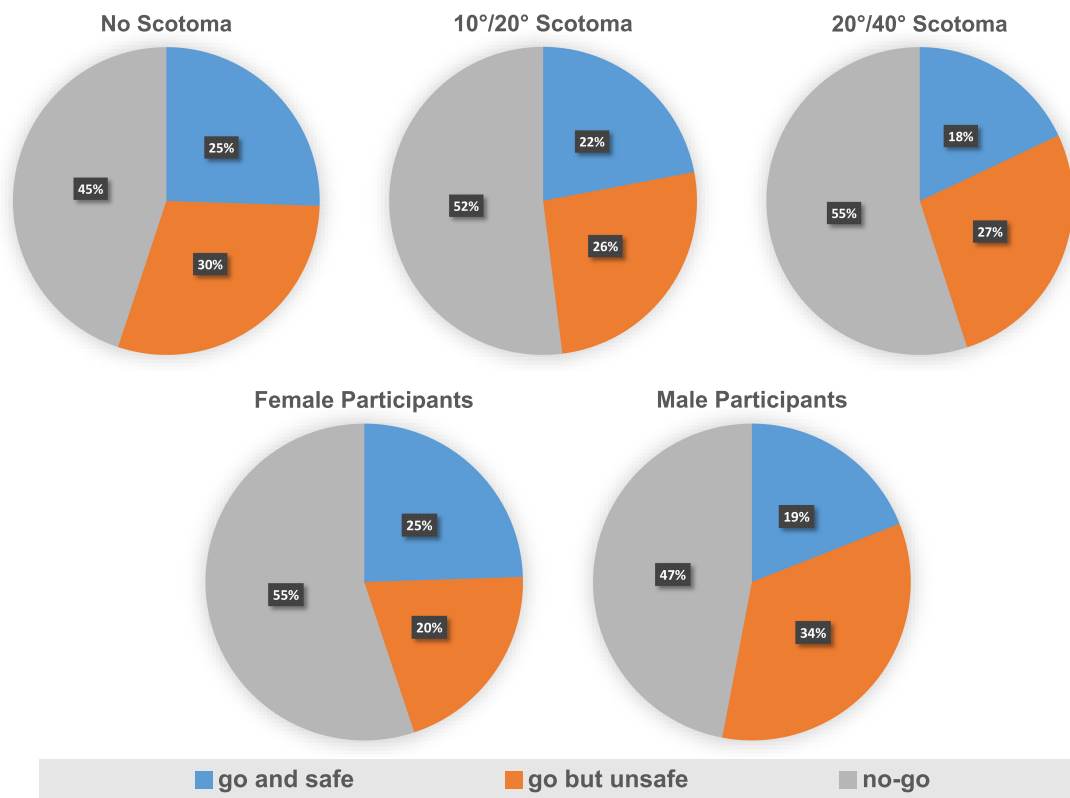

Figure V.6: Crossing distribution by group and crossing distribution by gender in experiment.

and vision condition (three levels: no scotoma, 10°/20° of absolute/relative scotoma, 20°/40° of absolute/relative scotoma). Table V.1 lists the complete breakdown of mean and standard error values for these three dependent variables: gap threshold (the discrimination threshold of crossing gaps), curb delay (the time elapsed from the beginning of the designated gap to the start of actual street crossing), and crossing time (the time elapsed from the start of street crossing to the finish of street crossing). The no scotoma participants had the smallest gap threshold (4.204 seconds) with smallest curb delay (1.661 seconds); and participants with 20°/40° of absolute/relative scotoma had largest gap threshold (6.177 seconds) with largest curb delay (2.639 seconds).

Table V.1: Key measures in seconds under different scotoma conditions.

Condition	Gap Threshold		Curb Delay		Crossing Time	
	<i>Mean</i>	<i>SE</i>	<i>Mean</i>	<i>SE</i>	<i>Mean</i>	<i>SE</i>
No Scotoma	4.204	0.363	1.661	0.143	3.267	0.109
<i>Male</i>	3.741	0.279	1.424	0.073	3.283	0.144
<i>Female</i>	4.667	0.644	1.897	0.250	3.251	0.176
10°/20°	5.660	0.510	2.224	0.202	3.933	0.258
<i>Male</i>	4.612	0.648	1.933	0.227	3.936	0.497
<i>Female</i>	6.707	0.536	2.515	0.306	3.929	0.211
20°/40°	6.177	0.511	2.639	0.270	3.907	0.189
<i>Male</i>	5.864	0.769	2.357	0.414	3.924	0.196
<i>Female</i>	6.490	0.719	2.922	0.344	3.889	0.346

Figure V.7 shows the mean gap thresholds, mean curb delays, and mean crossing times broken out by both vision condition and gender. We analyzed our results using a two-way

between-subjects analysis of variance (ANOVA). For the gap threshold, there are main effects of vision condition, $F(2, 30) = 5.4415$, $p = 0.0096$, and of gender, $F(1, 30) = 5.7624$, $p = 0.023$. A post-hoc Tukey test showed that the no scotoma, $10^\circ/20^\circ$ scotoma, and $20^\circ/40^\circ$ scotoma all differed significantly. Also males had significantly shorter gap thresholds than females. Likewise, for curb delay, the ANOVA found main effects of both vision condition, $F(2, 30) = 5.6694$, $p = 0.0082$, and gender, $F(1, 30) = 5.1099$, $p = 0.031$. A post-hoc Tukey test showed that the no scotoma condition had a significantly shorter curb delay than the $20^\circ/40^\circ$ scotoma condition; the $10^\circ/20^\circ$ scotoma condition was not significantly different from either, but lay somewhere in the middle. Crossing time was not statistically different between groups.

There is a linear correlation between these dependent variables. Pearson's coefficient of correlation between gap threshold and curb delay is 0.888 ($t = 11.259$, $df = 34$, $p < 0.001$). Likewise, the Pearson's coefficient of correlation between gap threshold and crossing time is 0.533 ($t = 3.6763$, $df = 34$, $p < 0.001$); and the coefficient of correlation between curb delay and crossing time is 0.595 ($t = 4.3208$, $df = 34$, $p < 0.001$). Thus, high gap threshold tends to be paired with relatively high curb delay and high crossing time.

In summary, we found statistically significant differences between the vision conditions. A larger size scotoma resulted in a longer gap threshold, and a longer curb delay. However, the most dramatic differences were typically found between the presence and the absence of a scotoma. These findings are consistent with our hypotheses that participants with simulated macular degeneration will select a longer gap to cross and experience a longer curb delay. We also found gender differences in some measures. Male participants tended to take more risk, which was demonstrated by the selection of shorter gaps and shorter waiting times prior to crossing. This finding is consistent with our second hypothesis. However, the males in our sample group were also more familiar with video games, as self-reported in their responses to our questionnaire, with 10 of 18 participants reporting regularly playing video games an average of 7 hours per week ($SD=5.2$ hours); in contrast, only one of 18 females

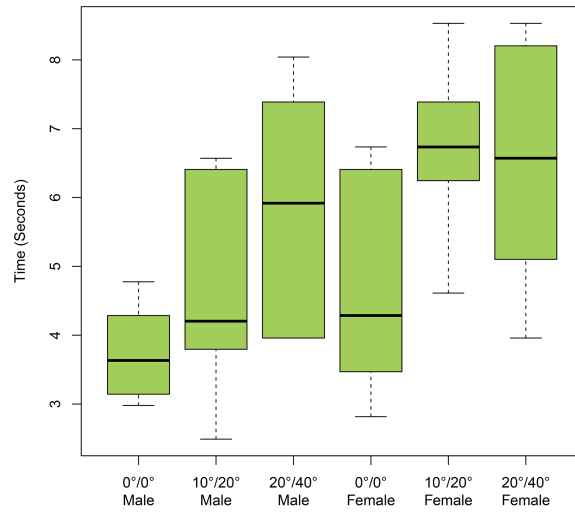

(a) Gap threshold

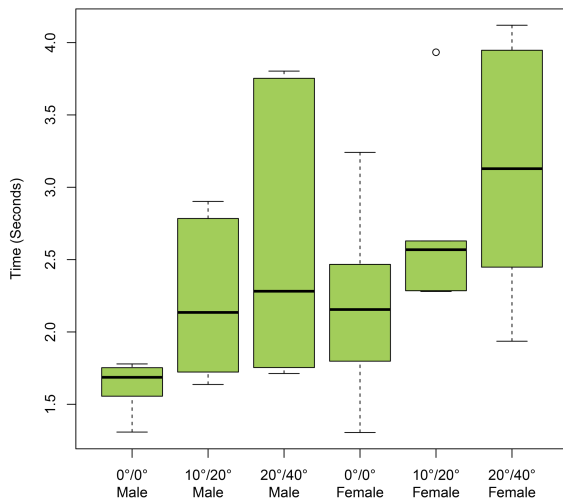

(b) Curb delay

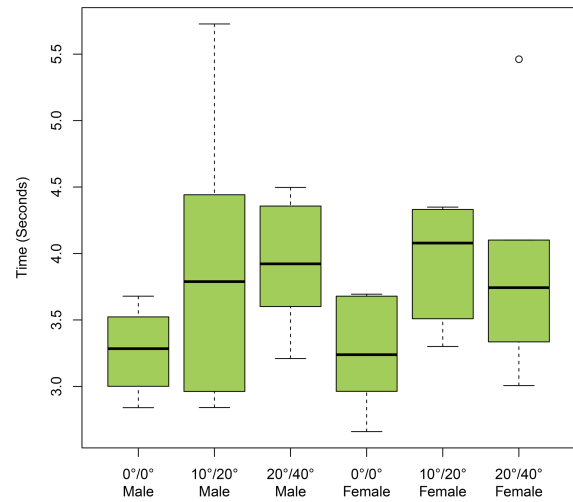

(c) Crossing time

Figure V.7: Medians and quartiles of the various measures broken out by vision condition and gender.

reported playing video games regularly, an average of 7 hours per week. It is possible that increased familiarity with the virtual environment leads to increased risk-taking, although Spearman's rank-order correlation did not identify significance.

Discussion

We simulated central visual field loss and assessed the affect of this loss on normally sighted individuals making road crossing decisions at a roundabout. We found support for our hypothesis that this loss would increase the gap threshold and result in increased curb delay, but did not find a statistically significant difference in crossing times for participants once they had selected a gap to cross. Compared to no scotoma, each level of increased scotoma size that we implemented resulted in a longer gap threshold selection, but our only significant difference in the curb delay was between the no scotoma and the largest scotoma size (20°/40°). Regarding crossing times, it may be that once participants decide to cross the street, their walking pace is not strongly subject to visual feedback and, thus, visual field impairment may result in only incidental increases. We also found support for our hypothesis that there would be gender differences in the data. Male participants tended to take more risk, which was demonstrated by the selection of shorter gaps and shorter waiting times prior to crossing. This gender difference was not due to faster crossing times by males, since both genders crossed in about 3.9 seconds on average.

Hassan et al. (2002) studied macular degeneration patients and found that mobility performance, such as walking speed, decreased as the size of a binocular central scotoma increased. In our study, normal-sighted participants exposed to central vision loss selected a longer gap threshold with increasing scotoma size. Our gap thresholds and crossing times are in accord with those of our prior work (Wu et al., 2009). O'Neal et al. (2017) used a linear intersection and large screen immersive display environment and found gap thresholds generally consistent with ours, but crossing times that were faster, possibly an artifact in our work of participants wearing an HMD. It is potentially interesting to note that

the large screen immersive display environment involved a wide, naturalistic field of view in a linear intersection, and ours involved a restricted field of view in a roundabout, and yet the gaps chosen in the large screen immersive display environment by adult population (approximately 4.45s) and our no scotoma adult population (4.2s) were close. It is always important to examine field of view as an ecological factor in assessing simulation validity when using HMDs, and the NVIS SX60 has limited field of view compared to commodity level devices available today, but it may not be an important factor in this area of investigation. Our work showing that males make riskier choices is consistent with a large body of literature that indicates male gender as a risk factor in pedestrian injury, e.g., Schiff and Oldak (1990); Assailly (1997); Rosenbloom et al. (2004); Barton and Schwebel (2007).

Our simulation allowed us to explore the effect of central vision loss on these gap thresholds. The simulation is configurable to allow a variety of visual impairments to be implemented. We chose extreme central vision loss as a test case, since with moderate blur locomotion and road crossing seem to be unaffected (although such things as reading would be severely affected), as evidenced by Figure V.4. Future work will model foveal deficits and maculopathies in more detail, with the goal of examining mechanisms of disease progression through behavior. Some limitations in the present simulation that may hinder this work are that it is difficult to characterize the accuracy of eye-tracking given the two-step calibration procedure used and the slippage of the HMD on the head. Our assessment criterion in this study was behavioral, and did not require more accurate assessment of the eye tracking system's limits, c.f., Geringswald et al. (2013), but that may not be true of future work.

Our simulation incorporated spatialized audio as a component of the experience. It was not tested as a factor in any of these experiments, but sound is known to be a cue for making crossing decisions in the real world. Geruschat et al. (2011) found that pedestrians with full sight were more sensitive when their hearing was occluded, whereas in the low vision groups hearing occlusion did not affect sensitivity. Hassan (2012) was also noted that the visually impaired participants' traffic gap detection performance was unaffected by hearing

occlusion. There is significant interest in how audio cues are used by the visually impaired, particularly with the increase of quieter hybrid and electric vehicles on the street (Emerson et al., 2011), and such investigation is a topic of future research.

The use of virtual reality was critical. Virtual reality provides an environment in which a dangerous scenario — traffic crossing with visual impairment — can be investigated in a controlled and rigorous manner. Testing participants with true visual impairment in true traffic situations is difficult, and some form of proxy is often used. For example, Geruschat et al. (2011) used participants with actual macular degeneration or peripheral vision loss at a live intersection with real traffic, but had them press triggers to indicate when they would cross, rather than actually cross. Our results are, nonetheless consistent with theirs, with ours having considerably easier recruitment, ease of execution, no real danger, and containing actual locomotion, which suggests that our traffic crossing scenario allows us to design and conduct effective research in perception and action in dynamic situations. The simulation of visual impairment for normally sighted individuals can provide an important educational tool to investigate a significant social problem. The result of this research could deliver important insight in how to improve structures for the safety of those with visual impairments. In particular, the first-person experience provided by our simulation could provide important insights for safe design in engineering intersections and more.

CHAPTER VI

Conclusion

This dissertation has explored the question of what is necessary to build a high performance, high-fidelity immersive virtual environment that can be used to conduct controlled scientific investigation of a phenomenon that is difficult to study in the real world. The scenario we investigated was that of traffic crossing behavior of individuals in a complex traffic intersection, a roundabout. We studied how pedestrians made choices to select patterns in traffic on when to cross the street. We called our IVE high-fidelity because we consistently found that our results were generally consistent with similar studies done in the real world, although we did not conduct a direct comparison ourselves. We call our IVE high performance because it was implemented on commercially available hardware without anything being custom built.

This dissertation makes several novel contributions. This dissertation was the first to present a complex, to-scale model of a real roundabout with a compelling traffic simulation to assess pedestrian road-crossing behavior. This simulation included both spatialized sound and circulating traffic. This dissertation was also the first to develop a visual deficit simulation and apply that to road crossing behavior. We assessed all of these developments through controlled studies. The findings of these studies were generally consistent with what had been found in prior work, e.g., that males engage in more risk-taking behavior in crossing traffic. One novel finding was that circulating traffic in a roundabout leads to less safe pedestrian street crossing behavior. More in-depth research is needed to validate this finding, but it could have implications for the placement of crosswalks at exit lanes.

In our first study, normally sighted pedestrians chose a reasonable gap in oncoming traffic to initiate a successful crossing. We found the average gap of 4.08 seconds [SE=0.11] for successful crossings, and the average gap of 4.37 seconds [SE=0.29] for successful and also safe crossings. Considering that pedestrians are more likely to be conservative in a real

physical environment with real vehicles, our underestimated crossing gap in 4.08 seconds agrees well with 6 seconds finding of Ashmead et al. (2005) for normally sighted individuals crossing a road of similar intersection. As we discussed in Chapter II, there are several potential reasons for this difference relating to the fidelity of the IVE. It is possible, for instance, that the limited field of view of the HMD caused the difference.

The complexity of circulating traffic in roundabout makes the crossing behavior at an exit lane even more difficult to investigate in a real physical roundabout. Our traffic simulation has the ability to generate traffic with a defined ratio of vehicles that continue circulating, versus exiting to the exit lane, which provides the opportunity to study the effect of different traffic pattern that would be difficult to approximate in real-world. Our results showed that high rates of circulating traffic lead to pedestrians making a smaller gap judgment, which indicated more unsafe crossings with an increase in circulating traffic. To our knowledge, this is the first simulation to incorporate these traffic details and assess crossing behavior for these scenarios.

It is unclear why people became less cautious with the increase in circulating traffic, but, similar factors as before may be at play. The fidelity of the simulation may be less when the complexity of the scenario involved in perception and action judgments increases. This idea, that the fidelity is related to scenario complexity, has not been carefully explored by the community and would be a good topic for further study. However, we should not discount how pedestrians likely make crossing decisions. Their crossing judgment may be based simply on whether the vehicle at the turning point circulates or exits, and they begin crossing once they see a vehicle circulate, without regard for any vehicles behind it. Thus, the complexity of the roundabout may make their perception and decision process less accurate.

The restriction of the horizontal field of view in HMDs would seem to be a major limiting factor of this work, when compared to the real world. It leads to the limited ability of participants to see as much of the entering lanes of traffic as they would if the field of view

were closer to their natural one. Also at the moment of initializing a crossing, a wider field of view might allow pedestrians to glance at the oncoming vehicle and provide an instant visual feedback in terms of whether the crossing would be successful or not. It would be interesting to repeat these experiments with the wider field of view HMDs that are currently available on the market.

To improve user experience in the traffic IVE, we added 3D spatialized traffic sounds and evaluated them in gap crossing experiments. We found spatially rendered sound is helpful in gap perception in a roundabout, just like real sound in the real world. We also note that users like having the spatialize sound in the IVE. Although the particular application was applied to pedestrian crossing of a roundabout, the distributed real-time architecture can be used in the context of any HMD-based IVE.

An eye-tracker based visual deficits simulation demonstrated our ability to simulate central vision deficits on normally sighted people. With this simulation, we can control of characteristics of macular degeneration, and the experimental results showed findings consistent with previous studies that a larger size of the absolute scotoma results in poor performance in terms of street crossing tasks. This system has the ability to simulate a variety of visual impairments. The system is unique in that it represents a first attempt to evaluate both visual and auditory cues and investigate how they affect each other in the perception of gaps in traffic. In future work, it would be interesting to see, for example, how auditory cues are used by different types of visually impaired individuals, which suggests that our system supplies an important educational tool for vulnerable population.

There are many other avenues for future work. On the virtual reality side, avenues include improving the quality of the IVE and expanding the scope of the simulation. For example, replacing the non-individual HRTF with an individual HRTF and assessing the quality of the improved simulation. Indeed, improving the overall quality of the virtual environment soundscape has been a topic of considerable interest in the field (Mehra et al., 2015), and it may be that improved sound models, in addition to HRTFs would improve

participants' ability to localize sound. It should be noted, for example, that our current sound model does not incorporate such fundamental effects as Doppler shifting. Although the speeds through the roundabout are low, a relatively simple calculation shows that frequency shifts of around 3% could be expected due to Doppler effects in the roundabout and that is likely detectable and may have an impact on the ability to localize.

On the applications side, there are many other studies that could be done to assess pedestrian crossing behavior in a roundabout, and the simulation could be employed to study that question in significantly greater detail. For example, it is known that children do not cross traffic at linear intersections as well as adults (O'Neal et al., 2018). Given that roundabouts are now being constructed in neighborhoods to slow traffic down, investigating how children behave in more complex traffic intersections would be interesting. Pedestrian behavior outside of the posted crosswalks could also be assessed, as little is known about that in the published literature.

In summary, the integration of traffic simulation, acoustic simulation, and vision deficit simulation in an immersive virtual environment provides an engaging platform, with which we could assess how competent virtual reality is in transportation and vision research. By studying gap perception for pedestrians in a roundabout environment, we are searching for insights into how to engineer the safe design of roundabouts for pedestrians from both a general population and those with visual impairments.

BIBLIOGRAPHY

- Ai, Z., Gupta, B. K., Rasmussen, M., Lin, Y. J., Dech, F., Panko, W., and Silverstein, J. C. (2000). Simulation of eye diseases in a virtual environment. In *Proceedings of the 33rd Annual Hawaii International Conference on System Sciences*, page 5. IEEE Computer Society.
- Arradondo, B. and Kirkpatrick, M. (2019). Nashville turns to roundabouts to curb speeding, traffic congestion. https://www.wsmv.com/news/nashville-turns-to-roundabouts-to-curb-speeding-traffic-congestion/article_db9ec5af-5265-5322-aac1-9f2e253b3c68.html.
- Ashmead, D. H., Guth, D., Wall, R. S., Long, R. G., and Ponchillia, P. E. (2005). Street crossing by sighted and blind pedestrians at a modern roundabout. *Journal of Transportation Engineering*, 131(11):812–821.
- Ashmead, D. H., Leroy, D., and Odom, R. D. (1990). Perception of the relative distances of nearby sound sources. *Perception & Psychophysics*, 47(4):326–331.
- Assailly, J. (1997). Characterization and prevention of child pedestrian accidents: An overview. *Journal of Applied Developmental Psychology*, 18(2):257 – 262.
- Astheimer, P. (1993). What you see is what you hear-acoustics applied in virtual worlds. In *Proceedings of 1993 IEEE Research Properties in Virtual Reality Symposium*, pages 100–107.
- Ates, H. C., Fiannaca, A., and Folmer, E. (2015). Immersive simulation of visual impairments using a wearable see-through display. In *Proceedings of the Ninth International Conference on Tangible, Embedded, and Embodied Interaction*, pages 225–228. ACM.
- Baldan, S., Lachambre, H., Monache, S. D., and Boussard, P. (2015). Physically informed car engine sound synthesis for virtual and augmented environments. In *2015 IEEE 2nd VR Workshop on Sonic Interactions for Virtual Environments (SIVE)*, pages 1–6.
- Banks, D. and McCrindle, R. J. (2008). *Visual Eye Disease Simulator*.
- Barton, B. K. and Schwebel, D. C. (2007). The roles of age, gender, inhibitory control, and parental supervision in children’s pedestrian safety. *Journal of Pediatric Psychology*, 32(5):517–526.
- Begault, D. R. (1994). *3-D Sound for Virtual Reality and Multimedia*. Academic Press Professional, Inc., San Diego, CA, USA.
- Belloch, J. A., Ferrer, M., Gonzalez, A., Martinez-Zaldivar, F., and Vidal, A. M. (2013). Headphone-based virtual spatialization of sound with a gpu accelerator. *J. Audio Eng. Soc.*, 61(7/8):546–561.

- Bernhard, M., Grosse, K., and Wimmer, M. (2008). Bimodal task-facilitation in a virtual traffic scenario through spatialized sound rendering. *ACM Trans. Appl. Percept.*, 8(4):24:1–24:22.
- Board, T. R., National Academies of Sciences, E., and Medicine (2007). *Roundabouts in the United States*. The National Academies Press, Washington, DC.
- Bormann, K. (2005). Presence and the utility of audio spatialization. *Presence: Teleoper. Virtual Environ.*, 14(3):278–297.
- Bormann, K. (2006). Subjective performance. *Virtual Reality*, 9(4):226–233.
- Burkhard, M. D. and Sachs, R. M. (1975). Anthropometric manikin for acoustic research. *The Journal of the Acoustical Society of America*, 58(1):214–222.
- Cheong, A., Geruschat, D., and Congdon, N. (2008). Traffic gap judgment in people with significant peripheral field loss. *Optometry and vision science : official publication of the American Academy of Optometry*, 85:26–36.
- Cheung, S. and Legge, G. (2005). Functional and cortical adaptations to central vision loss. *Visual Neuroscience*, 22:187–201.
- Chihak, B., Plumert, J., Ziemer, C., Babu, S., Grechkin, T., Cremer, J., and Kearney, J. (2014). Synchronizing self and object movement: How child and adult cyclists intercept moving gaps in a virtual environment. *Journal of experimental child psychology*, 122:134–152.
- Clancy, T. A., Rucklidge, J. J., and Owen, D. H. (2006). Road-crossing safety in virtual reality: A comparison of adolescents with and without adhd. *Journal of Clinical Child and Adolescent Psychology*, 35(2):203–215.
- Connelly, M. L., Conaglen, H. M., Parsonson, B. S., and Isler, R. B. (1998). Child pedestrians' crossing gap thresholds. *Accident Analysis & Prevention*, 30(4):443 – 453.
- Cornelissen, F. W., Bruin, K. J., and Kooijman, A. C. (2005). The influence of artificial scotomas on eye movements during visual search. *Optometry & Vision Science*, 82(1):27–35.
- Daniels, S., Brijs, T., Nuyts, E., and Wets, G. (2010). Externality of risk and crash severity at roundabouts. *Accident Analysis & Prevention*, 42(6):1966 – 1973.
- Doerr, K., Rademacher, H., Huesgen, S., and Kubbat, W. (2007). Evaluation of a low-cost 3d sound system for immersive virtual reality training systems. *IEEE Transactions on Visualization and Computer Graphics*, 13(2):204–212.
- Dommes, A. and Cavallo, V. (2011). The role of perceptual, cognitive, and motor abilities in street-crossing decisions of young and older pedestrians. *Ophthalmic and Physiological Optics*, 31(3):292–301.

- Dong, M., Wang, H., and Guo, R. (2017). Towards understanding the differences of using 3d auditory feedback in virtual environments between people with and without visual impairments. In *2017 IEEE 3rd VR Workshop on Sonic Interactions for Virtual Environments (SIVE)*, pages 1–5.
- Emerson, R. W., Naghshineh, K., Hapeman, J., and Wiener, W. (2011). A pilot study of pedestrians with visual impairments detecting traffic gaps and surges containing hybrid vehicles. *Transportation Research Part F: Traffic Psychology and Behaviour*, 14(2):117 – 127.
- Ergun, E., Maar, N., Radner, W., Barbazetto, I., Schmidt-Erfurth, U., and Stur, M. (2003). Scotoma size and reading speed in patients with subfoveal occult choroidal neovascularization in age-related macular degeneration. *Ophthalmology*, 110(1):6569.
- Gardner, W. G. and Martin, K. D. (1995). Hrtf measurements of a kemar. *The Journal of the Acoustical Society of America*, 97(6):3907–3908.
- Geringswald, F., Baumgartner, F., and Pollmann, S. (2012). Simulated loss of foveal vision eliminates visual search advantage in repeated displays. *Frontiers in human neuroscience*, 6.
- Geringswald, F., Baumgartner, F. J., and Pollmann, S. (2013). A behavioral task for the validation of a gaze-contingent simulated scotoma. *Behavior Research Methods*, 45(4):1313–1321.
- Geronazzo, M., Bedin, A., Brayda, L., Campus, C., and Avanzini, F. (2016). Interactive spatial sonification for non-visual exploration of virtual maps. *International Journal of Human-Computer Studies*, 85:4 – 15. Data Sonification and Sound Design in Interactive Systems.
- Geronazzo, M., Carraro, A., and Avanzini, F. (2015). Evaluating vertical localization performance of 3d sound rendering models with a perceptual metric. In *2015 IEEE 2nd VR Workshop on Sonic Interactions for Virtual Environments (SIVE)*, pages 1–5.
- Geruschat, D., Fujiwara, K., and Wall Emerson, R. (2011). Traffic gap detection for pedestrians with low vision. *Optometry and Vision Science*, 88(2):208–216.
- Geruschat, D., Fujiwara, K., and Wall-Emerson, R. S. (2006). Gaze behavior of the visually impaired during street crossing. *Optometry and Vision Science*, 83(8):550–558.
- Gibson, J. J. (1979). *The ecological approach to visual perception*. Houghton Mifflin, Boston, MA.
- Grassi, M. and Soranzo, A. (2009). Mlp: a matlab toolbox for rapid and reliable auditory threshold estimation. *Behavior Research Methods*, 41(1):21–28.
- Grechkin, T. Y., Chihak, B. J., Cremer, J. F., Kearney, J. K., and Plumert, J. M. (2013). Perceiving and acting on complex affordances: How children and adults bicycle across two lanes of opposing traffic. *Journal of Experimental Psychology*, 29(1):2336.

- Green, D. M. and Swets, J. A. (1966). *Signal Detection Theory and Psychophysics*. John Wiley and Sons, New York.
- Guez, J., Le Gargasson, J., Rigaudiere, F., and O'Regan, J. (1993). Is there a systematic location for the pseudo-fovea in patients with central scotoma? *Vision Research*, 33:1271-1279.
- Guth, D., Ashmead, D., Long, R., Wall, R., and Ponchillia, P. (2005). Blind and sighted pedestrians' judgments of gaps in traffic at roundabouts. *Human Factors: The Journal of the Human Factors and Ergonomics Society*, 47(2):314-331.
- Guth, D. A., Long, R. G., Emerson, R. S. W., Ponchillia, P. E., and Ashmead, D. H. (2013). Blind and sighted pedestrians road-crossing judgments at a single-lane roundabout. *Human Factors*, 55(3):632-642. PMID: 23829036.
- Hassan, S. (2012). Are normally sighted, visually impaired, and blind pedestrians accurate and reliable at making street crossing decisions? *Investigative Ophthalmology and Visual Science*, 53:2593-2600.
- Hassan, S., Lovie-kitchin, J., and Woods, R. (2002). Vision and mobility performance of subjects with age-related macular degeneration. *Optometry and Vision Science*, 79(11):697-707.
- Hassan, S. and Snyder, B. (2012). Street-crossing decision-making: A comparison between patients with age-related macular degeneration and normal vision. *Investigative Ophthalmology and Visual Science*, 53:6137-6144.
- Hiipakka, M., Kinnari, T., and Pulkki, V. (2012). Estimating head-related transfer functions of human subjects from pressure-velocity measurements. *The Journal of the Acoustical Society of America*, 131(5):4051-4061.
- Holland, C. and Hill, R. (2007). The effect of age, gender and driver status on pedestrians intentions to cross the road in risky situations. *Accident Analysis & Prevention*, 39(2):224 - 237.
- Inman, V. W., Davis, G. W., and Sauerburger, D. (2006). Pedestrian access to roundabouts: Assessment of motorists' yielding to visually impaired pedestrians and potential treatments to improve access. Technical Report FHWA-HRT-05-080, Federal Highway Administration.
- Jacquemart, G. (1998). Modern roundabout practice in the united states. Technical report, National Cooperative Highway Research Program.
- Jiang, Y., O'Neal, E., Rahimian, P., Yon, J. P., Plumert, J. M., and Kearney, J. K. (2016). Action coordination with agents: Crossing roads with a computer-generated character in a virtual environment. In *Proceedings of the ACM Symposium on Applied Perception, SAP '16*, pages 57-64, New York, NY, USA. ACM.

- Jiang, Y., O'neal, E. E., Yon, J. P., Franzen, L., Rahimian, P., Plumert, J. M., and Kearney, J. K. (2018). Acting together: Joint pedestrian road crossing in an immersive virtual environment. *ACM Trans. Appl. Percept.*, 15(2):8:1–8:13.
- Jin, B., Ai, Z., and Rasmussen, M. (2005). Simulation of eye disease in virtual reality. In *Proceedings of the 27th Annual International Conference of the IEEE Engineering in Medicine and Biology Society*, pages 5128–5131. IEEE Computer Society.
- K. Kearney, J., Grechkin, T., Cremer, J., and Plamert, J. (2006). Traffic generation for studies of gap acceptance. *Driving Simulation Conference*.
- Kapralos, B., Jenkin, M. R., and Milios, E. (2008). Virtual audio systems. *Presence: Teleoperators and Virtual Environments*, 17(6):529–549.
- Kemeny, A. and Panerai, F. (2003). Evaluating perception in driving simulation experiments. *Trends in Cognitive Sciences*, 7:31–37.
- Kolarik, A., Cirstea, S., and Pardhan, S. (2013). Discrimination of virtual auditory distance using level and direct-to-reverberant ratio cues. *The Journal of the Acoustical Society of America*, 134(5):3395–3398.
- Lacouture-Parodi, Y. and Habets, E. A. P. (2012). Crosstalk cancellation system using a head tracker based on interaural time differences. In *IWAENC 2012; International Workshop on Acoustic Signal Enhancement*, pages 1–4.
- Layden, M. (2019). More traffic circles replacing 4-way stops in nashville. <https://www.wsmv.com/news/more-traffic-circles-replacing-way-stops-in-nashville/article.60c6587e-4bfd-11e9-a51a-d3970e17d1f8.html>.
- Lee, A. T. (2006). Flight simulation: Virtual environment in aviation. *Aviation, Space, and Environmental Medicine*, 77(2):164–164.
- Lewis, J., Shires, L., and Brown, D. (2012). Development of a visual impairment simulator using the microsoft xna framework. In *Proceedings of the the 9th International Conference on Disability, Virtual Reality and Associated Technologies*, pages 10–12.
- Lindau, A. and Brinkmann, F. (2012). Perceptual evaluation of headphone compensation in binaural synthesis based on non-individual recordings. *J. Audio Eng. Soc.*, 60(1/2):54–62.
- Lobjois, R., Benguigui, N., and Cavallo, V. (2013). The effects of age and traffic density on street-crossing behavior. *Accident Analysis & Prevention*, 53:166 – 175.
- Lobjois, R. and Cavallo, V. (2009). The effects of aging on street-crossing behavior: From estimation to actual crossing. *Accident Analysis & Prevention*, 41(2):259 – 267.
- Loomis, J. M., Klatzky, R. L., McHugh, B., and Giudice, N. A. (2012). Spatial working memory for locations specified by vision and audition: Testing the amodality hypothesis. *Attention, Perception, & Psychophysics*, 74(6):1260–1267.

- Loomis, J. M., Lippa, Y., Klatzky, R. L., and Golledge, R. G. (2002). Spatial updating of locations specified by 3-d sound and spatial language. *Journal of Experimental Psychology: Learning, Memory, and Cognition*, 28(2):335.
- Majdak, P., Masiero, B., and Fels, J. (2013). Sound localization in individualized and non-individualized crosstalk cancellation systems. *The Journal of the Acoustical Society of America*, 133(4):2055–2068.
- McClure, M., Hart, P., Jackson, A., Stevenson, M., and Chakravarthy, U. (2000). Macular degeneration: do conventional measurements of impaired visual function equate with visual disability? *The British Journal of Ophthalmology*, 84:244–250.
- Mehra, R., Rungta, A., Golas, A., Lin, M., and Manocha, D. (2015). Wave: Interactive wave-based sound propagation for virtual environments. *IEEE Transactions on Visualization and Computer Graphics*, 21(4):434–442.
- Meir, A., Oron-Gilad, T., and Parmet, Y. (2015). Are child-pedestrians able to identify hazardous traffic situations? measuring their abilities in a virtual reality environment. *Safety Science*, 80:33 – 40.
- Middlebrooks, J. and M. Green, D. (1991). Sound localization by human listeners. *Annual review of psychology*, 42:135–59.
- Møller, H., Sørensen, M. F., Jensen, C. B., and Hammershøi, D. (1996). Binaural technique: Do we need individual recordings? *Journal of the Audio Engineering Society*, 44(6):451–469.
- Morrongiello, B. A., Corbett, M., Milanovic, M., Pyne, S., and Vierich, R. (2015). Innovations in using virtual reality to study how children cross streets in traffic: evidence for evasive action skills. *Injury Prevention*, 21(4):266–270.
- Naef, M., Staadt, O., and Gross, M. (2002). Spatialized audio rendering for immersive virtual environments. In *Proceedings of the ACM Symposium on Virtual Reality Software and Technology*, VRST '02, pages 65–72, New York, NY, USA. ACM.
- Nambisan, S. S. and Parini, V. (2007). A comparative evaluation of the safety performance of roundabouts and traditional intersection controls. *Istitute of Transportation Engineers Journal*.
- Nikolas, M. A., Elmore, A. L., Franzen, L., O’Neal, E., Kearney, J. K., and Plumert, J. M. (2016). Risky bicycling behavior among youth with and without attention-deficit hyperactivity disorder. *Journal of Child Psychology and Psychiatry*, 57(2):141–148.
- O’Neal, E. E., Jiang, Y., Franzen, L. J., Rahimian, P., Yon, J. P., Kearney, J. K., and Plumert, J. M. (2017). Changes in perception-action tuning over long time scales: How children and adults perceive and act on dynamic affordances when crossing roads. *Journal of experimental psychology. Human perception and performance*.

- O’Neal, E. E., Jiang, Y., Franzen, L. J., Rahimian, P., Yon, J. P., Kearney, J. K., and Plumert, J. M. (2018). Changes in perception–action tuning over long time scales: How children and adults perceive and act on dynamic affordances when crossing roads. *Journal of experimental psychology: human perception and performance*, 44(1):18.
- Oxley, J., Fildes, B., Ihsen, E., Charlton, J., and Day, R. (1997). Differences in traffic judgements between young and old adult pedestrians. *Accident Analysis & Prevention*, 29(6):839 – 847.
- Pamplona, V. F., Passos, E. B., Zizka, J., Oliveira, M. M., Lawson, E., Clua, E., and Raskar, R. (2011). Catra: Interactive measuring and modeling of cataracts. In *ACM SIGGRAPH 2011 Papers*, pages 47:1–47:8. ACM.
- Picinali, L., Afonso, A., Denis, M., and Katz, B. F. G. (2014). Exploration of architectural spaces by blind people using auditory virtual reality for the construction of spatial knowledge. *Int. J. Hum.-Comput. Stud.*, 72(4):393–407.
- Plumert, J. and K. Kearney, J. (2014). How do children perceive and act on dynamic affordances in crossing traffic-filled roads? *Child Development Perspectives*, 8.
- Plumert, J. M. and Kearney, J. K. (2014). Linking decisions and actions in dynamic environments: How child and adult cyclists cross roads with traffic. *Ecological Psychology*, 26(1-2):125–133.
- Plumert, J. M., Kearney, J. K., and Cremer, J. F. (2004). Children’s perception of gap affordances: Bicycling across traffic-filled intersections in an immersive virtual environment. *Child Development*, 75(4):1243-1253.
- Plumert, J. M., Kearney, J. K., and Cremer, J. F. (2007). Children’s road crossing: A window into perceptual-motor development. *Current Directions in Psychological Science*, 16(5):255–258.
- Ranjan, R. and Gan, W. S. (2015). Natural listening over headphones in augmented reality using adaptive filtering techniques. *IEEE/ACM Transactions on Audio, Speech, and Language Processing*, 23(11):1988–2002.
- Riecke, B. E., Våljamäe, A., and Schulte-Pelkum, J. (2009). Moving sounds enhance the visually-induced self-motion illusion (circular vection) in virtual reality. *ACM Transactions on Applied Perception (TAP)*, 6(2):7.
- Romigh, G. D. and Simpson, B. D. (2014). Do you hear where i hear?: isolating the individualized sound localization cues. *Frontiers in Neuroscience*, 8:370.
- Rosenbloom, T., Nemrodov, D., and Barkan, H. (2004). For heavens sake follow the rules: pedestrians behavior in an ultra-orthodox and a non-orthodox city. *Transportation Research Part F: Traffic Psychology and Behaviour*, 7(6):395 – 404.

- Rouder, J. N., Speckman, P. L., Sun, D., Morey, R. D., and Iverson, G. (2009). Bayesian t-tests for accepting and rejecting the null hypothesis. *Psychonomic Bulletin & Review*, 16:225–237.
- Rouphail, N., Hughes, R., and Chae, K. (2005). Exploratory simulation of pedestrian crossings at roundabouts. *ASCE Journal of Transportation Engineering*, 131(3):211–218.
- Schiff, W. and Oldak, R. (1990). Accuracy of judging time to arrival: effects of modality, trajectory, and gender. *Journal of Experimental Psychology: Human Perception and Performance*, 16(2):303–316.
- Schissler, C., Nicholls, A., and Mehra, R. (2016). Efficient hrtf-based spatial audio for area and volumetric sources. *IEEE Transactions on Visualization and Computer Graphics*, 22(4):1356–1366.
- Schwebel, D. C., Gaines, J., and Severson, J. (2008). Validation of virtual reality as a tool to understand and prevent child pedestrian injury. *Accident Analysis & Prevention*, 40(4):1394 – 1400.
- Seward, A. E., Ashmead, D. H., and Bodenheimer, B. (2007). Using virtual environments to assess time-to-contact judgments from pedestrian viewpoints. *ACM Transactions on Applied Perception*, 4(3).
- Simpson, G., Johnston, L., and Richardson, M. (2003). An investigation of road crossing in a virtual environment. *Accident Analysis & Prevention*, 35(5):787 – 796.
- Suarez, A. S., Tissieres, J. Y., Vieira, L. S., Hunter-McHardy, R., Sernavski, S. K., and Serafin, S. (2017). A comparison between measured and modelled head-related transfer functions for an enhancement of real-time 3d audio processing for virtual reality environments. In *2017 IEEE 3rd VR Workshop on Sonic Interactions for Virtual Environments (SIVE)*, pages 1–9.
- Sunder, K., HE, J., Tan, E. L., and Gan, W. S. (2015). Natural sound rendering for headphones: Integration of signal processing techniques. *IEEE Signal Processing Magazine*, 32(2):100–113.
- Sunness, J., Margalit, E., Srikumaran, D., Applegate, C., Tian, Y., Perry, D., Hawkins, B., and Bressler, N. (2007). The long-term natural history of geographic atrophy from age-related macular degeneration: Enlargement of atrophy and implications for interventional clinical trials. *Ophthalmology*, 114:271–277.
- Taylor, M., Chandak, A., Mo, Q., Lauterbach, C., Schissler, C., and Manocha, D. (2012). Guided multiview ray tracing for fast auralization. *IEEE Transactions on Visualization and Computer Graphics*, 18(11):1797–1810.
- te Velde, A. F., van der Kamp, J., Barela, J. A., and Savelsbergh, G. J. (2005). Visual timing and adaptive behavior in a road-crossing simulation study. *Accident Analysis & Prevention*, 37(3):399 – 406.

- Thompson, W. B., Willemsen, P., Gooch, A. A., Creem-Regehr, S. H., Loomis, J. M., and Beall, A. C. (2004). Does the quality of the computer graphics matter when judging distances in visually immersive environments. *Presence: Teleoperators and Virtual Environments*, 13:560–571.
- Väyrynen, J., Colley, A., and Häkkinä, J. (2016). Head mounted display design tool for simulating visual disabilities. In *Proceedings of the 15th International Conference on Mobile and Ubiquitous Multimedia*, pages 69–73. ACM.
- Volkman, F. C. (1986). Human visual suppression. *Vision research*, 26(9):1401–1416.
- Wenzel, E. M. and Foster, S. H. (1990). Real-time digital of virtual acoustic environments. *SIGGRAPH Comput. Graph.*, 24(2):139–140.
- Werfel, F., Wiche, R., Feitsch, J., and Geiger, C. (2016). Empathizing audiovisual sense impairments: Interactive real-time illustration of diminished sense perception. In *Proceedings of the 7th Augmented Human International Conference 2016*, pages 15:1–15:8. ACM.
- Wong, W. L., Su, X., Li, X., Cheung, C. M. G., Klein, R., Cheng, C.-Y., and Wong, T. Y. (2014). Global prevalence of age-related macular degeneration and disease burden projection for 2020 and 2040: a systematic review and meta-analysis. *The Lancet Global Health*, 2(2):106–116.
- Wu, H., Ashmead, D. H., Adams, H., and Bodenheimer, B. (2018a). 3d sound rendering in a virtual environment to evaluate pedestrian street crossing decisions at a roundabout. In *2018 IEEE 4th VR Workshop on Sonic Interactions for Virtual Environments (SIVE)*, pages 1–6.
- Wu, H., Ashmead, D. H., Adams, H., and Bodenheimer, B. (2018b). Using virtual reality to assess the street crossing behavior of pedestrians with simulated macular degeneration at a roundabout. *Frontiers in ICT*, 5:27.
- Wu, H., Ashmead, D. H., and Bodenheimer, B. (2009). Using immersive virtual reality to evaluate pedestrian street crossing decisions at a roundabout. In *Proceedings of the 6th Symposium on Applied Perception in Graphics and Visualization, APGV '09*, pages 35–40, New York, NY, USA. ACM.
- Wu, H., Ashmead, D. H., and Bodenheimer, B. (2019). Using virtual reality to evaluate pedestrian street crossing at a roundabout. *ACM Transactions on Applied Perception (under review)*.
- Xie, B. (2013). *Head-Related Transfer Function and Virtual Auditory Display*. J Ross Publishing: Plantation, FL, USA.
- Yamamoto, K. and Igarashi, T. (2017). Fully perceptual-based 3d spatial sound individualization with an adaptive variational autoencoder. *ACM Trans. Graph.*, 36(6):212:1–212:13.

Zahorik, P., Brungart, D. S., and Bronkhorst, A. W. (2005). Auditory distance perception in humans: A summary of past and present research. *Acta Acustica united with Acustica*, 91(3):409–420.

Appendices

Appendix A

Questionnaire for Experiments in Chapter III

1. Please indicate your age and gender.
2. Do you regularly play video games?
 - Yes
 - No

If yes, please guess how many hours per week, on average, you spend playing video games?

If yes, do you regularly play first-person video games (where the viewpoint is as if you are in the game)?

3. Please indicate the most difficult condition (use D) and the easiest condition (use E) that you experienced in this experiment.

	Lack of Blur	Blur
Sounds		
No Sounds		

4. I have had experience crossing traffic roundabouts.
(strongly agree) (strongly disagree)
1 2 3 4 5 6 7
5. My visual ability is normal or corrected to normal.
(strongly agree) (strongly disagree)
1 2 3 4 5 6 7
6. My hearing is normal.
(strongly agree) (strongly disagree)
1 2 3 4 5 6 7
7. Which factor was most helpful when you crossed the street?
 - Lack of Blur
 - Sounds
 - Don't know
8. Do you think the traffic sounds is helpful when you crossed the street?
 - Yes
 - No
 - Don't know

9. Do you think you would be more conservative in a real physical environment with real vehicles than when you did this experiment in our lab?

- Yes
- No
- Don't know