

ANALYSIS OF SPECTRAL PROPERTIES OF SPEECH FOR DETECTING SUICIDE
RISK AND IMPACT OF GENDER SPECIFIC DIFFERENCES

HANDE KAYMAZ KESKINPALA

Thesis under the direction of Professor D. Mitch Wilkes

Depression is a potentially life threatening mood disorder which affects many people. Two thirds of the people with depression don't realize that depression is a treatable illness, only 50% of people diagnosed with major depression receive any kind of treatment, and only 20% of them get treatment. Depression can lead to suicidal behavior. It is very important to realize that depression is a treatable disorder and suicide is a preventable act. A recent research study reported a frightening result which was that 48% of patients who have suicidal ideations and 24% of those who have committed suicide did not receive any care or even perceive the need for care. Therefore, it is very important to evaluate a patient's psychological state and to evaluate a depressed patient's risk of committing suicide, since suicide may be prevented by the psychiatric help. A unique challenge is discriminating the high risk suicidal (HR) patients from the depressed (DP) patients and this dissertation is focused on tackling this challenge.

In this dissertation, two different types of audio recordings from the depressed patients (diagnosed with depression), the high risk suicidal patients (diagnosed with high risk suicide), and the remitted patients (diagnosed with remission from the depression) were gathered and analyzed. One type is audio recordings that were gathered from the clinical interviews (interview session); the other one is gathered while the patients were reading a predetermined passage (reading session).

This dissertation presents three different studies. In the first study, mel-frequency cepstral coefficients (MFCCs) are used to estimate suicidal risk using different numbers of MFCCs with and without environmental compensation. A different approach is proposed to maximize the classification rates of discriminating the high risk suicidal patients from the depressed patients using fewer coefficients. The aim of this research is estimating the suicidal risk using MFCCs with high classification rates and the results show that the MFCCs are useful indicators for DP-HR discrimination.

In the second study, we propose various approaches to maximize the classification rates of discriminating the high risk suicidal patients from the depressed patients using

power spectral density features. In earlier studies, 4 fixed energy bands which are uniformly placed band edges in the 0-2000 Hz frequency range (0-500 Hz, 500- 1000 Hz, 1000-1500 Hz, 1500-2000 Hz) were analyzed. In this study, various optimization techniques are used which are increasing the number of energy bands, increasing the energy band range, increasing the energy band number & range, exponential band edges, exponential band edges & increasing the energy band range, non-uniform band edges, and finally non-uniform band edges & increasing the energy band range. It is found that these approaches provide better classification rates for discriminating the high risk suicidal patients from the depressed patients.

In the last study, gender specific differences on optimized energy bands are investigated. There exist statistically significant gender differences in the Depressed (DP) and the High Risk Suicidal (HR) pairwise group during the interview and reading sessions. 14 statistically significant features are found during the interview session, and 4 statistically significant features are found during the reading session. There are no statistically significant gender differences in the High Risk Suicidal-Remitted (HR-RM) pairwise group during the interview session and during the reading session. There exist statistically significant gender differences in the Depressed (DP) and the Remitted (RM) pairwise group during the interview and reading sessions. 26 statistically significant features are found during the interview session, and 2 statistically significant features are found during the reading session. Spontaneous speech (interview session) is more effective for revealing gender differences than the controlled reading speech (reading session).

ANALYSIS OF SPECTRAL PROPERTIES OF SPEECH FOR DETECTING
SUIKIDE RISK AND IMPACT OF GENDER SPECIFIC DIFFERENCES

By

Hande Kaymaz Keskinpala

Dissertation

Submitted to the Faculty of the
Graduate School of Vanderbilt University

in partial fulfillment of the requirements

for the degree of

DOCTOR OF PHILOSOPHY

in

Electrical Engineering

May, 2011

Nashville, Tennessee

Approved:

Assoc. Professor D. Mitch Wilkes

Professor Richard G. Shiavi

Assoc. Professor Ronald M. Salomon

Professor Alfred B. Bonds

Professor Ralph Ohde

Copyright © 2011 by Hande Kaymaz Keskinpala

All Rights Reserved

This dissertation is dedicated to my beloved husband Turker,
my lovely son Arda, and my great family.

ACKNOWLEDGEMENTS

I am grateful to my academic advisor, Dr. Mitch Wilkes, whose advice and guidance helped me immensely during my PhD research. He not only helped me by giving the right direction and invaluable contributions to my research, but also helped me as a friend during my tough times. This thesis and this degree would not be possible without his guidance and friendship.

I would like to thank Dr. Richard Shiavi for his valuable advice and help on setting the vision for the research project. I would like to thank Dr. Ronald Salomon as well, this thesis would not have been possible without his support. He helped us by providing the necessary speech files and he always gave invaluable feedbacks from the Psychiatry point of view. I would like to thank Dr. Alfred Bonds and Dr. Ralph Ohde for their guidance as well.

I would like to give special thanks to the Department of Electrical Engineering and Computer Science for supporting me with tuitions and assistantships throughout my graduate school career. I am grateful to Dr. Michael Fitzpatrick, Lori Schmidt, and Dr. Julie Johnson for giving me chances to have assistantships during my study. I would like to thank Linda Koger, Flo Wahidi, and Sandy Winters for taking care of everything.

Special thanks to all of my friends in Nashville, in Seattle, and in Turkey who supported me throughout the graduate school.

I would like to thank my parents (Fatma Kaymaz and Yavuz Kaymaz), my sister (Funda Erdemgil), my brother (Dr. Ali Riza Kaymaz), my brother-in-law (Cezmi Erdemgil), my sister-in-law (Derya Kaymaz), my nieces (Eren Erdemgil, Esen Erdemgil,

Ecesu Kaymaz) and my nephew (Yavuz Kaymaz) for always being there, always supporting me and always believing in me. I would also like to thank my extended family for their support and encouragements.

I am very grateful and I would like to thank my husband, Dr. Turker Keskinpala, for his endless love, support, friendship, and help. This thesis would not be possible without his support and belief in me. I love you very much Turker. You are my love, my husband, my friend, my classmate, my officemate, and everything to me. I am blessed to have you in my life.

Finally I would like to thank my 3 year old son, Arda Keskinpala, who was clueless about what his mom has been doing in front of the computer for long hours. He is a big motivational push with his existence without being aware of it. I love you so much Arda, I am blessed to have you in my life. I hope you have academic degrees like mommy and daddy.

TABLE OF CONTENTS

	Page
DEDICATION	ii
ACKNOWLEDGEMENTS	iii
TABLE OF CONTENTS	v
LIST OF TABLES	viii
LIST OF FIGURES	xxii
Chapter	
I. INTRODUCTION	1
II. BACKGROUND AND SIGNIFICANCE	9
1 Human Speech Production Mechanism	9
1.1 Structure of the Human Speech Production Mechanism.....	9
2 Model of the Human Speech Production Mechanism.....	17
3 Physiological Effects of Emotion on Speech Production Mechanism.....	26
4 Effects of Depression on Speech.....	27
5 Effects of Suicidal Risk on Speech	39
6 Significance.....	47
III. OBJECTIVE ESTIMATION OF SUICIDAL RISK USING MEL-FREQUENCY CEPSTRAL COEFFICIENTS	49
Abstract	49
1 Introduction	50
2 Methodology	52
2.1 Database.....	52
2.2 Feature Extraction.....	54
3 Experimental Results of the Mel-Frequency Cepstral Coefficients Study	58
3.1 The Effect of Environmental Compensation on the	

Classification Results	58
3.2 Depressed – High Risk Suicidal (DP-HR) Classification Results Using MFCCs	64
4 Performance Evaluation for the Mel-Frequency Cepstral Coefficients Study	74
4.1 The Effect of Environmental Compensation on the Classification Results	74
4.2 Depressed – High Risk Suicidal (DP-HR) Classification Results Using MFCCs	80
5 Discussion and Conclusion	98
5.1 The Effect of Environmental Compensation on the Classification Results of All Possible Pairwise Groups	98
5.2 Depressed – High Risk Suicidal (DP-HR) Classification Results with Different Numbers of MFCCs and Different Classifiers.....	99
5.3 Optimal Set of MFCCs and Their Effect on the Classification for Depressed – High Risk Suicidal (DP-HR) Pairwise Group	104
IV. OBJECTIVE ESTIMATION OF SUICIDAL RISK USING OPTIMIZED ENERGY BANDS	106
Abstract	106
1 Introduction	108
2 Methodology	109
2.1 Database.....	109
3 Experimental Results of Optimized Energy Band Study	117
3.1 Optimization with Different Numbers of Energy Bands.....	118
3.2 Optimization with Different Energy Band Ranges.....	191
3.3 Optimization with Different Energy Band Edges.....	281
4 Performance Evaluation of Optimized Energy Band Study.....	356
4.1 Performance Evaluation of Female Patients.....	356
4.2 Performance Evaluation of Male Patients	367

5 Discussion and Conclusion	377
5.1 Discussion and Conclusion for the Female Patients.....	377
5.2 Discussion and Conclusion for the Male Patients	406
V. GENDER SPECIFIC DIFFERENCES ON OPTIMIZED ENERGY BANDS.....	432
Abstract	432
1 Introduction	435
2 Methodology	437
2.1 Database.....	437
2.2 Feature Extraction.....	439
3 Experimental Results of Gender Comparison on Optimized Energy Bands	442
3.1 Comparison of Gender for Different Band Ranges & Different Band Numbers	443
Statistically Significant Gender Differences	456
4 Performance Evaluation for the Gender Specific Differences on Optimized Energy Bands	521
5 Discussion and Conclusion	538
VI. SUMMARY AND CONCLUSIONS	545
REFERENCES	550

LIST OF TABLES

Table	Page
Table 1: The Number of the Female Patients in the Database.....	53
Table 2: The Number of the Male Patients in the Database	53
Table 3: Depressed – High Risk Suicidal Classification for the Female Patients (Uncompensated)	58
Table 4: Depressed – High Risk Suicidal Classification for the Male Patients (Uncompensated)	59
Table 5: Depressed – Remitted Classification for the Female Patients (Uncompensated)	59
Table 6: Depressed – Remitted Classification for the Male Patients (Uncompensated)	60
Table 7: High Risk Suicidal – Remitted Classification for the Female Patients (Uncompensated).....	60
Table 8: High Risk Suicidal– Remitted Classification for the Male Patients (Uncompensated)	61
Table 9: Depressed – High Risk Suicidal Classification for the Female Patients (Compensated)	61
Table 10: Depressed – High Risk Suicidal Classification for the Male Patients (Compensated)	62
Table 11: Depressed – Remitted Classification for the Female Patients (Compensated)	62
Table 12: Depressed – Remitted Classification for the Male	

Patients (Compensated)	63
Table 13: High Risk Suicidal – Remitted Classification for the Female	
Patients (Compensated)	63
Table 14: High Risk Suicidal– Remitted Classification for the Male	
Patients (Compensated)	64
Table 15: Female Patients Performance during the Interview Session.....	
	65
Table 16: Female Patients Performance during Reading Session	
	66
Table 17: Male Patients Performance during the Interview Session	
	67
Table 18: Male Patients Performance during Reading Session	
	68
Table 19: Optimal set of MFCCs for Female DP-HR Pairwise Group during the	
Interview Session	71
Table 20: Optimal set of MFCCs for Female DP-HR Pairwise Group during	
Reading Session	72
Table 21: Optimal set of MFCCs for Male DP-HR Pairwise Group during the	
Interview Session	73
Table 22: Optimal set of MFCCs for Male DP-HR Pairwise Group during	
Reading Session	74
Table 23: Optimal MFCC set and Their Classification Performances for Female	
Patients	96
Table 24: Optimal MFCC set and Their Classification Performances for Male	
Patients	97
Table 25: The Number of Female Patients in the Database.....	
	110
Table 26: The Number of Male Patients in the Database	
	110

Table 27a: The Features Used in Optimized Energy Bands Study.....	113
Table 27b: The Frequency Ranges Used in Optimized Energy Bands Study	114
Table 28: The Features Used in Finding Optimized Energy Bands	117
Table 29: The Best Band Number Results for the Female Patients (0 – 2000 Hz)	132
Table 30: The Best Band Number Results for the Male Patients	146
Table 31: The Best Classification Type Comparison Results for the DP – HR Pair of Female Patient.....	149
Table 32: The Best Classification Type Comparison Results for the DP – RM Pair of Female Patients	151
Table 33: The Best Classification Type Comparison Results for the HR – RM Pair of Female Patients	153
Table 34: The Best Classification Type Comparison Results for the DP – HR Pair of Male Patients.....	155
Table 35: The Best Classification Type Comparison Results for the DP – RM Pair of Male Patients.....	158
Table 36: The Best Classification Type Comparison Results for the HR – RM Pair of Male Patien.....	160
Table 37: Comparison of Interview vs. Reading Session Results for the DP – HR Pair of Female Patients	163
Table 38: Comparison of Interview vs. Reading Session Results for the DP – RM Pair of Female Patients	166
Table 39: Comparison of Interview vs. Reading Session Results for the HR – RM Pair of Female Patients	169

Table 40: Comparison of Interview vs. Reading Session Results for the DP – HR	
Pair of Male Patients	172
Table 41: Comparison of Interview vs. Reading Session Results for the DP – RM	
Pair of Male Patient	175
Table 42: Comparison of Interview vs. Reading Session Results for the HR – RM	
Pair of Male Patients	178
Table 43: Comparison of Pairwise Groups for the Female Patients Interview	
Session	181
Table 44: Comparison of Pairwise Groups for the Female Patients Reading	
Session	184
Table 45: Comparison of Pairwise Groups for the Male Patients Interview	
Session	187
Table 46: Comparison of Pairwise Groups for the Male Patients Reading	
Session	190
Table 47: The Best Band Number Results for the Female Patients with	
Different Band Frequency Ranges	207
Table 48: The Best Band Number Results for the Male Patients with Different	
Band Frequency Ranges	223
Table 49: The Best Classification Type Comparison Results for the DP – HR	
Pair of Female Patients	226
Table 50: The Best Classification Type Comparison Results for the DP – RM	
Pair of Female Patients	229
Table 51: The Best Classification Type Comparison Results for the HR – RM	

Pair of Female Patients	232
Table 52: The Best Classification Type Comparison Results for the DP – HR	
Pair of Male Patients	235
Table 53: The Best Classification Type Comparison Results for the DP – RM	
Pair of Male Patients	238
Table 54: The Best Classification Type Comparison Results for the HR – RM	
Pair of Male Patients	241
Table 55: Session Type Comparison Results for the DP – HR Pair of Female	
Patients with Different Band Ranges	245
Table 56: Session Type Comparison Results for the DP – RM Pair of Female	
Patients with Different Band Ranges	249
Table 57: Session Type Comparison Results for the HR – RM Pair of Female	
Patients with Different Band Ranges	253
Table 58: Session Type Comparison Results for the DP – HR Pair of Male	
Patients with Different Band Ranges	257
Table 59: Session Type Comparison Results for the DP – RM Pair of	
Male Patients with Different Band Ranges	261
Table 60: Session Type Comparison Results for the HR – RM Pair of	
Male Patients with Different Band Ranges	265
Table 61: Pair Comparison Results for the Female Patients in Interview	
Session with Different Band Ranges	269
Table 62: Pair Comparison Results for the Female Patients in Reading	
Session with Different Band Ranges	273

Table 63: Pair Comparison Results for the Male Patients in Interview	
Session with Different Band Ranges	277
Table 64: Pair Comparison Results for the Male Patients in Reading	
Session with Different Band Ranges	281
Table 65: Exponential vs. Regular Band Edges Comparison Results with Linear Classification	308
Table 66: Exponential vs. Regular Band Edges Comparison Results with Cross Validated Classification	309
Table 67: Exponential vs. Regular Band Edges Comparison Results with Quadratic Classification	309
Table 68: Possible Four Energy Bands in Non-Uniform Band Study in 0- 2000 Hz	311
Table 69: Non Uniform Band Edges Classification Results for the DP – HR Pair with 0 – 2000 Hz Band Range	319
Table 70: Non Uniform Band Edges Classification Averages for the DP – HR Pair with 0 – 2000 Hz Band Range	320
Table 71: Optimized Non Uniform Band Edges Classification Rates for the DP – HR Pair with the 0 – 2000 Hz Band Range for the Female Patients	321
Table 72: Optimized Non Uniform Band Edges Classification Rates for the DP – HR Pair with 0 – 2000 Hz Band Range for the Male Patient	322
Table 73: Non Uniform Band Edges Classification Results for the DP – HR Pair with 0 – 3000 Hz Band Range	323
Table 74: Non Uniform Band Edges Classification Averages for the	

DP – HR Pair with 0 – 3000 Hz Band Range	327
Table 75: Optimized Non Uniform Band Edges Classification Rates for the DP – HR Pair with the 0 – 3000 Hz Band Range for the Female Patients	355
Table 76: Optimized Non Uniform Band Edges Classification Rates for the DP – HR Pair with the 0 – 3000 Hz Band Range for the Male Patients.....	356
Table 77: Comparison of Performance Evaluation Results for the Female Patients with the Fixed Band Number, the Optimized Band Numbers and the Optimized Band Ranges.....	358
Table 78: Comparison of Performance Evaluation Results for the Female Patients with the Optimized Exponential Band Edges in the 0 – 2000 Hz and 0-3000 Hz Band Ranges	362
Table 79: Comparison of Performance Evaluation Results for the Female Patients with the Non-Uniform Band Edges in the 0 – 2000 Hz and 0-3000 Hz Band Ranges for the DP-HR Pairwise Group	366
Table 80: Comparison of Performance Evaluation Results for the Male Patients with the Fixed Band Number, the Optimized Band Numbers and the Optimized Band Ranges	368
Table 81: Comparison of Performance Evaluation Results for the Male Patients with the Optimized Exponential Band Edges in the 0 – 2000 Hz and 0-3000 Hz Band Ranges	372
Table 82: Comparison of Performance Evaluation Results for the Male Patients with the Non-Uniform Band Edges in the 0 – 2000 Hz and 0-3000 Hz Band Ranges for the DP-HR Pairwise Group.....	376

Table 83: Optimization Results for the Female Patients DP-HR during the Interview Session	393
Table 84: Optimization Results for the Female Patients DP-HR during the Reading Session	395
Table 85: Optimization Results for the Female Patients DP-RM during the Interview Session	396
Table 86: Optimization Results for the Female Patients DP-RM during the Reading Session	398
Table 87: Optimization Results for the Female Patients HR-RM during the Interview Session	399
Table 88: Optimization Results for the Female Patients HR-RM during the Reading Session	400
Table 89: Optimization Results for the Female Patients Using the Linear Classifier	402
Table 90: Optimization Results for the Female Patients Using the Quadratic Classifier	402
Table 91: Optimization Results for the Female Patients Using the Cross Validated Classifier.....	402
Table 92: Optimization Results for the Male Patients DP-HR during the Interview Session	421
Table 93: Optimization Results for the Male Patients DP-HR during the Reading Session	422
Table 94: Optimization Results for the Male Patients DP-RM during	

the Interview Session	423
Table 95: Optimization Results for the Male Patients DP-RM during the Reading Session	425
Table 96: Optimization Results for the Male Patients HR-RM during the Interview Session	426
Table 97: Optimization Results for the Male Patients HR-RM during the Reading Session	427
Table 98: Optimization Results for the Male Patients Using the Linear Classifier.....	428
Table 99: Optimization Results for the Male Patients Using the Quadratic Classifier	428
Table 100: Optimization Results for the Male Patients Using the Cross Validated Classifier.....	429
Table 101: The Number of the Female Patients in the Database.....	437
Table 102: The Number of the Male Patients in the Database	438
Table 103a: The Features Used in Optimized Energy Bands Study.....	441
Table 103b: The Frequency Ranges Used in Optimized Energy Bands Study	442
Table 104: Mean Energy Band Values for 2 bands & 0 – 2000 Hz	457
Table 105: Comparison of Significance Results for 2 bands & 0 – 2000 Hz.....	457
Table 106: Comparison of the Mean Value Shifts of Female and Male Patients for 2 bands & 0 – 2000 Hz	458
Table 107: Mean Energy Band Values for 3 bands & 0 – 2000 Hz	459
Table 108: Comparison of Significance Results for 3 bands & 0 – 2000 Hz.....	460

Table 109: Comparison of Shifts of Female and Male Patients for 3 bands & 0 – 2000 Hz	461
Table 110: Mean Energy Band Values for 4 bands & 0 – 2000 Hz	461
Table 111: Comparison of Significance Results for 4 bands & 0 – 2000 Hz.....	463
Table 112: Comparison of Shifts of Female and Male Patients for 4 bands & 0 – 2000 Hz	464
Table 113: Mean Energy Band Values for 5 bands & 0 – 2000 Hz	464
Table 114: Comparison of Significance Results for 5 bands & 0 – 2000 Hz.....	466
Table 115: Comparison of Shifts of Female and Male Patients for 5 bands & 0 – 2000 Hz	466
Table 116: Mean Energy Band Values for 6 bands & 0 – 2000 Hz	467
Table 117: Comparison of Significance Results for 6 bands & 0 – 2000 Hz.....	468
Table 118: Comparison of Shifts of Female and Male Patients for 6 bands & 0 – 2000 Hz	469
Table 119: Mean Energy Band Values for 7 bands & 0 – 2000 Hz	470
Table 120: Comparison of Significance Results for 7 bands & 0 – 2000 Hz.....	472
Table 121: Comparison of Shifts of Female and Male Patients for 7 bands & 0 – 2000 Hz	473
Table 122: Mean Energy Band Values for 8 bands & 0 – 2000 Hz	474
Table 123: Comparison of Significance Results for 8 bands & 0 – 2000 Hz.....	475
Table 124: Comparison of Sifts of Female and Male Patients for 8 bands & 0 – 2000 Hz	476
Table 125: Mean Energy Band Values for 9 bands & 0 – 2000 Hz	477

Table 126: Comparison of Significance Results for 9 bands & 0 – 2000 Hz.....	479
Table 127: Comparison of Shifts of Female and Male Patients for 9 bands & 0 – 2000 Hz	480
Table 128: Mean Energy Band Values for 10 bands & 0 – 2000 Hz	481
Table 129: Comparison of Significance Results for 10 bands & 0 – 2000.....	482
Table 130: Comparison of Shifts of Female and Male Patients for 10 bands & 0 – 2000 Hz	484
Table 131: Mean Energy Band Values for 2 bands & 0 – 3000 Hz	485
Table 132: Comparison of Significance Results for 2 bands & 0 – 3000 Hz.....	485
Table 133: Comparison of Shifts of Female and Male Patients for 2 bands & 0 – 3000 Hz	486
Table 134: Mean Energy Band Values for 3 bands & 0 – 3000 Hz	486
Table 135: Comparison of Significance Results for 3 bands & 0 – 3000 Hz.....	487
Table 136: Comparison of Shifts of Female and Male Patients for 3 bands & 0 – 3000 Hz	488
Table 137: Mean Energy Band Values for 4 bands & 0 – 3000 Hz	489
Table 138: Comparison of Significance Results for 4 bands & 0 – 3000 Hz.....	490
Table 139: Comparison of Shifts of Female and Male Patients for 4 bands & 0 – 3000 Hz	490
Table 140: Mean Energy Band Values for 5 bands & 0 – 3000 Hz	491
Table 141: Comparison of Significance Results for 5 bands & 0 – 3000 Hz.....	492
Table 142: Comparison of Shifts of Female and Male Patients for 5 bands & 0 – 3000 Hz	493

Table 143: Mean Energy Band Values for 6 bands & 0 – 3000 Hz	494
Table 144: Comparison of Significance Results for 6 bands & 0 – 3000 Hz.....	495
Table 145: Comparison of Shifts of Female and Male Patients for 6 bands & 0 – 3000 Hz	496
Table 146: Mean Energy Band Values for 7 bands & 0 – 3000 Hz	497
Table 147: Comparison of Significance Results for 7 bands & 0 – 3000 Hz.....	498
Table 148: Comparison of Shifts of Female and Male Patients for 7 bands & 0 – 3000 Hz	499
Table 149: Mean Energy Band Values for 8 bands & 0 – 3000 Hz	500
Table 150: Comparison of Significance Results for 8 bands & 0 – 3000 Hz.....	501
Table 151: Comparison of Shifts of Female and Male Patients for 8 bands & 0 – 3000 Hz	502
Table 152: Mean Energy Band Values for 9 bands & 0 – 3000 Hz	503
Table 154: Comparison of Shifts of Female and Male Patients for 9 bands & 0 – 3000 Hz	506
Table 155: Mean Energy Band Values for 10 bands & 0 – 3000 Hz	507
Table 156: Comparison of Significance Results for 10 bands & 0 – 3000 Hz.....	508
Table 157: Comparison of Shifts of Female and Male Patients for 10 bands & 0 – 3000 Hz	510
Table 158: Mean Energy Band Values of Exponential Band Study for 0 – 2000 Hz.....	511
Table 159: Comparison of Significance Results of Exponential Band Study for 0 – 2000 Hz	512

Table 160: Comparison of Shifts of Female and Male Patients of Exponential Band Study for 0 – 2000 Hz	513
Table 161: Mean Energy Band Values of Exponential Band Study for 0 – 3000 Hz	514
Table 162: Comparison of Significance Results of Exponential Band Study for 0 – 3000 Hz.....	515
Table 163: Comparison of Shifts of Female and Male Patients of Exponential Band Study for 0 – 3000 Hz	516
Table 164: Mean Energy Band Values of Non Uniform Band Edge Study for 0 – 2000 Hz.....	517
Table 165: Comparison of Significance Results of Non Uniform Band Edge Study for 0 – 2000 Hz.....	518
Table 166: Comparison of Shifts of Female and Male Patients of Non Uniform Band Edge Study for 0 – 2000 Hz.....	518
Table 167: Mean Energy Band Values of Non Uniform Band Edge Study for 0 – 3000 Hz	519
Table 168: Comparison of Significance Results of Non Uniform Band Edge Study for 0 – 3000 Hz.....	520
Table 169: Comparison of Shifts of Female and Male Patients of Non Uniform Band Edge Study for 0 – 3000 Hz.....	520
Table 170: Statistically Significant Energy Bands during the Interview Session	522
Table 171: Statistically Significant Energy Bands during the Reading Session	523

Table 172: Statistically Significant Energy Bands' Mean Value Shifts of DP-HR (Depressed-High Risk Suicidal) Pairwise Group during the Interview Session	524
Table 173: Statistically Significant Energy Bands' Mean Value Shifts of DP-HR (Depressed-High Risk Suicidal) Pairwise Group during the Reading Session.....	528
Table 174: Statistically Significant Energy Bands' Mean Value Shifts of DP-RM (Depressed-Remitted) Pairwise Group during the Interview Session	530
Table 175: Statistically Significant Energy Bands' Mean Value Shifts of DP-RM (Depressed-Remitted) Pairwise Group during the Reading Session	537

LIST OF FIGURES

Figure	Page
Figure 1: The Human Speech Production Mechanism [52].....	10
Figure 2: The Human Vocal Organs (1: Nasal Cavity, 2: Hard Palate, 3: Alveolar Ridge 4: Soft Palate (Velum), 5: Tip of the Tongue (Apex), 6: Dorsum, 7: Uvula, 8: Radix, 9: Pharynx, 10: Epiglottis, 11: False Vocal Cords, 12: Vocal Cords, 13: Larynx, 14: E	11
Figure 3: Block Diagram of Human Speech Production Mechanism [52].....	12
Figure 4: Distinction between Voiced and Unvoiced Speech	13
Figure 5: Human Speech Production System with Voiced and Unvoiced Sound Distinction	14
Figure 6: Major Systems of Human Speech Production Mechanism	15
Figure 7: Human Vocal Tract	16
Figure 8: Block Diagram Representation of Discrete Time Model of the Human Speech Production Mechanism	18
Figure 9: Source- Filter Model and Corresponding Spectra.....	18
Figure 10: Excitation Model of the Human Speech Production	20
Figure 11: Schematic Model of the Human Vocal Tract System [4]	21
Figure 12: (a) The Vocal Tract, Modeled as a Single Dimensional Acoustic Tube of Varying Cross-Sectional Area and (b) An Eight Tube Model Suitable for Discretization.....	22
Figure 13: Non-uniform Acoustic Tube Representation of Vocal Tract with Cascading Acoustic Tubes with Different Cross-Sectional Areas	23

Figure 14: Radiation model part of the Human Speech Production Mechanism	24
Figure 15: (a) Equivalent Circuit of Circular Orifice in an Infinite Plane (b) Equivalent electrical circuit of circular orifice in a Sphere.	25
Figure 16: Mapping between Linearly Spaced Frequency and Mel-Scale Frequency	55
Figure 17: Procedure for Extraction of Mel-Frequency Cepstral Coefficients.....	56
Figure 18: Female Depressed-High Risk Suicidal (DP-HR) Pairwise Group Classification	75
Figure 19: Male Depressed-High Risk Suicidal (DP-HR) Pairwise Group Classification	76
Figure 20: Female Depressed-Remitted (DP-RM) Pairwise Group Classification	77
Figure 21: Male Depressed-Remitted (DP-RM) Pairwise Group Classification.....	78
Figure 22: Female High Risk Suicidal-Remitted (HR-RM) Pairwise Group Classification	79
Figure 23: Male High Risk Suicidal-Remitted (HR-RM) Pairwise Group Classification	80
Figure 24: Female HR Performance in the DP-HR Pairwise Group during the Interview Session.....	81
Figure 25: Female DP Performance in the DP-HR Pairwise Group during the Interview Session.....	82
Figure 26: Female DP-HR Performance in the DP-HR Pairwise Group during the Interview Session	83
Figure 27: Female HR Performance in the DP-HR Pairwise Group during the Reading Session	84

Figure 28: Female DP Performance in the DP-HR Pairwise Group during the Reading Session	86
Figure 29: Female DP-HR Performance in the DP-HR Pairwise Group during the Reading Session.....	87
Figure 30: Male HR Performance in the DP-HR Pairwise Group during the Interview Session	88
Figure 31: Male DP Performance in the DP-HR Pairwise Group during the Interview Session	90
Figure 32: Male DP-HR Performance in the DP-HR Pairwise Group during the Interview Session	91
Figure 33: Male HR Performance in the DP-HR Pairwise Group during the Reading Session	93
Figure 34: Male DP Performance in the DP-HR Pairwise Group during the Reading Session	94
Figure 35: Male DP-HR Performance in the DP-HR Pairwise Group during the Reading Session	95
Figure 36: Spectral Energy Feature Extraction Algorithm Flowchart (for 4 equal bands in the 0-2000 Hz band range)	112
Figure 37 : Female DP – HR Interview Session.....	119
Figure 38: Female DP – HR Reading Session	120
Figure 39: Female DP – HR Interview Session	121
Figure 40: Female DP – HR Reading Session	121
Figure 41: Female DP – HR Interview Session	122

Figure 42: Female DP – HR Reading Session	123
Figure 43: Female DP – RM Interview Session	124
Figure 44: Female DP – RM Reading Session	124
Figure 45: Female DP – RM Interview Session	125
Figure 46: Female DP – RM Reading Session	125
Figure 47:Female DP – RM Interview Session	126
Figure 48: Female DP – RM Reading Session	127
Figure 49: Female HR – RM Interview Session.....	128
Figure 50: Female HR – RM Reading Session.....	128
Figure 51: Female HR – RM Interview Session.....	129
Figure 52: Female HR – RM Reading Session.....	130
Figure 53: Female HR – RM Interview Session.....	131
Figure 54: Female HR – RM Reading Session.....	131
Figure 55: Male DP – HR Interview Session.....	134
Figure 56: Male DP – HR Reading Session.....	134
Figure 57: Male DP – HR Interview Session.....	135
Figure 58: Male DP – HR Reading Session.....	135
Figure 59: Male DP – HR Interview Session.....	136
Figure 60: Male DP – HR Reading Session.....	137
Figure 61: Male DP – RM Interview Session.....	138
Figure 62: Male DP – RM Reading Session.....	138
Figure 63: Male DP – RM Interview Session.....	139
Figure 64: Male DP – RM Reading Session.....	139

Figure 65: Male DP – RM Interview Session.....	140
Figure 66: Male DP – RM Reading Session.....	141
Figure 67: Male HR – RM Interview Session	142
Figure 68: Male HR – RM Reading Session	142
Figure 69: Male HR – RM Interview Session	143
Figure 70: Male HR – RM Reading Session	143
Figure 71: Male HR – RM Interview Session	144
Figure 72: Male HR – RM Reading Session	145
Figure 73: Female DP – HR Interview Session.....	148
Figure 74: Female DP – HR Reading Session.....	148
Figure 75: Female DP – RM Interview Session	150
Figure 76: Female DP – RM Reading Session	151
Figure 77: Female HR – RM Interview Session.....	152
Figure 78: Female HR – RM Reading Session.....	153
Figure 79: Male DP – HR Interview Session.....	154
Figure 80: Male DP – HR Reading Session.....	155
Figure 81: Male DP – RM Interview Session.....	156
Figure 82: Male DP – RM Reading Session.....	157
Figure 83: Male HR – RM Interview Session	158
Figure 84: Male HR – RM Reading Session	159
Figure 85: Female DP – HR Linear Classification	161
Figure 86: Female DP – HR Cross Validated Classification.....	162
Figure 87: Female DP – HR Quadratic Classification.....	162

Figure 88: Female DP – RM Linear Classification	164
Figure 89: Female DP – RM Cross Validated Classification	164
Figure 90: Female DP – RM Quadratic Classification	165
Figure 91: Female HR – RM Linear Classification	167
Figure 92: Female HR – RM Cross Validated Classification.....	168
Figure 93: Female HR – RM Quadratic Classification.....	168
Figure 94: Male DP – HR Linear Classification.....	170
Figure 95: Male DP – HR Cross Validated Classification	170
Figure 96: Male DP – HR Quadratic Classification	171
Figure 97: Male DP – RM Linear Classification	173
Figure 98: Male DP – RM Cross Validated Classification.....	173
Figure 99: Male DP – RM Quadratic Classification.....	174
Figure 100: Male HR – RM Linear Classification.....	176
Figure 101: Male HR – RM Cross Validated Classification	176
Figure 102: Male HR – RM Quadratic Classification	177
Figure 103: Female Interview Session with Linear Classification	179
Figure 104: Female Interview Session with Cross Validated Classification	180
Figure 105: Female Interview Session with Quadratic Classification.....	181
Figure 106: Female Reading Session with Linear Classification	182
Figure 107: Female Reading Session with Cross Validated Classification.....	183
Figure 108: Female Reading Session with Quadratic Classification.....	184
Figure 109: Male Interview Session with Linear Classification.....	185
Figure 110: Male Interview Session with Cross Validated Classification	186

Figure 111: Male Interview Session with Quadratic Classification	187
Figure 112: Male Reading Session with Linear Classification.....	188
Figure 113: Male Reading Session with Cross Validated Classification	189
Figure 114: Male Reading Session with Quadratic Classification	190
Figure 115: Female DP – HR Interview Session	193
Figure 116: Female DP – HR Reading Session	193
Figure 117: Female DP – HR Interview Session	194
Figure 118: Female DP – HR Reading Session	195
Figure 119: Female DP – HR Interview Session	196
Figure 120: Female DP – HR Reading Session	196
Figure 121: Female DP – RM Interview Session	197
Figure 122: Female DP – RM Reading Session	198
Figure 123: Female DP – RM Interview Session	199
Figure 124: Female DP – RM Reading Session	199
Figure 125: Female DP – RM Interview Session	200
Figure 126: Female DP – RM Reading Session	201
Figure 127: Female HR – RM Interview Session.....	202
Figure 128: Female HR – RM Reading Session.....	202
Figure 129: Female HR – RM Interview Session.....	204
Figure 130: Female HR – RM Reading Session.....	204
Figure 131: Female HR – RM Interview Session.....	205
Figure 132: Female HR – RM Reading Session.....	206
Figure 133: Male DP – HR Interview Session.....	208

Figure 134: Male DP – HR Reading Session.....	209
Figure 135: Male DP – HR Interview Session.....	210
Figure 136: Male DP – HR Reading Session.....	210
Figure 137: Male DP – HR Interview Session.....	211
Figure 138: Male DP – HR Reading Session.....	212
Figure 139: Male DP – RM Interview Session.....	213
Figure 140: Male DP – RM Reading Session.....	214
Figure 141: Male DP – RM Interview Session.....	215
Figure 142: Male DP – RM Reading Session.....	215
Figure 143: Male DP – RM Interview Session.....	217
Figure 144: Male DP – RM Reading Session.....	217
Figure 145: Male HR – RM Interview Session	218
Figure 146: Male HR – RM Reading Session	219
Figure 147: Male HR – RM Interview Session	220
Figure 148: Male HR – RM Reading Session	220
Figure 149: Male HR – RM Interview Session	221
Figure 150: Male HR – RM Reading Session	222
Figure 151: Classification Type Comparison Results for the DP – HR Pair of Female Patients Interview Session	224
Figure 152: Classification Type Comparison Results for the DP – HR Pair of Female Patients Reading Session	225
Figure 153: Classification Type Comparison Results for the DP – RM Pair of Female Patients Interview Session	227

Figure 154: Classification Type Comparison Results for the DP – RM Pair of Female Patients Reading Session	228
Figure 155: Classification Type Comparison Results for the HR – RM Pair of Female Patients Interview Session	230
Figure 156: Classification Type Comparison Results for the HR – RM Pair of Female Patients Reading Session	231
Figure 157: Classification Type Comparison Results for the DP– HR Pair of Male Patients Interview Session.....	233
Figure 158: Classification Type Comparison Results for the DP– HR Pair of Male Patients Reading Session.....	234
Figure 159: Classification Type Comparison Results for the DP– RM Pair of Male Patients Interview Session	236
Figure 160: Classification Type Comparison Results for the DP– RM Pair of Male Patients Reading Session	237
Figure 161: Classification Type Comparison Results for the HR– RM Pair of Male Patients Interview Session.....	239
Figure 162: Classification Type Comparison Results for the HR– RM Pair of Male Patients Reading Session.....	240
Figure 163: Comparison of Sessions for the Female DP – HR with Linear Classification	242
Figure 164: Comparison of Sessions for the Female DP – HR with Cross Validated Classification.....	243
Figure 165: Comparison of Sessions for the Female DP – HR	

with Quadratic Classification.....	244
Figure 166: Comparison of Sessions for the Female DP – RM with Linear Classification.....	246
Figure 167: Comparison of Sessions for the Female DP – RM with Cross Validated Classification.....	247
Figure 168: Comparison of Sessions for the Female DP – RM with Quadratic Classification.....	248
Figure 169: Comparison of Sessions for the Female HR – RM with Linear Classification.....	250
Figure 170: Comparison of Sessions for the Female HR – RM with Cross Validated Classification.....	251
Figure 171: Comparison of Sessions for the Female HR – RM with Quadratic Classification.....	252
Figure 172: Comparison of Sessions for the Male DP – HR with Linear Classification.....	254
Figure 173: Comparison of Sessions for the Male DP – HR with Cross Validated Classification.....	255
Figure 174: Comparison of Sessions for the Male DP – HR with Quadratic Classification.....	256
Figure 175: Comparison of Sessions for the Male DP – RM with Linear Classification.....	258
Figure 176: Comparison of Sessions for the Male DP – RM with Cross Validated Classification.....	259

Figure 177: Comparison of Sessions for the Male DP – RM with Quadratic Classification.....	260
Figure 178: Comparison of Sessions for the Male HR – RM with Linear Classification.....	262
Figure 179: Comparison of Sessions for the Male HR – RM with Cross Validated Classification.....	263
Figure 180: Comparison of Sessions for the Male HR – RM with Quadratic Classification.....	264
Figure 181: Comparison of Pairs for the Female Patients in Interview Session with Linear Classification	266
Figure 182: Comparison of Pairs for the Female Patients in Interview Session with Cross Validated Classification	267
Figure 183: Comparison of Pairs for the Female Patients in Interview Session with Quadratic Classification	268
Figure 184: Comparison of Pairs for the Female Patients in Reading Session with Linear Classification	270
Figure 185: Comparison of Pairs for the Female Patients in Reading Session with Cross Validated Classification	271
Figure 186: Comparison of Pairs for the Female Patients in Reading Session with Quadratic Classification	272
Figure 187: Comparison of Pairs for the Male Patients in Interview Session with Linear Classification	274
Figure 188: Comparison of Pairs for the Male Patients in	

Interview Session with Cross Validated Classification	275
Figure 189: Comparison of Pairs for the Male Patients in	
Interview Session with Quadratic Classification	276
Figure 190: Comparison of Pairs for the Male Patients in	
Reading Session with Linear Classification	278
Figure 191: Comparison of Pairs for the Male Patients in	
Reading Session with Cross Validated Classification	279
Figure 192: Comparison of Pairs for the Male Reading with	
Quadratic Classification.....	280
Figure 193: Comparison of Exponential Band Edges and	
Regular Band Edges for the Female DP- HR Interview (0-2000 Hz)	283
Figure 194: Comparison of Exponential Band Edges and	
Regular Band Edges for the Female DP- HR Reading (0-2000 Hz)	284
Figure 195: Comparison of Exponential Band Edges and	
Regular Band Edges for the Female DP- RM Interview (0-2000 Hz).....	285
Figure 196: Comparison of Exponential Band Edges and	
Regular Band Edges for the Female DP- RM Reading (0-2000 Hz).....	286
Figure 197: Comparison of Exponential Band Edges	
and Regular Band Edges for the Female HR- RM Interview (0-2000 Hz)	287
Figure 198: Comparison of Exponential Band Edges and Regular	
Band Edges for the Female HR- RM Reading (0-2000 Hz).....	288
Figure 199: Comparison of Exponential Band Edges and Regular	
Band Edges for the Male DP- HR Interview (0-2000 Hz).....	289

Figure 200: Comparison of Exponential Band Edges and Regular Band Edges for the Male DP- HR Reading (0-2000 Hz).....	290
Figure 201: Comparison of Exponential Band Edges and Regular Band Edges for the Male DP- RM Interview (0-2000 Hz).....	291
Figure 202: Comparison of Exponential Band Edges and Regular Band Edges for the Male DP- RM Reading (0-2000 Hz).....	292
Figure 203: Comparison of Exponential Band Edges and Regular Band Edges for the Male HR- RM Interview (0-2000 Hz)	293
Figure 204: Comparison of Exponential Band Edges and Regular Band Edges for the Male HR- RM Reading (0-2000 Hz)	294
Figure 205: Comparison of Exponential Band Edges and Regular Band Edges for the Female DP - HR Interview (0-3000 Hz).....	296
Figure 206: Comparison of Exponential Band Edges and Regular Band Edges for the Female DP - HR Reading (0-3000 Hz)	297
Figure 207: Comparison of Exponential Band Edges and Regular Band Edges for the Female DP - RM Interview (0-3000 Hz)	298
Figure 208: Comparison of Exponential Band Edges and Regular Band Edges for the Female DP - RM Reading (0-3000 Hz)	299
Figure 209: Comparison of Exponential Band Edges and Regular Band Edges for the Female HR - RM Interview (0-3000 Hz).....	300
Figure 210: Comparison of Exponential Band Edges and Regular Band Edges for the Female HR - RM Reading (0-3000 Hz).....	301
Figure 211: Comparison of Exponential Band Edges and Regular	

Band Edges for the Male DP – HR Interview (0-3000 Hz).....	302
Figure 212: Comparison of Exponential Band Edges and Regular	
Band Edges for the Male DP – HR Reading (0-3000 Hz).....	303
Figure 213: Comparison of Exponential Band Edges and Regular	
Band Edges for the Male DP – RM Interview (0-3000 Hz)	304
Figure 214: Comparison of Exponential Band Edges and Regular	
Band Edges for the Male DP – RM Reading (0-3000 Hz)	305
Figure 215: Comparison of Exponential Band Edges and Regular	
Band Edges for the Male HR – RM Interview (0-3000 Hz).....	306
Figure 216: Comparison of Exponential Band Edges and Regular	
Band Edges for the Male HR – RM Reading (0-3000 Hz).....	307
Figure 217: Non Uniform Band Edges Classification Results for the	
Female DP – HR Interview with 0 – 2000 Hz Band Range with Linear Classifier	312
Figure 218: Non Uniform Band Edges Classification Results for the Female	
DP – HR Interview with 0 – 2000 Hz Band Range with Quadratic Classifier	313
Figure 219: Non Uniform Band Edges Classification Results for the Female	
DP – HR Reading with 0 – 2000 Hz Band Range with Linear Classifier	313
Figure 220: Non Uniform Band Edges Classification Results for the Female	
DP – HR Reading with 0 – 2000 Hz Band Range with Quadratic Classifier	314
Figure 221: Non Uniform Band Edges Classification Results for the Male	
DP – HR Interview with 0 – 2000 Hz Band Range with Linear Classifier	315
Figure 222: Non Uniform Band Edges Classification Results for the Male	
DP – HR Interview with 0 – 2000 Hz Band Range with Quadratic Classifier	316

Figure 223: Non Uniform Band Edges Classification Results for the Male	
DP – HR Reading with 0 – 2000 Hz Band Range with Linear Classifier	317
Figure 224: Non Uniform Band Edges Classification Results for the Male	
DP – HR Reading with 0 – 2000 Hz Band Range with Quadratic Classifier	317
Figure 225: Non Uniform Band Edges Classification Results for the Female	
DP – HR Interview with the 0 – 3000 Hz Band Range with the Linear Classifier	328
Figure 226: Zoom In Graph between Points 1 – 33 (of Figure 225)	328
Figure 227: Zoom In Graph between Points 34 – 66 (of Figure 225)	329
Figure 228: Zoom In Graph between Points 67 – 99 (of Figure 225)	329
Figure 229: Zoom In Graph between Points 100 – 132 (of Figure 225)	329
Figure 230: Zoom In Graph between Points 133 – 165 (of Figure 225)	330
Figure 231: Non Uniform Band Edges Classification Results for the Female	
DP – HR Interview with the 0 – 3000 Hz Band Range with the Quadratic Classifier ...	331
Figure 232: Zoom In Graph between Points 1 – 33 (Female DP – HR Interview between 0 – 3000 Hz Band Range with Quadratic Classifier)	332
Figure 233: Zoom In Graph between Points 34 – 66 (Female DP – HR Interview between 0 – 3000 Hz Band Range with Quadratic Classifier)	332
Figure 234: Zoom In Graph between Points 67 – 99 (Female DP – HR Interview between 0 – 3000 Hz Band Range with Quadratic Classifier)	333
Figure 235: Zoom In Graph between Points 100 – 132 (Female DP – HR Interview between 0 – 3000 Hz Band Range with Quadratic Classifier)	333
Figure 236: Zoom In Graph between Points 133 – 165 (Female DP – HR Interview between 0 – 3000 Hz Band Range with Quadratic Classifier)	334

Figure 237: Non Uniform Band Edges Classification Results for the Female DP – HR Reading with the 0 – 3000 Hz Band Range with the Linear Classifier	335
Figure 238: Zoom In Graph between Points 1 – 33 (Female DP – HR Reading between 0 – 3000 Hz Band Range with Linear Classifier).....	336
Figure 239: Zoom In Graph between Points 34 – 66 (Female DP – HR Reading between 0 – 3000 Hz Band Range with Linear Classifier).....	336
Figure 240: Zoom In Graph between Points 67 – 99 (Female DP – HR Reading between 0 – 3000 Hz Band Range with Linear Classifier).....	336
Figure 241: Zoom In Graph between Points 100 – 132 (Female DP – HR Reading between 0 – 3000 Hz Band Range with Linear Classifier)	337
Figure 242: Zoom In Graph between Points 133 – 165 (Female DP – HR Reading between 0 – 3000 Hz Band Range with Linear Classifier)	337
Figure 243: Non Uniform Band Edges Classification Results for the Female DP – HR Reading with the 0 – 3000 Hz Band Range with the Quadratic Classifier	338
Figure 244: Zoom In Graph between Points 1 – 33 (Female DP – HR Reading between 0 – 3000 Hz Band Range with Quadratic Classifier)	339
Figure 245: Zoom In Graph between Points 34 – 66 (Female DP – HR Reading between 0 – 3000 Hz Band Range with Quadratic Classifier)	339
Figure 246: Zoom In Graph between Points 67 – 99 (Female DP – HR Reading between 0 – 3000 Hz Band Range with Quadratic Classifier)	340
Figure 247: Zoom In Graph between Points 100 – 132 (Female DP – HR Reading between 0 – 3000 Hz Band Range with Quadratic Classifier).....	340
Figure 248: Zoom In Graph between Points 133 – 165 (Female DP – HR	

Reading between 0 – 3000 Hz Band Range with Quadratic Classifier)	341
Figure 249: Non Uniform Band Edges Classification Results for the Male	
DP – HR Interview with the 0 – 3000 Hz Band Range with the Linear Classifier	342
Figure 250: Zoom In Graph between Points 1 – 33 (Male DP – HR Interview	
between 0 – 3000 Hz Band Range with Linear Classifier).....	342
Figure 251: Zoom In Graph between Points 34 – 66 (Male DP – HR Interview	
between 0 – 3000 Hz Band Range with Linear Classifier).....	343
Figure 252: Zoom In Graph between Points 67 – 99 (Male DP – HR Interview	
between 0 – 3000 Hz Band Range with Linear Classifier).....	343
Figure 253: Zoom In Graph between Points 100 – 132 (Male DP – HR Interview	
between 0 – 3000 Hz Band Range with Linear Classifier).....	343
Figure 254: Zoom In Graph between Points 133 – 165 (Male DP – HR Interview	
between 0 – 3000 Hz Band Range with Linear Classifier).....	344
Figure 255: Non Uniform Band Edges Classification Results for the Male	
DP – HR Interview with the 0 – 3000 Hz Band Range with the Quadratic Classifier ...	345
Figure 256: Zoom In Graph between Points 1 – 33 (Male DP – HR Interview	
between 0 – 3000 Hz Band Range with Quadratic Classifier)	346
Figure 257: Zoom In Graph between Points 34 – 66 (Male DP – HR Interview	
between 0 – 3000 Hz Band Range with Quadratic Classifier)	346
Figure 258: Zoom In Graph between Points 67 – 99 (Male DP – HR Interview	
between 0 – 3000 Hz Band Range with Quadratic Classifier)	346
Figure 259: Zoom In Graph between Points 100 – 132 (Male DP – HR Interview	
between 0 – 3000 Hz Band Range with Quadratic Classifier)	347

Figure 260: Zoom In Graph between Points 133 – 165 (Male DP – HR Interview between 0 – 3000 Hz Band Range with Quadratic Classifier)	347
Figure 261: Non Uniform Band Edges Classification Results for the Male DP – HR Reading with the 0 – 3000 Hz Band Range with the Linear Classifier	348
Figure 262: Zoom In Graph between Points 1 – 33 (Male DP – HR Reading between 0 – 3000 Hz Band Range with Linear Classifier).....	349
Figure 263: Zoom In Graph between Points 34 – 66 (Male DP – HR Reading between 0 – 3000 Hz Band Range with Linear Classifier).....	349
Figure 264: Zoom In Graph between Points 67 – 99 (Male DP – HR Reading between 0 – 3000 Hz Band Range with Linear Classifier).....	350
Figure 265: Zoom In Graph between Points 100 – 132 (Male DP – HR Reading between 0 – 3000 Hz Band Range with Linear Classifier).....	350
Figure 266: Zoom In Graph between Points 133 – 165 (Male DP – HR Reading between 0 – 3000 Hz Band Range with Linear Classifier).....	351
Figure 267: Non Uniform Band Edges Classification Results for the Male DP – HR Reading with the 0 – 3000 Hz Band Range with the Quadratic Classifier	352
Figure 268: Zoom In Graph between Points 1 – 33 (Male DP – HR Reading between 0 – 3000 Hz Band Range with Quadratic Classifier)	353
Figure 269: Zoom In Graph between Points 34 – 66 (Male DP – HR Reading between 0 – 3000 Hz Band Range with Quadratic Classifier)	353
Figure 270: Zoom In Graph between Points 67 – 99 (Male DP – HR Reading between 0 – 3000 Hz Band Range with Quadratic Classifier)	354
Figure 271: Zoom In Graph between Points 100 – 132 (Male DP – HR Reading	

between 0 – 3000 Hz Band Range with Quadratic Classifier)	354
Figure 272: Zoom In Graph between Points 133 – 165 (Male DP – HR Reading between 0 – 3000 Hz Band Range with Quadratic Classifier)	355
Figure 273: Female Patients’ Results Comparison with Linear Classifier	378
Figure 274: Female Patients’ Results Comparison with Quadratic Classifier.....	378
Figure 275: Female Patients’ Results Comparison with Cross Validated Classifier	379
Figure 276: Female Patients’ Different Frequency Ranges Results with Linear Classifier	380
Figure 277: Female Patients’ Different Frequency Ranges Results with Quadratic Classifier	381
Figure 278: Female Patients’ Different Frequency Ranges Results with Cross Validated Classifier.....	382
Figure 279: Female Patients’ Results Comparison with Linear Classifier in the 0-3000 Hz Frequency Range	383
Figure 280: Female Patients’ Results Comparison with Quadratic Classifier in the 0-3000 Hz Frequency Range.....	384
Figure 281: Female Patients’ Results Comparison with Cross Validated Classifier in the 0-3000 Hz Frequency Range	384
Figure 282: Female Patients’ Results of Exponential Band Edges with Linear Classifier in the 0-2000 Hz Frequency Range	386
Figure 283: Female Patients’ Results of Exponential Band Edges with Quadratic Classifier in the 0-2000 Hz Frequency Range	386

Figure 284: Female Patients' Results of Exponential Band Edges with Cross Validated Classifier in the 0-2000 Hz Frequency Range.....	387
Figure 285: Female Patients' Results of Exponential Band Edges with Linear Classifier in the 0-3000 Hz Frequency Range	388
Figure 286: Female Patients' Results of Exponential Band Edges with Quadratic Classifier in the 0-3000 Hz Frequency Range	388
Figure 287: Female Patients' Results of Exponential Band Edges with Cross Validated Classifier in the 0-3000 Hz Frequency Range.....	389
Figure 288: Female Patients' Results of Non-Uniform Band Edges with Linear Classifier in the 0-2000 Hz Frequency Range	390
Figure 289: Female Patients' Results of Non-Uniform Band Edges with Quadratic Classifier in the 0-2000 Hz Frequency Range	391
Figure 290: Female Patients' Results of Non-Uniform Band Edges with Linear Classifier in the 0-2000 Hz Frequency Range	392
Figure 291: Female Patients' Results of Non-Uniform Band Edges with Quadratic Classifier in the 0-3000 Hz Frequency Range	392
Figure 292: Female DP-HR Interview Session Result Comparison.....	394
Figure 293: Female DP-HR Reading Session Result Comparison.....	395
Figure 294: Female DP-RM Interview Session Result Comparison	397
Figure 295: Female DP-RM Reading Session Result Comparison	398
Figure 296: Female HR-RM Interview Session Result Comparison.....	399
Figure 297: Female HR-RM Reading Session Result Comparison.....	401
Figure 298: Male Patients' Results Comparison with Linear Classifier.....	406

Figure 299: Male Patients' Results Comparison with Quadratic Classifier	407
Figure 300: Male Patients' Results Comparison with Cross Validated Classifier	407
Figure 301: Male Patients' Different Frequency Ranges Results with Linear Classifier	408
Figure 302: Male Patients' Different Frequency Ranges Results with Quadratic Classifier	409
Figure 303: Male Patients' Different Frequency Ranges Results with Cross Validated Classifier.....	410
Figure 304: Male Patients' Results Comparison with Linear Classifier in the 0-3000 Hz Frequency Range	411
Figure 305: Male Patients' Results Comparison with Quadratic Classifier in the 0-3000 Hz Frequency Range	412
Figure 306: Male Patients' Results Comparison with Cross Validated Classifier in the 0-3000 Hz Frequency Range.....	412
Figure 307: Male Patients' Results of Exponential Band Edges with Linear Classifier in the 0-2000 Hz Frequency Range	413
Figure 308: Male Patients' Results of Exponential Band Edges with Quadratic Classifier in the 0-2000 Hz Frequency Range	414
Figure 309: Male Patients' Results of Exponential Band Edges with Cross Validated Classifier in the 0-2000 Hz Frequency Range	414
Figure 310: Male Patients' Results of Exponential Band Edges with Linear Classifier in the 0-3000 Hz Frequency Range.....	415
Figure 311: Male Patients' Results of Exponential Band Edges with	

Quadratic Classifier in the 0-3000 Hz Frequency Range	416
Figure 312: Male Patients' Results of Exponential Band Edges with Cross Validated Classifier in the 0-3000 Hz Frequency Range	416
Figure 313: Male Patients' Results of Non-Uniform Band Edges with Linear Classifier in the 0-2000 Hz Frequency Range.....	418
Figure 314: Male Patients' Results of Non-Uniform Band Edges with Quadratic Classifier in the 0-2000 Hz Frequency Range	418
Figure 315: Male Patients' Results of Non-Uniform Band Edges with Linear Classifier in the 0-2000 Hz Frequency Range.....	419
Figure 316: Male Patients' Results of Non-Uniform Band Edges with Quadratic Classifier in the 0-3000 Hz Frequency Range	420
Figure 317: Male DP-HR Interview Session Result Comparison	421
Figure 318: Male DP-HR Reading Session Result Comparison	422
Figure 319: Male DP-RM Interview Session Result Comparison.....	424
Figure 320: Male DP-RM Reading Session Result Comparison.....	425
Figure 321: Male HR-RM Interview Session Result Comparison	426
Figure 322: Male HR-RM Reading Session Result Comparison	427
Figure 323: Spectral Energy Feature Extraction Algorithm Flowchart (for 4 equal bands in the 0-2000 Hz band range).....	440
Figure 324: Comparison of the Gender for the DP – HR Pair Interview with the Linear Classification	444
Figure 325: Comparison of the Gender for the DP – HR Pair Interview with the Cross Validated Classification.....	445

Figure 326: Comparison of the Gender for the DP – HR Pair Interview with the Quadratic Classification.....	445
Figure 327: Comparison of the Gender for the DP – HR Pair Reading with the Linear Classification.....	446
Figure 328: Comparison of the Gender for the DP – HR Pair Reading with the Cross Validated Classification.....	447
Figure 329: Comparison of the Gender for the DP – HR Pair Reading with the Quadratic Classification.....	447
Figure 330: Comparison of the Gender for the DP – RM Pair Interview with the Linear Classification.....	448
Figure 331: Comparison of the Gender for the DP – RM Pair Interview with the Cross Validated Classification.....	449
Figure 332: Comparison of the Gender for the DP – RM Pair Interview with the Quadratic Classification.....	449
Figure 333: Comparison of the Gender for the DP – RM Pair Reading with the Linear Classification.....	450
Figure 334: Comparison of the Gender for the DP – RM Pair Reading with the Cross Validated Classification.....	451
Figure 335: Comparison of the Gender for the DP – RM Pair Reading with the Quadratic Classification.....	451
Figure 336: Comparison of the Gender for the HR – RM Pair Interview with the Linear Classification.....	452
Figure 337: Comparison of the Gender for the HR – RM Pair Interview	

with the Cross Validated Classification	453
Figure 338: Comparison of the Gender for the HR – RM Pair Interview	
with the Quadratic Classification	453
Figure 339: Comparison of the Gender for the HR – RM Pair Reading	
with the Linear Classification	454
Figure 340: Comparison of the Gender for the HR – RM Pair Reading	
with the Cross Validated Classification	455
Figure 341: Comparison of the Gender for the HR – RM Pair Reading	
with the Quadratic Classification	455

CHAPTER I

INTRODUCTION

Suicide is a serious, major, preventable public health problem. People may consider suicide when they are hopeless and can't see any other solution to their problems. Suicide is a public health problem since more than 34,000 people kill themselves each year [1] and more than 376,000 people with self-inflicted injuries are treated in emergency rooms each year according to the 2010 report of the Centers for Disease Control and Prevention [1].

Among industrialized countries in 1990, suicide was among the top 10 causes of death [2]. In 1997, the World Health Organization reported that more than 800,000 deaths occur from suicide every year and about 10 million people attempt suicide [3]. In 1997, suicide was the 8th leading cause of death in the United States, in which 10.6 out of every 100,000 people died by suicide. The total number of suicides were approximately 30,535 in 1997 and there were an estimated 500,000 suicide attempts in 1996 [4]. In 1998 approximately 30,000 people died by suicide in the United States, making it the eighth leading cause of death [5].

In 2003, suicide was the 11th leading cause of death among adults and accounted for 30,559 deaths among people aged 18 or older [6]. Individuals who die from suicide, however, represent a fraction of those who consider or attempt suicide. In 2003, there were 348,830 nonfatal emergency department visits by adults aged 18 or older who had harmed themselves [7]. Research suggests that there may be between 8 and 25 attempted

suicides for every suicide death [8]. Among adults aged 18 or older who experienced a past year major depressive episode, 56.3 percent thought, during their worst or most recent episode, that it would be better if they were dead, 40.3 percent thought about committing suicide, 14.5 percent made a suicide plan, and 10.4 percent made a suicide attempt [9].

In 2004, 32,439 people (approximately 11 per 100,000) died by suicide in United States [10]. More than 90% of the people who kill themselves have a diagnosable mental disorder, most commonly a depressive disorder or a substance abuse disorder [11]. Four times as many men as women die by suicide [12], however women attempt suicide two or three times as often as men [13].

According to United States suicide statistics in 2005 [14], suicide is the eleventh leading cause of death for all Americans and 32,637 people died because of suicide. From the same statistics; 25,907 of them were men and 6,730 were women. There were over 800,000 suicide attempts in 2005. According to the statistics of 2005 [14], 1.3 % of all deaths are from suicide, on average one suicide occurs every 16 minutes, suicide is the third leading cause of death for young people aged 15-24 year olds, suicide is the second leading cause of death for 25-34 year olds, suicide is the second leading cause of death among college students, more males die from suicide than females (4 male deaths by suicide for each female death by suicide), and more people die from suicide (11th leading cause of death) than from homicide (13th leading cause of death).

In 2006, suicide was the 11th leading cause of death in the United States [15] and there were more than 33,000 suicides in 1997 which is about 91 per day. Men take their lives nearly four times the rate of women and account for 79% of all suicides in the

United States [15]. Over 90% of people who die by suicide have clinical depression or another diagnosable mental disorder [15].

In 2007, suicide was the tenth leading cause of death in the U.S., accounting for 34,598 deaths [10]. The overall rate was 11.3 suicide deaths per 100,000 people [10]. An estimated 11 attempted suicides occur per every suicide death [10]. Suicide was the seventh leading cause of death for males and the fifteenth leading cause of death for females in 2007 [10]. Almost four times as many males as females die by suicide [10]. In 2007, suicide was the third leading cause of death for young people ages 15 to 24 [10]. There were also gender differences in suicide among young people. Nearly five times as many males as females ages 15 to 19 died by suicide [10]. Just under six times as many males as females ages 20 to 24 died by suicide [10]. Older Americans are disproportionately likely to die by suicide. Of every 100,000 people ages 65 and older, 14.3 died by suicide in 2007. This figure is higher than the national average of 11.3 suicides per 100,000 people in the general population [10]. Non-Hispanic white men age 85 or older had an even higher rate, with 47 suicide deaths per 100,000 [10]. Since research shows that older adults and women who die by suicide are likely to have seen a primary care provider in the year before death, improving a primary-care providers' ability to recognize and treat risk factors may help prevent suicide among these groups [16]. Improving outreach to men at risk is a major challenge in need of investigation [16]. Contact with primary care providers in the time leading up to suicide is common. While three of four suicide victims had contact with primary care providers within the year of suicide, approximately one-third of the suicide victims had contact with mental health services [16]. About one in five suicide victims had contact with mental health services

within a month before their suicide [16]. On average, 45% of suicide victims had contact with primary care providers within 1 month of suicide. Older adults had higher rates of contact with primary care providers within 1 month of suicide than younger adults [16].

Suicide is also an important issue all around the world. The international suicide statistics [17] shows that each year over one million people die because of suicide worldwide and 1.8% of worldwide deaths are because of suicides. The global suicide rate is 16 per 100,000 population. On average, one person dies by suicide every 40 seconds somewhere in the world. Global suicide rates have increased 60% in the past 45 years [17]. Many countries have set targets for suicide reduction, and suggested that mental health care providers and general practitioners have a key role to play. Pirkis and Burgess [18] identified 24 studies which considered whether suicide cases had had recent contact with mental health-care providers and/or primary-care providers [18]. Among those in the general population who commit suicide, up to 41% may have contact with psychiatric inpatient care in the year prior to death and up to 9% may commit suicide within one day of discharge [18].

Depression is also a very common mental health problem worldwide. It is estimated that it will become the second most common cause of disability, after heart disease, by 2020 [19]. Unipolar forms of depression are more common in women than men. In Britain, 3-4% of men and 7-8% of women suffer from moderate to severe depression at any one time [20]. Women are twice as likely to be diagnosed and treated for depression. However, it is believed that men suffer depression to a larger extent than

the statistics show, since men are less likely to seek medical help and when they do, doctors are less likely to detect depressive symptoms [20].

For people with severe depression, the lifetime risk of suicide may be as high as 6% [21], although this figure may be more applicable to those who have been admitted to hospital as a result of depression. For people seen as outpatients or treated by general practitioners, risks are much lower [22].

An international study in 10 countries found that rates of major depression in the community varied from 1.5% in Taiwan to 19% in Beirut. The average age when people began to experience depression was between 25 and 35 years. In every country, rates of major depression among women were higher than those among men [23]. Every week 10% of the UK population aged 16-65 report significant depressive symptoms, and one in 10 of these admit to suicidal thinking [24]. Depression affects approximately 14.8 million American adults or about 6.7% of the U.S. population age 18 or older in 2005 [25]. Depression is more common in women than in men [26].

Research shows that risk factors for suicide include depression and other mental disorders, or a substance-abuse disorder (often in combination with other mental disorders). More than 90 percent of people who die by suicide have these risk factors [8]. Some research shows that depression is one of the most frequent mental health problems in people who die by suicide. [27], [28]. This is also true of young people; major depression is common amongst adolescents who have overdosed [29]. In the United States, around 3.4% of people with major depression commit suicide, and up to 60% of people who commit suicide had depression or another mood disorder [30].

As can be seen from the statistics stated above, suicide and depression are two important health problems. Depression is the most common precursor to suicide [31]. Depressive disorders have been linked to high rates of suicide by Conwell et al. [11], Weissman et al. [32] and Kochanek et al. [12]. According to the National Healthcare Quality Report of 2003, 15% of depressed people will commit suicide [33]. While proper diagnosis and treatment (medication and psychotherapy) is considered effective for 70% to 80% of depressed patients who seek treatment [34], only about 20% of those with depression seek treatment [33]. So, having psychiatric treatment for depression is very important in preventing suicide. Psychological studies from many countries consistently shows that more than 90% of suicide victims have one or more psychiatric illnesses, and the most common one is major depression (59 – 87 %), whereas the rates for schizophrenia and substance use disorders are around 10% [35,36,37, 38].

According to Cheng [35] and Inskip et al. [21], the lifetime risk of suicide for affective disorder is 6 -15%. Even though the lifetime occurrence of depression is close to 20% [39, 40], it remains extremely under-referred, under-diagnosed and under-treated, particularly in primary care [38, 41, 42]. It is reported that 55 – 59 % percent of consecutive depressed suicide victims [37, 43, 44] and 41 – 73% of consecutive suicide victims [45, 18] contact different levels of the health care system (mostly general practitioners) several days, weeks or months before their deaths.

Only 20% of people suffering from depression actually go to their doctor with an emotional problem. The vast majority complain of nonspecific symptoms such as headache, tiredness or vague abdominal pains. This type of “masked” depression is more common in older people, who may feel embarrassed about their condition [46].

In studies which presented the proportion of suicide cases from the general population who had visited a general practitioner within one year of death, estimates were generally consistent, ranging between 73 and 83% in the United Kingdom [47, 48, 49]. Because most elderly suicide victims (70 percent) have visited their primary care physician in the month prior to their suicides, recognition and treatment of depression in the medical setting is a promising way to prevent elderly suicide [4].

In this research, acoustical characteristics of speech will be analyzed and used to distinguish high risk suicidal patients from depressed patients and a control group. Better recognition and more appropriate treatment of depression are very important in suicide prevention. This research could be very useful in helping with development of a diagnostic tool that can assess the risk of committing suicide. Such a tool would enable general practitioners to evaluate the risk of suicide. Furthermore, when people who are suicidal visit a physician's office or emergency room because of another illness, such a diagnostic tool would help with screening of such patients. Finally, this diagnostic tool could complement psychiatrists' existing tools and techniques in evaluating the suicidal risk of their patients.

This dissertation presents background information about the human speech production mechanism, physiological effects of emotion on the speech production mechanism, effects of depression on speech, effects of suicidal risk on speech, and the significance of this research in Chapter II. The third chapter will give detailed information about the objective estimation of suicidal risk using mel-frequency cepstral coefficients (MFCCs), while Chapter IV explores the objective estimation of suicidal risk using optimized energy bands. Gender specific differences on optimized energy bands

will be described in Chapter V. Finally, summary and conclusions will be presented in Chapter 6 and the references will be listed at the end of the dissertation.

CHAPTER II

BACKGROUND AND SIGNIFICANCE

This chapter explores background information about the human speech production mechanism, physiological effects of emotion on speech production mechanism, effects of depression on speech, effects of suicidal risk on speech, and the significance of this research.

1 Human Speech Production Mechanism

Speech is a natural form of communication for humans. A speech signal is an air pressure wave which travels from the speaker's mouth to the listener's ears. In this part of the chapter, the structure of the human speech production mechanism and a model of it will be covered.

1.1 Structure of the Human Speech Production Mechanism

Speech is produced by many different vocal organs. According to Rabiner et al. [50], the main components of the human speech system are the lungs, trachea (windpipe), larynx (organ of speech production), pharyngeal cavity (throat), oral cavity (mouth), and nasal cavity (nose). Holmes [51] considers the lungs, larynx, pharynx, nose and various parts of the mouth to be the organs that are responsible for speech production.

The nasal cavity, hard palate, soft palate (velum), pharyngeal cavity, larynx, esophagus, trachea, nasal cavity, nostril, lip, tongue, teeth, oral cavity, jaw, lungs, and diaphragm are the vocal organs that produce speech. Figure 1 shows the human speech production mechanism and Figure 2 shows the human vocal organs that are used to produce speech.

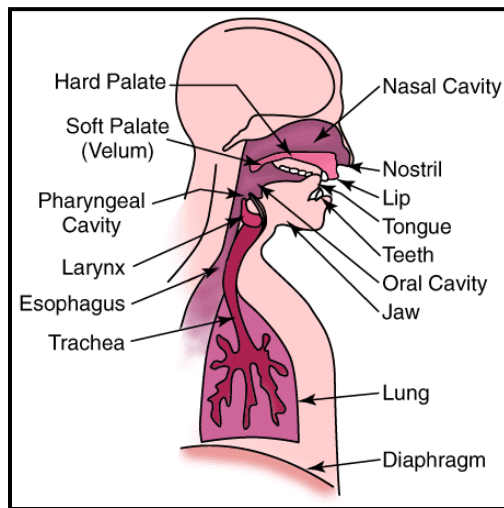

Figure 1: The Human Speech Production Mechanism [52]

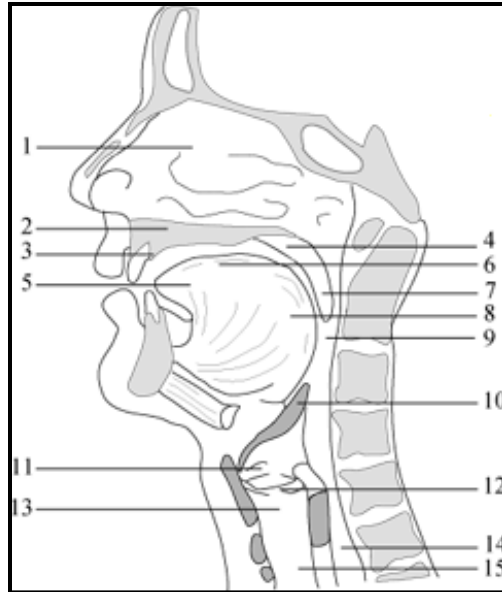

Figure 2: The Human Vocal Organs (1: Nasal Cavity, 2: Hard Palate, 3: Alveolar Ridge
 4: Soft Palate (Velum), 5: Tip of the Tongue (Apex), 6: Dorsum, 7: Uvula, 8: Radix, 9:
 Pharynx, 10: Epiglottis, 11: False Vocal Cords, 12: Vocal Cords, 13: Larynx, 14: E

The main energy source of speech production is the lungs with the diaphragm. When a human is speaking, the air flow is forced through the glottis between the vocal cords and the larynx to the three main cavities of the vocal tract, the pharynx, and the oral and nasal cavities. The air flow exits through the nose for the nasal cavity and through the mouth for the oral cavity. In the vocal system, the most important sound source is the glottis. It is the V-shaped opening between the vocal cords. The oral cavity is another important part of the speech production system. The size, shape and acoustics of the oral cavity can be changed by the movements of tongue, palate, lips, cheeks and teeth. On the other hand, the nasal cavity has fixed shape and dimensions. The soft velum controls the

air stream to the nasal cavity. A block diagram of human speech production mechanism [52] is shown below in Figure 3.

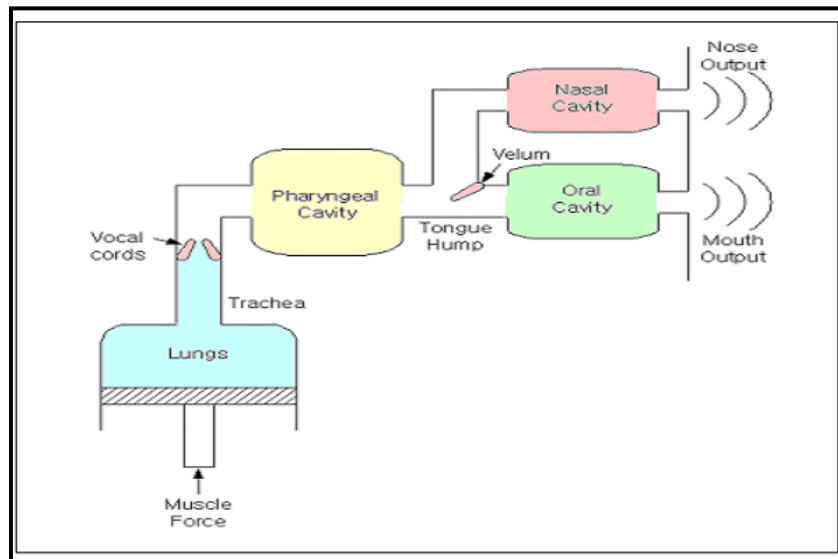

Figure 3: Block Diagram of Human Speech Production Mechanism [52]

According to Rabiner et al. [50], the lung muscles push the air out of the lungs through the trachea and the voiced speech sound is generated when the glottis or vocal cords are tensed. Under this tension, the air flow causes the glottis or vocal cords to vibrate and this produces voiced speech. On the other hand; unvoiced speech is generated when the vocal cords are relaxed, and the air flow passes through a constriction in the vocal tract and thus becomes turbulent. As a result, voiced speech sounds are generated by vocal cord vibrations and the unvoiced speech sounds are generated by air turbulence. The following figure shows the distinction between voiced and unvoiced speech.

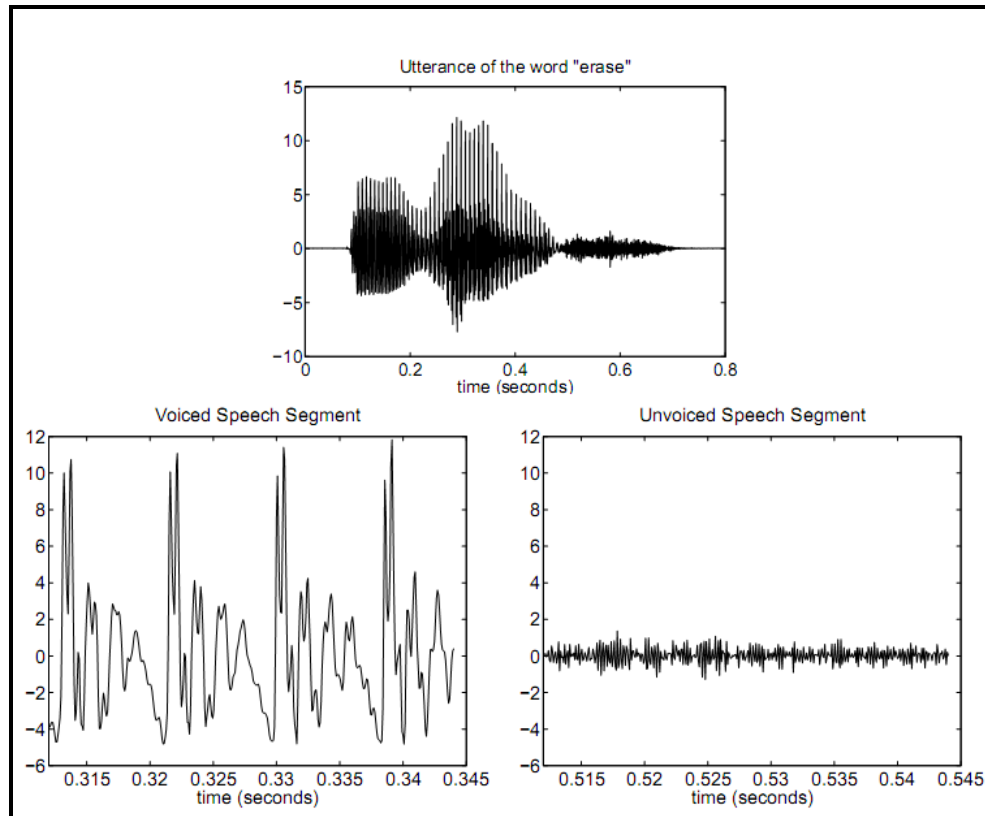

Figure 4: Distinction between Voiced and Unvoiced Speech

Voiced sounds are produced when the lungs force air through the epiglottis, the vocal cords vibrate and they interrupt the air stream and produce a quasi-periodic pressure wave. This quasi-periodic pressure wave results in a quasi-periodic nature in the time domain and harmonic structure in the frequency domain. Two different human speech production system diagrams, which show voiced and unvoiced sound distinctions, are shown below.

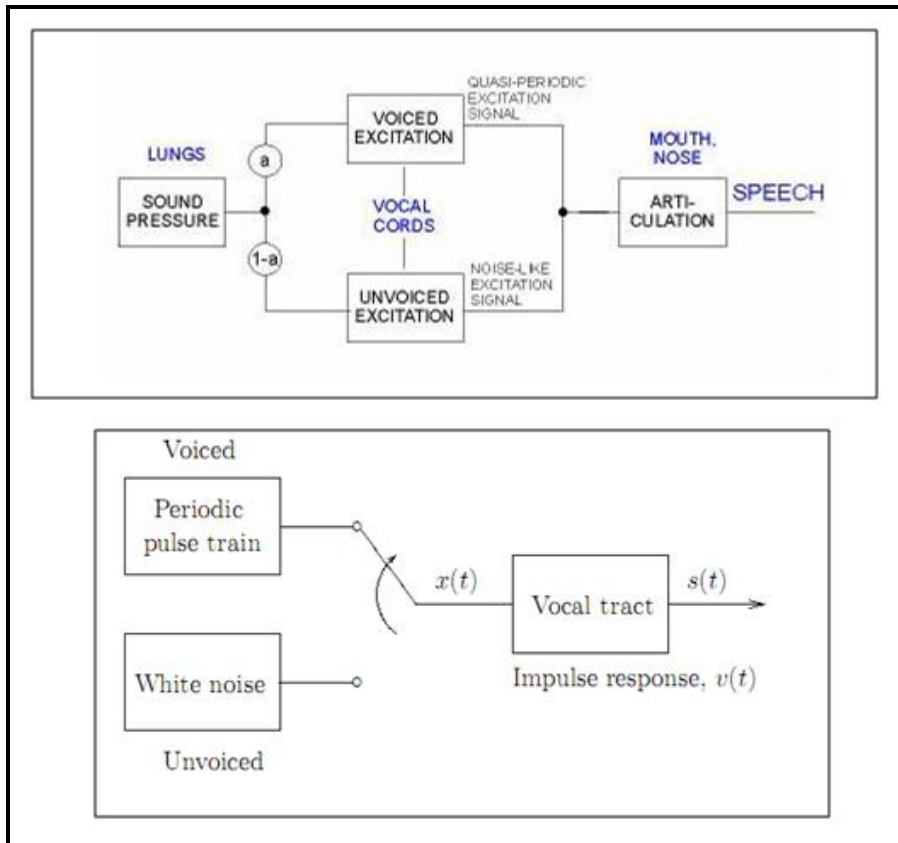

Figure 5: Human Speech Production System with Voiced and Unvoiced Sound Distinction

The speech production mechanism may be divided into three different major systems. These systems are the respiratory system, laryngeal system, and articulatory system. These systems are shown in Figure 6 below.

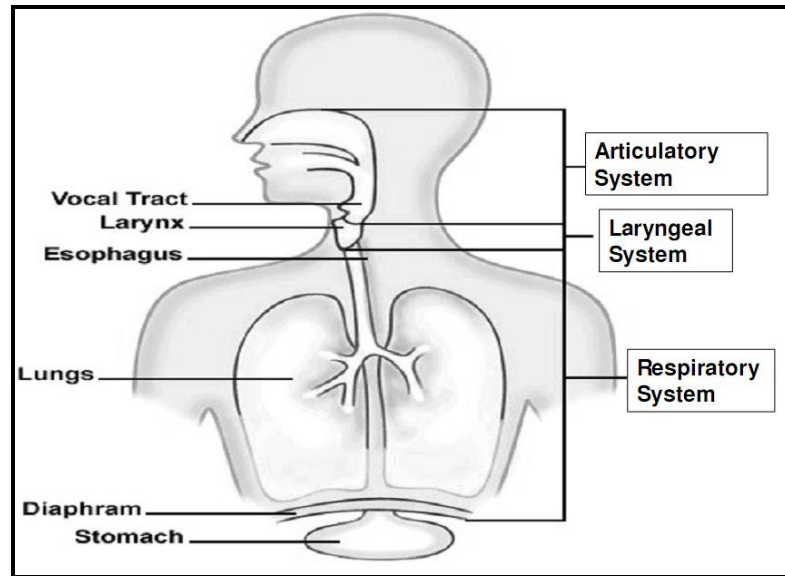

Figure 6: Major Systems of Human Speech Production Mechanism

The respiratory system is the power supply of the human speech production mechanism. It provides the air flow and pressure which will go into the larynx. The laryngeal system is the sound generator of the human speech production mechanism. The source of most speech comes about from the larynx where vocal folds can partially or completely block the airflow from the lungs. The articulatory system is the sound modifier of the human speech production mechanism since the sound is produced according to changes depending on the position, shape and movement of the articulators. The articulatory system is composed of a series cavities, muscles, bones and teeth. The vocal tract is the place where speech articulation occurs. It has three cavities which are the nasal cavity, oral cavity, and pharyngeal cavity. Figure 7 shows the human vocal tract.

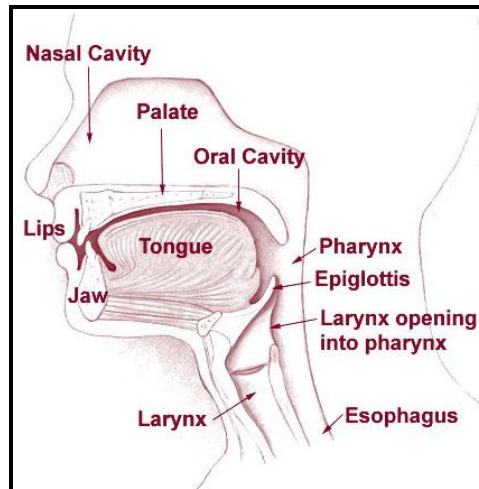

Figure 7: Human Vocal Tract

The structures involved in the articulation of speech can be classified into two categories: movable articulators and fixed articulators. The movable articulators are the lips, tongue, soft palate (velum), pharynx, lower jaw, and uvula. The fixed articulators are the hard palate, alveolar ridge, and teeth.

The three systems of speech production (respiratory system, laryngeal system, and articulatory system) are controlled via the nervous system. It is the control system of the human speech production mechanism. When the nervous system is compromised due to developmental abnormalities, acquired damage, or illness, communication is also compromised. The nervous system is essentially divided into two parts: Central Nervous System (CNS) and Peripheral Nervous System (PNS). The Central Nervous System (CNS) consists of the brain, brainstem, and spinal cord. The remaining nerves which lie outside the brain, brainstem, and spinal cord are part of the Peripheral Nervous System

(PNS). The Peripheral Nervous System connects the brain to the outside world. Damage to the PNS and CNS can affect speech and hearing ability.

2 Model of the Human Speech Production Mechanism

The human speech production mechanism can be modeled by a linear source-filter model. Figure 8 shows a block diagram of the discrete time model of the human speech production model. The impulse train generator, glottal pulse model and random noise generator are the “source” part of the model and the vocal tract model and radiation model are the “filter” part of this source-filter model. In this model, speech is described to be the convolution of an excitation source with a linear time-varying system which represents the vocal tract and radiation models. Figure 9 shows another representation of the source-filter model and corresponding spectra.

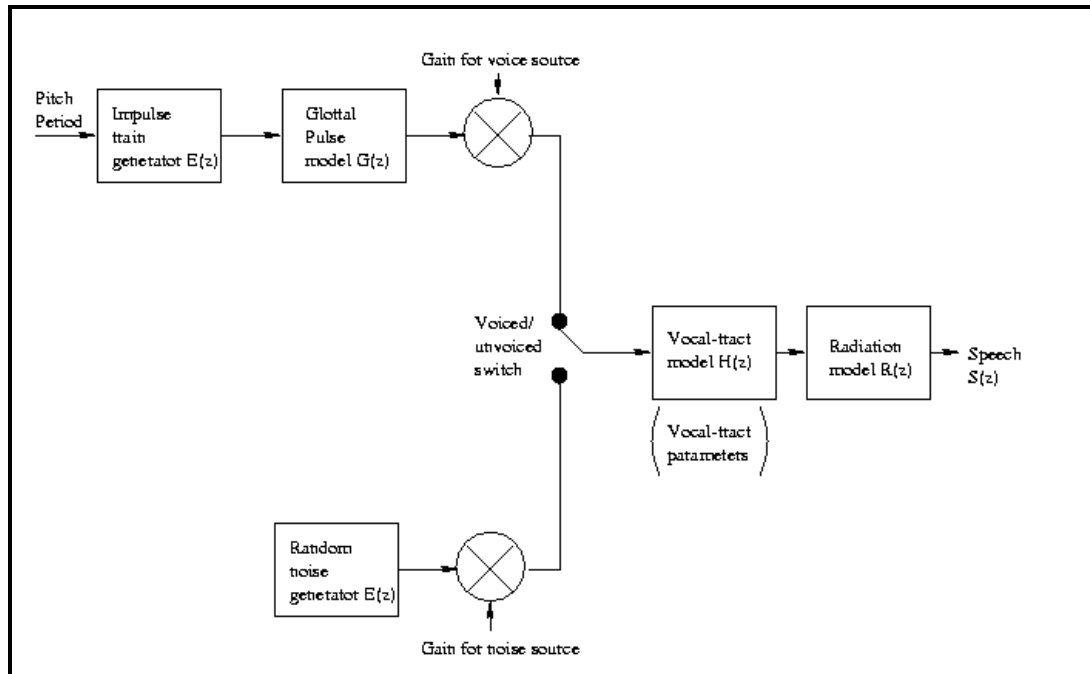

Figure 8: Block Diagram Representation of Discrete Time Model of the Human Speech Production Mechanism

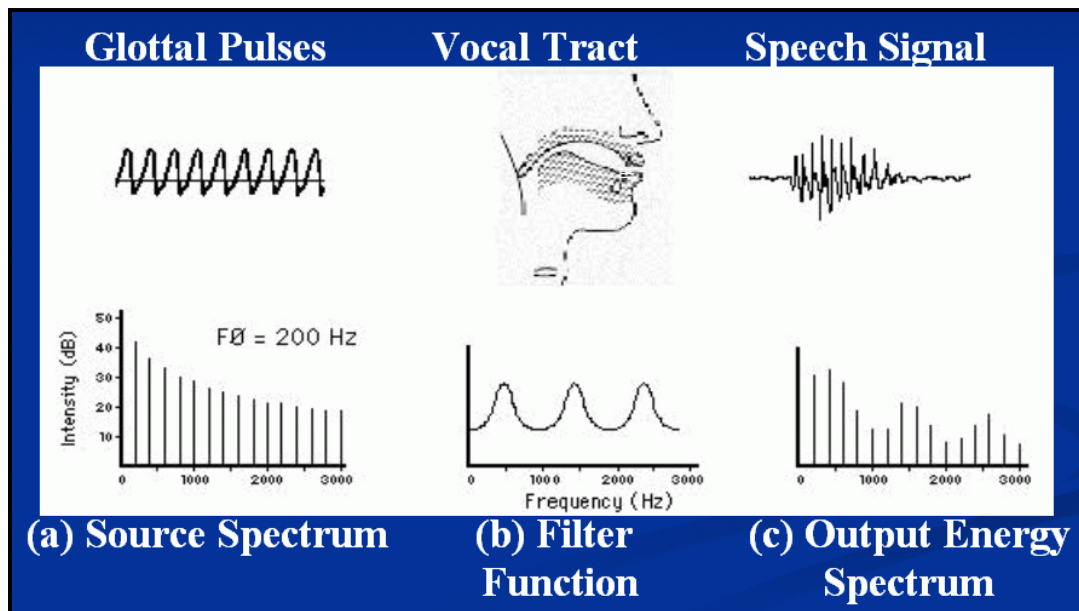

Figure 9: Source- Filter Model and Corresponding Spectra

The source-filter model can be formulated by the following formula in the z-domain:

$$S(z) = G(z) H(z) R(z) \quad (\text{Equation 1})$$

In this equation, the following are the parameters:

$S(z) \rightarrow$ Speech signal (in z-domain)

$G(z) \rightarrow$ Glottal Pulse Model (in z-domain)

$H(z) \rightarrow$ Vocal Tract Model (in z-domain)

$R(z) \rightarrow$ Radiation Model (in z-domain)

This model and equation assumes that the entire system is linear and the excitation part is separable from the vocal tract part and radiation part of the system. It is assumed that the system is short time stationary (although it is non-stationary) since the vocal tract articulators move slowly in comparison to the speech. This assumption assures that vocal tract and excitation properties are fixed for a short period of time.

2.1 Excitation Model

The excitation is modeled as a source that produces a signal which is either a train of glottal pulses for voiced speech or random noise for unvoiced speech as shown inside the red box below in Figure 10. In this model, excitation is simulated by the pulse train generator for voiced speech and by the random noise generator for unvoiced speech.

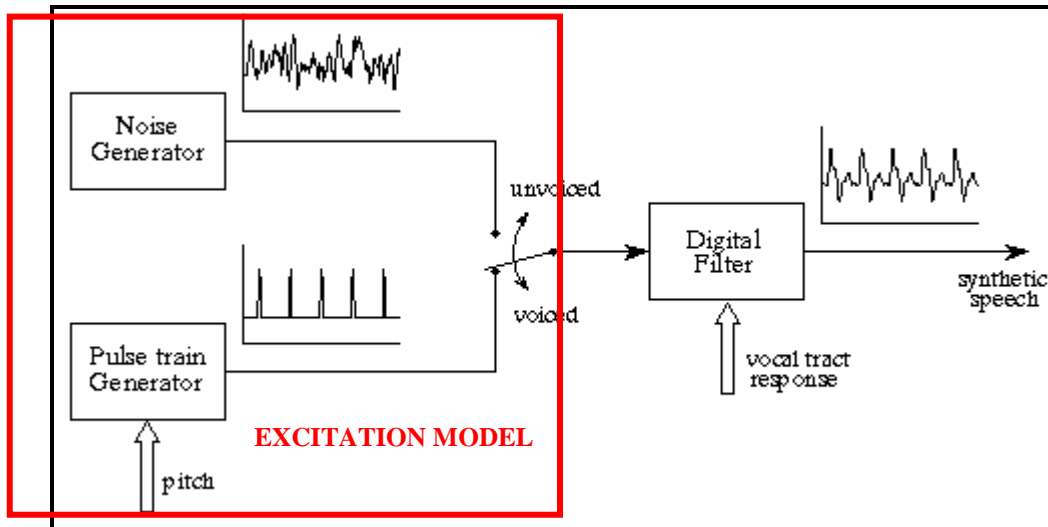

Figure 10: Excitation Model of the Human Speech Production

2.2 Vocal Tract Model

A schematic longitudinal cross sectional sketch of the human vocal tract mechanism is shown below in Figure 11. This diagram emphasizes the essential physical features of human anatomy which enter into the final stages of the speech production process. It shows the vocal tract as a tube of non-uniform cross sectional area which is bounded by vocal cords at one end and by the mouth opening at the other end. This tube serves as an acoustic transmission system for sounds generated inside the vocal tract. Although the actual human vocal tract is not a straight line like the one shown in the Figure 10, this type of model is a reasonable approximation for the wavelengths of the sounds in human speech.

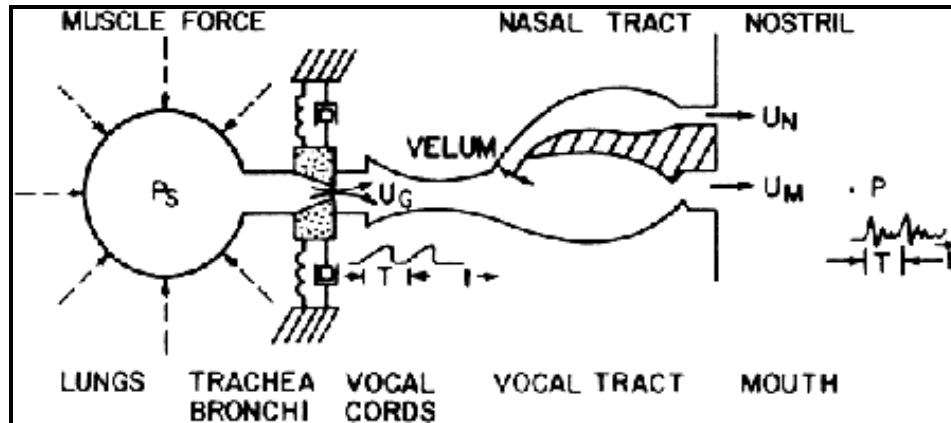

Figure 11: Schematic Model of the Human Vocal Tract System [4]

A commonly used vocal tract model is the model characterized by the concatenation of lossless tubes with different cross sectional areas and lengths. This lossless tube model has a good relationship with the discrete time all pole model for the vocal tract [54].

Depending on the shape of the acoustic tube which is mainly influenced by the tongue position, a sound wave travelling through the tube will be reflected in a certain way so that interferences will generate resonances at certain frequencies. These resonances are called formants. Their location largely determines the speech sound that is heard.

The first step towards a digital model is in representing the tube as a series of N concatenated tubes of constant cross-sectional areas as shown in Figure 12 (b) where N equals to 8. The tubes are assumed to be of equal length Δ , and if L is the total length of the vocal tract, it can be formulized like this:

$$N \cdot \Delta = L \quad (\text{Equation 2})$$

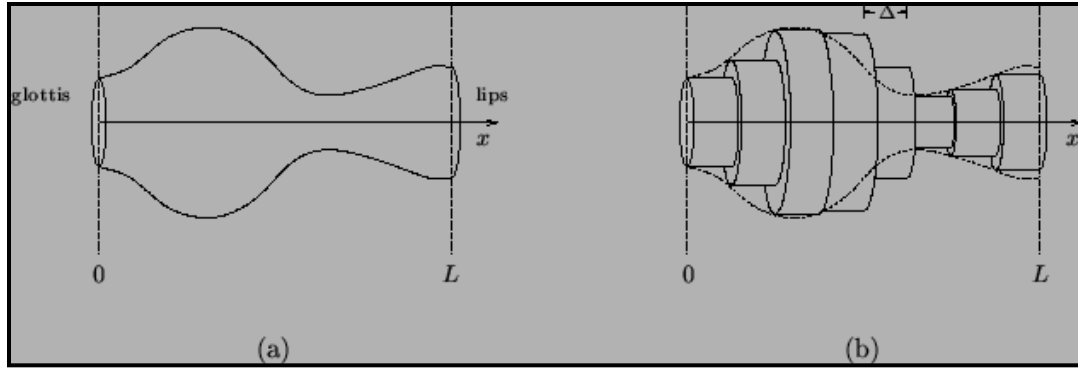

Figure 12: (a) The Vocal Tract, Modeled as a Single Dimensional Acoustic Tube of Varying Cross-Sectional Area and (b) An Eight Tube Model Suitable for Discretization

In the limit when Δ becomes small, the shape of the approximation of the series of tubes will converge to that of the continuous vocal tract as shown in Figure 12 (a). The following figure shows another representation of non-uniform acoustic tube representation of the vocal tract.

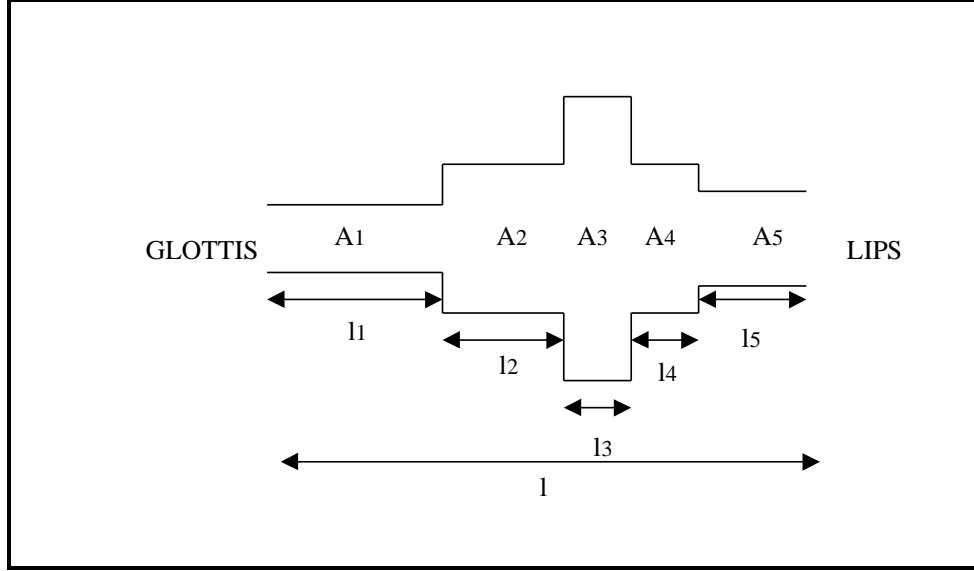

Figure 13: Non-uniform Acoustic Tube Representation of Vocal Tract with Cascading Acoustic Tubes with Different Cross-Sectional Areas

It is possible to represent the vocal-tract in a parametric form as the transfer function $H(z)$. In order to estimate the parameters of $H(z)$ from the observed speech waveform, it is necessary to assume some form for $H(z)$. Ideally, the transfer function should contain poles as well as zeros as shown in Equation 3.

$$H(z) = \frac{\sum_{k=0}^M b_k z^{-k}}{1 - \sum_{k=1}^N a_k z^{-k}} = \frac{b_0 \prod_{k=1}^M (1 - d_k z^{-1})}{\prod_{k=1}^N (1 - c_k z^{-1})}, \quad (\text{Equation 3})$$

However, if only the voiced regions of speech are used then an all-pole model for $H(z)$ is sufficient. Furthermore, linear prediction analysis can be used to efficiently estimate the parameters of an all-pole model. Finally, it can also be noted that the all-pole

model is the minimum-phase part of the true model and has an identical magnitude spectra, which contains the bulk of the speaker-dependent information.

2.3 Radiation Model

The final effect of the speech production process is radiation of sound from the lips. This part is shown below in Figure 14. As sound radiates from a source, its energy decreases. The decrease in energy is not the same for all frequencies; this effect can be modeled as a +6 dB/octave increase in energy.

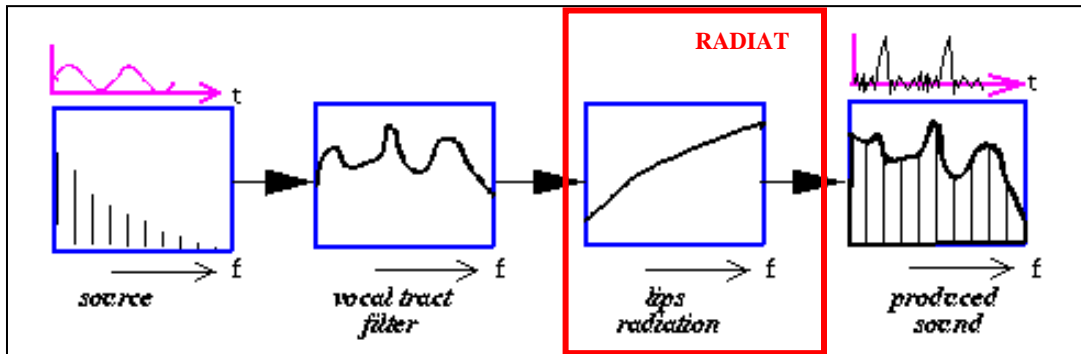

Figure 14: Radiation model part of the Human Speech Production Mechanism

Acoustic energy leaves from the vocal tract via the lips, and via the nostrils for the nasal sounds. This loss of energy from the system appears as a resistive load and in transmission line model can be represented by resistance and other frequency dependent components. An approximate model for the acoustic analysis is a circular aperture in a sphere. A circular aperture in an infinite plane is an even simpler model approach. The

infinite plane model is not too accurate, because the human head radius is about 9 cm and the human mouth radius is about 1 cm. But the infinite plane model is preferable since it yields a particularly simple electrical equivalent circuit as shown in Figure 15(a) which is composed of an inductor and a resistor in parallel. The value of the resistance in normalized ohms is 1.441. The value of the inductor depends on the radius of the aperture (represented with “a” in the figure) and it is given by “ $0.8488a/V$ ” where “V” is the velocity of sound [55]. A more complex equivalent circuit which fits the circular aperture in a sphere model has been proposed by Stevens et al. [56]. This model is shown in Figure 15 (b); it is more complicated than the other one and all the circuit element values are functions of the mouth radius.

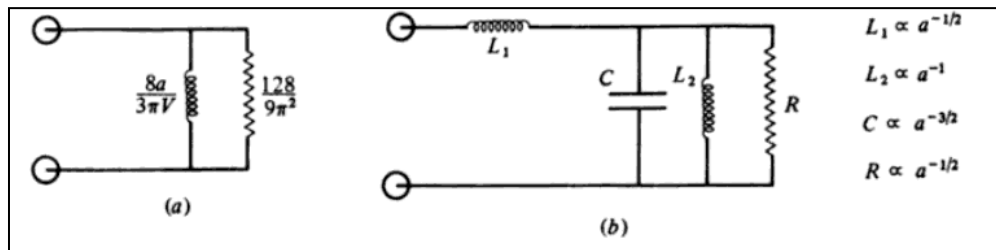

Figure 15: (a) Equivalent Circuit of Circular Orifice in an Infinite Plane
 (b) Equivalent electrical circuit of circular orifice in a Sphere.

Wong et al. [57] stated that the speech signal is related to the volume velocity at the lips through a radiation impedance $R(z)$. The sound pressure signal (for frequencies below about 4000 Hz) at a distance of l_1 from the lips is proportional to the time

derivative of un-normalized volume velocity at the lips with a time delay of l_1/c where c is equal to 35.3 cm/ms [58].

3 Physiological Effects of Emotion on Speech Production Mechanism

The laryngeal muscles, muscular activities on the respiratory organs, and different articulators coordinate the respiratory, articulatory, and phonatory processes of speech production [59]. Emotional disturbances may affect the physiological structures of speech production. The nervous system controls many muscles that coordinate the movements of speech production [58].

The sympathetic and parasympathetic divisions typically function in opposition to each other. We can think of the sympathetic division as the accelerator and the parasympathetic division as the brake. The sympathetic division typically functions in actions requiring quick responses. The parasympathetic division functions with actions that do not require immediate reaction. The main actions of the parasympathetic nervous system are summarized by the phrase "rest and digest", in contrast to the "fight-or-flight" of the sympathetic nervous system. When an emotion-producing situation affects a person, some changes happen to his/her body and these changes affect the sympathetic and parasympathetic parts of the nervous system and as result of these changes, the person's speech is influenced [60].

Increased heart rate, increased blood pressure, increased distribution of blood in the exterior muscles, changes in the rate, depth, and pattern of respiratory movements, and decrease in secretion from the salivary glands, leading to an increase in the viscosity of saliva and a drying of the mouth, tremor in muscle activity, and muscle tone increase

are the results of increased activity of the sympathetic nervous system (SNS) especially during the anger and fear emotions. On the other hand, increased activation of the parasympathetic nervous system (PNS) especially during the emotions of defeat, dejection, and grief can cause decreased heart rate, blood pressure reduction, a diversion of blood to the digestive tract and away from external muscles, and increased salivation.

So, increased activity of SNS and PNS can affect the control of respiratory, articulatory and phonatory movements that are involved in speech production and these effects can change the quality of the speech. Scherer et al. [61] observed that respiratory patterns control the vocal intensity and frequency variations and also affect the continuity and discontinuity of speech. The spectral and frequency characteristics of the glottal pulses may be affected by the modified vibratory patterns that are modified by the mass, tension, and dryness of the vocal folds. The articulation process is affected by the increased muscle tone and disturbed coordination. Excessive muscle tension produces tenseness and constriction in articulatory structures and this causes a variation in the frequency spectrum of the generated sound.

4 Effects of Depression on Speech

Depression is a mood disorder in which feelings of loss, anger, sadness, or frustration interfere with everyday life. Cavenar et al. [62] reported that the depression state was distinguishable from transient mood states with a definite pattern of behavior characterized by reduced emotional expression and physical drive. Depressed people usually have insomnia, loss of appetite and diminished sex drive. Depressed people are

emotionally disturbed by feelings of anger, guilt, desperation, loneliness and hopelessness.

Many researchers recognized speech changes associated with depression from early years such as 1892 [63], 1921 [64, 65], 1925 [66] and 1930 [67]. Research on depression has been performed since these early years. A considerable amount of research has been conducted: Moses [68] in 1954; Mahl et al. [69] and Ostwald [70] in 1964; Jones et al. [71] in 1979; Alpert [72], Darby [73] and Scherer [74] in 1981; Scherer [75] and Siegman [76] in 1987.

Depressed people's voices were described with different perceptual qualities such as monotone, lifeless, mono-loud, metallic, and dull. These qualities were linked with acoustical fluctuations in fundamental frequency, formant structure, power distribution, amplitude modulation, jitter, pause frequency and duration [59, 61, 77, 78, 79, 80, 81, 82, 83, 84, 85]. Newman et al. [86] performed a perceptual study on speech of depressed subjects. They reported that classical depression patients spoke slowly with frequent pauses and they had a narrow pitch range, low variance of pitch and a "dead" voice quality. Patients with chronic states of self-pity and dissatisfaction had a "live" voice quality with "crisp" articulation and had frequent pauses. On the other hand, manic depressive patients had a "live" voice quality with "vigorous" articulation with rapid responses and periodic pauses. Eldred et al. [87] reported results from a study that analyzed the vocal characteristics of one patient over a 13 month period of psychoanalysis. They observed that the patient had decreased pitch, volume and rate during depression periods. They also found low mean frequency for depressive speakers with respect to normal speakers' and decreased fundamental frequency. Moses [68]

analyzed the vocal characteristics of classical depressed speech and manic depressed speech. There have been many researchers who have studied discriminating among normal, depressed, and schizophrenic speech [59, 61, 77, 78, 79, 81, 82, 83, 84, 85, 88]. They used some acoustical features such as fundamental frequency, formant structure, power distribution and amplitude modulation to accomplish this discrimination.

Depression has been associated with changes in the temporal aspects of speech. There exists evidence that the people in depression speak more slowly and with longer pauses. Pinard et al. [89] reported that subjects speak more slowly during depression. This result was not validated by Darby et al. [90]. Zuberbier [91] and Weintraub et al. [92] also found that depressed subjects had a slower rate of speech. Rate of speech decreases when the speaker is in depression and this result was found by different researchers in different years; Markel et al. [93] in 1973, Natale [94] in 1977, Teasdale et al. [95] in 1979, Hinchliffe et al. [96] in 1971, Mandal et al. [97] in 1990, Newman et al. [86] in 1938, Pope et al. [98] in 1970, Weintraub et al. [92] in 1967. There is evidence that people with severe depression speak more slowly as well as speak with longer pauses. There are also many studies about pause lengthening in depression [79, 82, 92, 96, 98, 99, 100, 101, 102, 103, 104, 105, 106, 107]. Pause time was found to decrease when the patient recovers from depression [99, 100]. Greden et al. [100] also found that this decreasing pause time could be a positive clinical outcome of the treatment. There were other studies that investigated the increasing pause time during depression [91, 92, 102, 108, 109, 110]. Ranelli et al. [111] observed that depressed patients who have long pauses during their spontaneous speech gave better results after medication. Ellgring et al. [112] reported that the decrease in pause duration and increase in speech rate were

found to be good indicators of recovering from depression after treatment. Szabadi et al.[99], Greden et al. [100], Greden et al. [108], Godfrey et al. [109], Hardy et al. [110], Hoffmann et al. [102], Ghazlan et al. [113], and Teasdale et al. [107] worked on the pause time of depressed voices in non-spontaneous speech. They analyzed the speech of patients counting from 1 to 10 and found that pause time was longer for depressed people than for people who were hospitalized from depression. Bouhuys et al. [114] derived similar conclusions found by Teasdale et al. [107]. Szabadi et al. [99] and Hoffmann et al. [102] reported that pause times were substantially shorter for medicated depressed patients in comparison to unmedicated depressed patients. The pause time drastically decreased after medication. Natale [94] investigated the relationship between mood states and response times, speech rates, and pause frequencies using 45 college females' speeches. Silent pauses were reported to be positively related to depression. Brenitz [79] reported that depressed females spoke with longer pauses than healthy females.

Depression and sadness causes the speech rate and loudness to decrease [76, 115, 116, 117]. On the other hand, some researchers reported an increasing rate of speech during depression [82, 92, 118, 96]. According to Siegman [76], speech rate was an excellent predictor for mood changes in clinical depression. Darby et al. [101] investigated the relationship between expressive vocal behavior (especially speech rate and loudness), and depression, fear, anxiety, and sadness. Subjects spoke about events which were sad or depressing and neutral. They used three different voice styles, which were: fast and loud, normal, and slow and soft. The highest levels of subjective affective and cardiovascular arousal occurred when patients spoke in a slow and soft voice style in the case of sadness or depression. Sobin et al. [119] worked on automatic speech

(reading) and investigated four parameters that were different for sadness other than three emotions (anger, fear and joy). According to their study; when the speaker was sad, their voice was less loud, less inflected, had more pauses and a slower rate. Weintraub et al. [92] studied 46 normal controls and 45 depressed patients and observed that depressed subjects had longer silences, fewer words, and a lower word rate than the control subjects. Alpert et al. [120] examined many measures (such as amplitude, rate, pausing, and inflection) of 22 elderly depressed patients and 19 elderly normal subjects for characterizing sadness. They divided the depressed patients into two groups, agitated and retarded depressed patients. As a result, they reported that depressed speech had less prosody (emphasis and inflection) than normal speech. Agitated depressed patients showed an improvement in the utterance and retarded depressed patients showed an improvement in pause measures after a 12-week double blind medicine treatment. Mean speaking intensity and loudness range was observed to be correlated with depression according to Darby and Hollien [90], Darby and Simmons [121], and Ostwald [122].

The power distribution of speech was found to be another feature affected by depression [59, 77, 104, 123, 124, 125, 126]. Ostwald [124], Hargreaves et al. [123], Ostwald [122], Roessler et al.[84], Scherer [59], and Tolkmitt et al. [77] observed that the depressed patients' speech have more power at frequencies above 500 Hz. After the patients were treated, their speeches have more power at lower frequencies, so the power distribution shifts to a lower frequency range [77, 123, 124, 126]. On the other hand, and Kuny et al. [104] and Hargreaves et al. [125] reported a greater increase in higher formants after depression treatment. In another study, Hargreaves et al. [122] analyzed

the power spectrum of thirty two depressed subjects' voices. They found twenty five patients' voice spectrum significantly correlated with mood ratings.

Fundamental frequency is another important feature that has been studied by different researchers. Some key statistics of the fundamental frequency that were correlated with depression were found be range, mean, contour, variance and kurtosis [59, 78, 79, 81, 82, 83, 84, 101, 104, 121, 127, 128]. Nilsonne [82], Kuny et al. [104], and Nilsonne et al. [127] found that dynamic range of fundamental frequency variation increased after depression treatment. France [126] and Nilsonne [129] observed that depressed subjects had dynamically lower fundamental frequency range when they were compared with control subjects. Nilsonne et al. [130] found that listeners can differentiate between the depressed patients and patients after the recovery from the fundamental frequency contour. Askenfelt et al. [131] reported the rate of fundamental frequency change is relevant to depression. Leff et al. [81] reported a narrow pitch range for the retarded depressed patients. On the other hand, Darby et al. [90] found that recovering from depression didn't change the standard deviation of the fundamental frequency distribution. In another study, Nilsonne et al. [127] used seven different fundamental frequency parameters on synthetic speech and on voice recordings of depressed people during depression and after improvement. These parameters were the average rate of change of the fundamental frequency, its standard deviation, the absolute rate of fundamental frequency change, the total reading time, the percent pause time of the total reading time, the mean and the standard deviation of the fundamental frequency distribution. They discovered the standard deviation of the rate of fundamental frequency change and the mean absolute rate of fundamental frequency change correlated with

clinical depression. Additionally, standard deviation of fundamental frequency and relative occurrence of silent intervals indicated a covariation with mental state. Nilsonne [129] studied the distribution of fundamental frequency measures, and different measures of speech pause time and speech rate times on a database composed of 17 female depressed patients, 11 male depressed patients, 7 female, and 6 male healthy control subjects. According to this study, the fundamental frequency changeability measures were found to be lower for the depressed subjects and the pauses between the interviewer's questions and subjects' answers were found to be longer for the depressed group. He also compared male and female patients and found that the standard deviation of fundamental frequency was higher for female subjects. Voice pitch changes for depressed patients were also reported by Darby et al. [90, 101]. Nilsonne [82] found that the rate of change of fundamental frequency is lower during depression than after recovery. She analyzed sixteen depressed patients during depression and after clinical improvement while they were reading. The following are the features that correlate with the clinical state of the depressed patients: the standard deviation of the voice fundamental frequency distribution, the percent pause time, the standard deviation of the rate of change of the voice fundamental frequency, and average speed of voice change. Fundamental frequency mean, total reading time, and average rate of change of the voice fundamental frequency changed after the treatment. The standard deviation of the voice fundamental frequency and the standard deviation of the rate of change of the voice fundamental frequency increased after treatment. The studies that were conducted by Nilsonne in [82, 127, 129] gave consistent results. Fundamental frequency variation increased after depression treatment [82, 127] and in another study of Nilsonne [129]

depressed subjects' fundamental frequency had lower dynamic range than healthy subjects'. Brenitz [79] had a similar result. Brenitz [79] analyzed eleven depressed female and eleven healthy female speeches while they were discussing topics in four categories (sad, angry, positive, neutral). The average fundamental frequency, the range of fundamental frequency, maximum and minimum pitch and temporal pacing were evaluated. The healthy females spoke with a wide range of fundamental frequency, and the average fundamental frequency of their voices changed according to speech content. On the other hand, depressed females spoke with a narrow range of fundamental frequency, and the average fundamental frequency of their voices didn't change with the content of their speech.

Many other researchers studied the fundamental frequency's relationship to the clinical state of depression. Bannister [78], Eldred et al. [87], Moses [68], and Roessler et al. [132] reported a low mean fundamental frequency for depressive speakers when they were compared with normal speakers' and decreased fundamental frequency. However, Whitman et al. [128] observed that during severe depression the fundamental frequency increases. Some researchers studied the vocal changes of depressed patients after therapy. Askenfelt et al. [131], Kuny et al. [104], Tolkmitt et al. [77], and Scherer [59] reported fundamental frequency decrease after therapy, but Hargreaves et al. [133] found an increase and Stassen et al. [105] couldn't find a significant effect on fundamental frequency after therapy. This disagreement could be as a result of different phases of the patients such as manic and depressive phases or the differential gender effects with respect to voice quality [112]. When the short term fundamental frequency changes are analyzed, most of the studies show that there exists a narrow range and restricted

variability in depressive speech [70, 78, 86, 91, 118]. On the other hand, Fleischmann [134], and Heitman [135] observed wide fundamental frequency range and variability in depressive speech. Kuny et al. [104], Nilsonne [82], Stassen et al. [105] investigated widened fundamental frequency range and increased variability that after successful therapy. Kuny et al. [104] also observed that there exists a negative correlation between psychopathology and fundamental frequency 6 dB bandwidth. They also observed fundamental frequency, fundamental frequency amplitude and fundamental frequency contour positively correlated with psychopathology. They analyzed thirty depressed patients and analysis showed that fundamental frequency amplitude, fundamental frequency 6 – dB bandwidth and fundamental frequency contour were highly correlated with depression. As described in Section 3.1, Tolkmitt et al. [77] examined seventeen depressive patients' voices. Depressive patients' fundamental frequencies decreased and their voices become more relaxed after treatment.

Ozdas et al. [136] evaluated depressed patients', high risk near-term suicidal patients' and control group's speeches and investigated glottal flow spectrum slope and vocal jitter features for classifying each of them. Vocal jitter is a measure of short-time fluctuations in the fundamental frequency. The results showed that depressed patients' and near-term suicidal risk patients' speech had higher vocal jitter values than control group speech. The slope of the glottal flow spectrum was found to be a significant discriminating feature for all groups. Depressed patients' average glottal spectral slope values gave results which were lower than those of the control group or near-term suicidal group. The jitter-based ML classifier was not a good discriminator between depressed and control classes with 65% accuracy. However, a spectral slope-based ML

classifier gave a discrimination result with 90% accuracy between depressed and control classes. A maximum likelihood classifier which was developed by combining the a posteriori probabilities gave 90% classification score between depressed patients and control group. Ozdas et al. [136] also reported that depressed and near-term suicidal patients had higher energies in the upper part of the frequency bands of the glottal flow spectrum as compared with the control groups'.

Moore et al. studied speech in clinical depression and published three conference papers [137, 138, 139]. In the first paper [137], they analyzed the prosodic variation in depressed speech. They collected fundamental frequency, energy and speaking rate features from 15 depressed (9 female, 6 male) and 18 control (9 female, 9 male) subjects. The fundamental frequency measures periodic rate of glottal opening and closing during voiced sections of speech. The energy contour of the speech signal measures the intensity of the speech over time and they used two categories of energy contour statistics: energy deviation statistics (EDS) and energy median statistics (EMS). They measured speaking rate in words per second and syllables per second. The results show that speaking rate and energy didn't separate depressed male subjects from control male subjects. But several fundamental frequency feature statistics showed a good separation between them. Speaking rate statistics didn't separate depressed female subjects from control female subjects. Fundamental frequency statistics and energy related statistics, particularly EMS, showed a good separation for female subjects [137]. In their second paper, Moore et al. [138] investigated glottal features (amplitude shimmer, timing, ratios, and spectral characteristics of glottal waveform) that could be used to classify clinical depression. Glottal ratios and spectral characteristics were found to be the best features that could be

used to classify male depressed subjects from male control subjects. Spectral characteristics and features that were related to total cycle and closed phase were the ones that could be used to classify female depressed subjects from female control subjects [138]. A third paper [139] was the continuation of the previous two papers [137, 138]. In this paper, they compared the clustering separation of observations representing glottal based and prosodic based feature categories of speech in relation to clinical depression and they identified optimal classifiers. The results for male subjects showed that glottal ratio/spectrum gave the best statistical separation. Formant and glottal ratio/spectrum subcategories were the best subcategories of clustering. The results for female subjects showed that no single subcategory displayed the best within group accuracy. The glottal timing classifier, glottal ratio/spectrum classifier and formant bandwidth classifier were the best three classifiers. Finally, Moore et al. [140] published a journal paper in which they analyzed features related to prosodics, vocal tract and glottal waveform and they tried to find the impact of glottal source features in clinical depression speech analysis. They extracted 200 prosodic, vocal tract and glottal waveform measures and they translated this information into 2000 statistics. They analyzed the discrimination power of depressed speech with different feature combinations. These combinations were prosodic measures alone, prosodic and vocal tract measures, prosodic and glottal measures, and all three feature sets. The results were better when the prosodic feature set was combined with the glottal domain features instead of vocal tract domain features for both females and males. Therefore, it could be concluded that glottal domain features are stronger discriminators than vocal tract domain features when combined with prosodic information. On the other hand, vocal tract domain features are potentially more useful

for experiments based on smaller observational times. Male depressed patients showed greater anxiety during the experiment, and as a consequence of this, they had higher energy measures than the control group. But for females, it is the opposite. Female depressed patients showed lower energy measures than female control group. Glottal features like GLS (glottal spectrum), GLR (glottal ratios), and GLT (glottal timing) were found to be the most widely used features in creating training and testing classifiers.

There exists a strong link between muscle tension and fundamental frequency. According to Scherer [75], Goldstein [141], Scherer [142], Greden et al. [143]; depressive mood causes the muscle tone to be elevated which will increase fundamental frequency and decrease the range and variability of fundamental frequency since the phonation mechanism rigidity increases when the muscle is under high tension.

Some researchers [59, 73, 144] reported that depressed people speak with reduced articulatory precision due to speaking with a less constricted vocal tract, such as less articulatory effort [145]. This characteristic of depressed speech was found by Tolkmitt et al. [77]. They studied formant analysis of depressed speech and observed that the first formant frequency increased significantly after treatment. According to their study, before depression treatment the patients have neutral formant frequencies such as 500 Hz, 1500 Hz, and 2500 Hz. These frequencies were typically generated during the resting position of the vocal tract like the uniform cylinder [146]. Given that patients' first formants were close to 500 Hz before treatment, the patients produced vowels with less articulatory effort. Due to the greater articulatory efforts, their vocal tract constrictions increased after treatment and their vowel formants moved to the expected values. This result was also verified by France et al. [126]. In their study, depressed subjects had

higher first formant frequencies when their frequencies were compared with normal control subjects. France et al. [126] also investigated larger first formant bandwidth and narrower second formant bandwidth in depressed speech. Flint et al. [147] reported lower second formants for major depressed patients in comparison with healthy subjects. Scherer [148] predicted that when depressed subjects were compared to normal subjects, they had increased first formant and decreased second formant.

Formant frequency bandwidths were another feature that was used for vocal quality assessment [149]. Using formant frequency bandwidths for distinguishing depressed subjects from healthy subjects was studied by France et al. [150] and France [126]. From these studies, it was observed that depressed subjects had increased first formant bandwidth and decreased second formant bandwidth when their speech was compared to normal subjects'. Hargreaves et al. [123] and Whitman et al. [128] reported that depressed patients' second and third formant center frequencies decreased during the depression state. Then their formant frequencies increased, when the patients improved from their depression state.

5 Effects of Suicidal Risk on Speech

Very few researchers have studied speech changes associated with suicidal risk; therefore there haven't been very many papers on this subject. Detecting near-term suicidal risk from paralinguistic properties of speech was introduced by Dr. Stephen Silverman and Dr. Marilyn Silverman in 1992 [151].

The first research about vocal characteristics of speech in suicidal risk was conducted by Campbell [152]. She analyzed the statistical characteristics of the

fundamental frequency of suicidal risk patient's speech. The statistical characteristics that she analyzed were kurtosis, coefficient of variation, and skewness. She only analyzed one female and two male patients when they were in a suicidal condition one time and then again when they were diagnosed as not being suicidal. Based on her linear classification analysis, a 22.7 % apparent error rate was found.

A few years later, France [126] and France et al. [150] compared the speech acoustics of control subjects and subjects who were suffering from depression, dysthymia and high-risk or near-term suicidality. Dysthymia is a chronic mood disorder that falls within the depression spectrum. It is considered a chronic depression which is less severe than major depressive disorder. France et al. [150] had 10 control subjects, 17 dysthymic patients, and 21 major depressed patients for the female sample group. They had 24 control subjects, 21 major depressed patients and 22 high-risk suicidal patients for the male sample group. Acoustical parameters of fundamental frequency, amplitude modulation, formants, and power distribution were examined on speech samples. Range, mean, variance, skewness, coefficient of variation and kurtosis were analyzed for the fundamental frequency and amplitude modulation analyses. The first three formants' frequencies and bandwidths were also analyzed. For the power distribution analysis, they approximately calculated the proportion of the total energy in four different frequency subbands which were 0 – 500 Hz, 501 – 1000 Hz, 1001 – 1500 Hz and 1501 – 2000 Hz. Multivariate feature and discriminant analyses were performed on the control, depressed, dysthymic, and high-risk suicidal classes.

Female subjects' results showed that fundamental frequency and amplitude modulation were useless as class membership discriminators. On the other hand, formant

and power spectral density features were good discriminators for distinguishing dysthymic and depressed patients from control subjects. Narrow second formant bandwidth was the feature that significantly distinguishes dysthymic patient's speech from control subject's speech. Major depressed female subjects had decreased power spectral density in the 0-500 Hz subband, increased power spectral density in 501-1000 Hz subband, decreased second formant bandwidth, decreased third formant bandwidth, and increased first formant center frequency. Formant and power spectral density features were very good discriminating features for control and major depressed patients. Simultaneous statistical analysis of dysthymic patients, major depressed patients and control group showed that the first formant center frequency, first formant bandwidth, second formant bandwidth and third formant bandwidth were significantly different among these groups [150].

When the male subjects' results were analyzed, formant and power spectral density features were found to be good discriminators for distinguishing depressed and high-risk suicidal patients from control subjects. The characteristics of depressed and high-risk suicidal patients' speech were increased formant frequencies (first, second and third), and third formant bandwidth and decreased fundamental frequency and second formant bandwidth. Amplitude modulation range and amplitude modulation skewness were also found to be significantly increased in depressed patient's speech. A significant power shift occurred from lower to higher frequency bands in high-risk suicidal patients' speech. Classifiers designed with formant and power spectral density features were more successful in classifying control subjects in control – depressed pairwise and control – suicidal pairwise analyses. A quadratic classifier designed from amplitude modulation

coefficient of variation, amplitude modulation range, and power spectral density between 1001-1500 Hz gave classification of 86 % for depressed speech and 77% for suicidal speech. Amplitude modulation skewness, first formant frequency center, third formant frequency center, and second power spectral density were used to create an integrated quadratic discriminant function for all three classes and this function classified all classes with good percentages (high-risk suicidal 75%, major depressed 71% and control 75%) [150].

In summary, the formant features and power spectral density features were the best class discriminators for both of the subject groups [150]. For the male subjects, AM features were also a strong class discriminator. On the other hand, fundamental frequency features were found to be ineffective class discriminators for both of the subject groups. More detailed information about this research can be found in [126].

Ozdas et al. [136, 153, 154] and Ozdas [155] also worked on suicidal speech. Ozdas et al. [153] analyzed jitter as a discriminator between suicidal and non-suicidal patients. Vocal jitter is a measure of short-time fluctuations in the fundamental frequency. They evaluated the speech of 10 male near-term suicidal patients and 10 male healthy control subjects. Increased short term fundamental frequency fluctuation was observed in the near-term suicidal speech. They observed these fundamental frequency perturbations differ significantly between near-term suicidal patients' speech and control subjects' speech. A holdout maximum likelihood classifier was used and 80% classification correctness was achieved using mean jitter values extracted from each subject.

Ozdas et al. [136] studied high risk near-term suicidal patients', depressed patients' and control group's speeches. They investigated the discriminating power of

vocal jitter and glottal flow spectrum slope features. The results showed that the speech samples from near-term suicidal risk patients and depressed patients had higher vocal jitter values than control group speech samples. Some researchers [156, 157] have reported that there exists a negative correlation between mean jitter values and mean fundamental frequency levels. Therefore, suicidal and depressed speech had lower fundamental frequencies and higher jitter values as a result of psychomotor retardation [156, 157]. This result was confirmed in the study conducted by Ozdas et al. [136]. The majority of the studies showed that depression causes reduced variations in long term fundamental frequency while it causes increased variations in short term. In this study, depressed patients had average jitter values that were higher than the control groups' but there were no statistically significant differences when they were compared with the control group and suicidal risk group. The slope of the glottal flow spectrum was found to be a significant discriminator between all three subject groups. Depressed patients' average glottal spectral slope values were found to be lower than those of the control group or near-term suicidal group. The class variances for vocal jitter were found to be significantly different for suicidal and depressed groups when they were compared to the control group using an F-Test. But there were no significant differences between the suicidal and depressed groups using an F-Test. Applying two sample T-tests, class means were significantly different between suicidal and control classes for vocal jitter. For spectral slope measurements, class means were significantly different for all class comparisons. The jitter-based ML classifier was a good discriminator between suicidal and control classes with 80% accuracy, but it gave only 60% discrimination accuracy between suicidal and depressed classes and 65% discrimination accuracy between

depressed and control classes. In contrast, the spectral slope-based ML classifier gave 75% discrimination accuracy between suicidal and depressed classes, and 90% discrimination accuracy between control and depressed classes. However, it didn't give good discrimination performance (60%) between the suicidal and control classes. A maximum likelihood classifier which was developed by combining the a posteriori probabilities gave 85% classification score between the suicidal and control groups, 75% classification score between the suicidal and depressed groups, and 90% classification score between the depressed and control groups. Ozdas et al. [136] also found that near-term suicidal patients and depressed patients had higher energies in the upper part of the frequency bands of the glottal flow spectrum when compared with the control groups'. Similar energy shifts that occurred in long term energy spectra were also observed by other researchers [59, 77, 84, 122, 124, 150].

Ozdas et al. [154] studied lower order mel cepstral coefficients to discriminate suicidal patients from depressed and control patients. They had 10 near-term suicidal patients, 10 major depressed patients and 10 non-depressed control patients. Unimodal Gaussian models with 4, 8, and 12 features, and Gaussian Mixture Models (GMM) with 2, 4, 6, and 8 component densities were developed to classify each class' pattern and checked which model gave better classification results. The model of the first four mel-cepstral coefficients with GMM using 6 component densities gave the best classification result. The univariate Gaussian also gave better results with four features. Overall correct classification of 78.3% was achieved using GMM with a maximum likelihood classifier. More detailed information about the research that Ozdas conducted may be found in [155].

Kaymaz Keskinpala et al. [211] studied lower order mel cepstral coefficients and energy in frequency bands to discriminate suicidal patients from depressed and remitted patients. Unimodal Gaussian models with 4 and 8 features were used to screen for high risk suicidal states. In this study, the univariate Gaussian gave better results with eight features.

In [212], Kaymaz Keskinpala et al. studied mel-frequency cepstrum coefficients for distinguishing high risk suicidal subjects among depressed subjects using cross validation technique. It was found that mel-frequency cepstrum coefficients discriminated among the depressed patients, with matching of the vocal to clinical assessment with a performance better than 70%.

In recent years, Yingthawornsuk et al. [158] analyzed the speech of 10 male high risk suicidal patients, 13 male depressed patients and 9 male remitted patients. Audio recordings were gathered during clinical interviews (interview session) and while patients were reading a standardized text (reading session). They performed power distribution analysis on the speech data. They obtained power spectral densities between 0 – 2000 Hz with four different frequency ranges of 500 Hz; they also obtained peak power values and the frequency of the peak power. The results showed that suicidal speech had a significantly lower peak location frequency when compared with the remitted speech in both interview and reading sessions. For both sessions, depressed patients' speech had higher power spectral density between 0-500 Hz and power spectral density between 1000 – 1500 Hz and lower power spectral density between 500-1000 Hz when they were compared with remitted patients' speech. When suicidal patients' speech and remitted patients' speech were compared, it was found that power spectral density between 0-500

Hz was reduced for remitted speech whereas it was increased between 500 – 1000 Hz and 1000 – 1500 Hz during the interview session. The same results were obtained during the reading session except for an increase between 1000 – 1500 Hz. Suicidal patients were distinguished from depressed patients with 77% accuracy, suicidal patients were distinguished from remitted patients with 85% accuracy and depressed patients were distinguished from remitted patients with 94% accuracy during the interview session. For the reading session, suicidal patients were discriminated from depressed patients with 82% accuracy, suicidal patients were discriminated from remitted patients with 75% accuracy and depressed patients were discriminated from remitted patients with 73% accuracy [158].

Yingthawornsuk et al. [159] studied spectral energy features and features that represent the vocal tract system characteristics to distinguish suicidal patients from depressed patients. Their study was composed of 10 female suicidal patients and 10 female depressed patients and they collected data during interviews (text-independent speech) and while subjects were reading a predetermined part of a book (text-dependent speech). In this study, they estimated the smoothed magnitude spectrum of the vocal tract system using cepstrum analysis and a Gaussian mixture model. They extracted acoustic features in terms of GMM estimates (center frequency, bandwidth, weight coefficient) after fitting the GMM to the magnitude spectrum. They also analyzed power spectral density (PSD) in four different frequency sub-bands of 0 – 500 Hz, 500 – 1000 Hz, 1000 – 1500 Hz, and 1500 – 2000 Hz. The results show that PSD between 0 – 500 Hz, PSD between 500 – 1000 Hz, second center frequency, and second bandwidth were found to be best feature set for good discrimination between suicidal and depressed speakers with

85.75% accuracy for text-independent speech. For text-dependent speech, PSD between 0 – 500 Hz, PSD between 500 – 1000 Hz, second center frequency were found to be the best the discriminator features with 90.33% accuracy. More detailed information about the research that Yingthawornsuk conducted can be found in [160].

6 Significance

Suicide is a major, preventable public health problem. In 2007, suicide was the tenth leading cause of death in the United States accounting for 34,598 deaths [10]. The overall death rate was 11.3 suicide deaths per 100,000 people [10]. An estimated 11 attempted suicides occur per every suicide death [10]. Research shows that risk factors for suicide include depression and other mental disorders. More than 90% of people who die by suicide have these risk factors [8]. Research shows that older adults and women who die by suicide are likely to have seen a primary care provider in the year before death [16]. So, improving primary care provider's ability to recognize and treat risk factors may help prevent suicide among these groups [16]. In another research, it is reported that 55 – 59 % percent of consecutive depressed suicide victims [37, 43,44] and 41 – 73% of consecutive suicide victims [45, 18] contact different levels of the health care system (mostly general practitioners) several days, weeks or months before their deaths. Thus, better recognition of suicide risk and more appropriate treatment of depression are very important in suicide prevention. This research could be very useful in helping with development of a diagnostic tool that can assess the risk of committing suicide. Such a tool would enable general practitioners to evaluate the risk of suicide. Furthermore, when people who are suicidal visit a physician's office or emergency room

because of another illness, such a diagnostic tool would help with screening of such patients. Finally, this diagnostic tool could complement psychiatrists' existing tools and techniques in evaluating the suicidal risk of their patients.

CHAPTER III

OBJECTIVE ESTIMATION OF SUICIDAL RISK USING MEL-FREQUENCY CEPSTRAL COEFFICIENTS

Abstract

Depression is a common mental disorder which causes human suffering and huge costs for society. Depression can lead to suicidal behavior. It is very important to realize that depression is a treatable disorder and suicide is a preventable act. It is very important to evaluate a patient's psychological state and to evaluate a depressed patient's risk of committing suicide, since suicide may be prevented by psychiatric help. The aim of this research is estimating the suicidal risk using mel-frequency cepstral coefficients (MFCCs) with high classification rates and the results show that the MFCCs are useful indicators for DP-HR discrimination.

Different numbers of MFCCs (4, 8, 12, 16, and 20) are used to discriminate high risk suicidal patients from depressed patients with and without environmental compensation and with different classifiers (the linear and the quadratic). For all, the DP individual performance, the HR individual performance and the DP-HR pairwise group performances of the female interview and the female reading sessions, the uncompensated results which are analyzed with the quadratic classifier yield the best combination to get high classification results. For all, the HR individual performances and the DP-HR pairwise group performances of the male interview and the male reading sessions, the uncompensated quadratic classifier and the uncompensated linear classifier are the best combinations to get high classification results. For all, the DP individual

performances of the male interview and the male reading sessions, the uncompensated quadratic classifier is the best combination to get high classification results for all MFCCs except for 4 MFCCs. The compensated quadratic is the best one for 4 MFCCs.

A different approach is proposed to maximize the classification rates of discriminating the high risk suicidal patients from the depressed patients using fewer coefficients. According to this approach, an optimal set of MFCCs are found using a cross validation technique. For the DP-HR total classification performance of the male patients, the reading session (78.00%) is slightly better than the interview session (75.20%). For the DP-HR total classification performance of the female patients, the interview session (66.40%) is slightly better than the reading session (63.90%). The DP-HR total classification rates were better with the male patients.

1 Introduction

Suicide is a serious public health problem and it may be prevented by psychiatric help. Therefore it is very important to evaluate a patient's risk of committing suicide when a patient is seen by a psychiatrist. Some research has showed that it is possible to distinguish the high risk suicidal patients from the depressed patients and the control group using the mel-frequency cepstral coefficients. Ozdas [155] studied lower order mel-frequency cepstral coefficients to discriminate suicidal patients from depressed and control patients. Ozdas's research [155] has laid the foundation for further research. The mel-frequency cepstral coefficients were analyzed without female patients' data in Ozdas's study [155]. The research in this dissertation covers both male and female speech

data. Another issue is the size of the patient database. Ozdas [155] had limited data, only 10 near-term suicidal patients, 10 major depressed patients and 10 non-depressed control patients. The number of the patients is increased for this research. This proposed research is also improved on the previous study through greater control of the recording environment. In Ozdas's research [155], the database was composed of recordings of suicide notes left on tapes, and interviews of patients who attempted suicide but failed. Therefore, the recording environment of each patient was different, and environmental compensation was applied by using cepstral mean normalization. This way, the spectral variability which was a result of possible differences in recording environments was compensated by Ozdas [155]. In this study, the audio recordings were recorded during clinical interviews in the same environment for all patients. For this research, both analyses (with and without environmental compensation) are conducted to determine if compensation is still important. It is expected that results without the compensation will give better classification results since compensation may also remove valuable information. The result of this expectation is clarified after the dissertation research had been conducted and found that most of the times the results without environmental compensation were better. The last thing that is improved is analyzing the text dependent speech as well as the text independent speech. Text dependent speech is recorded when the patients are reading the same passage from a predetermined book. Text independent speech is spontaneous speech which is recorded during the clinical interviews in the same environment. In this research, both types of speech samples (text-dependent and text-independent) are analyzed.

In this research, the objective estimation of the suicidal risk will be analyzed using the mel-frequency cepstral coefficients (MFCCs). This paper presents the methodology of this research in Chapter 3.2; Chapter 3.3 will give detailed information about the experimental results of the mel-frequency cepstral coefficients study; Chapter 3.4 will present the performance evaluation for the mel-frequency cepstral coefficients study; and finally Chapter 3.5 will present the discussion and conclusion.

2 Methodology

2.1 Database

Two different types of audio recordings from the depressed patients (diagnosed with depression), the high risk suicidal patients (diagnosed with high risk suicide), and the remitted patients (diagnosed with remission from the depression) were gathered and analyzed. One type is audio recordings that were gathered from the clinical interviews which were completed with a therapist. This type of recording will be named “*Interview Session*”, and is spontaneous speech. The other one was gathered while the patients were reading a predetermined passage named “Rainbow Passage” [161], and they will be named “*Reading Session*”. This passage is a very popular in the speech science. It is phonetically balanced and it contains all of the normal sounds in the spoken English. The *depressed patients* were evaluated during the clinical interview by the psychiatrists using the Hamilton depression rating scale [162]. With this scale, the psychiatrists also evaluated if the patient is at risk of committing suicide, and this group of people are named as *high risk suicidal patients*. The last group of patients is named as *remitted patients* who were recovered from the depression after treatment. Table 1 and Table 2

below show the number of patients in the database for each group of patients for the female and male patients. The ages of the subjects were between 25 and 65 years.

Table 1: The Number of the Female Patients in the Database

FEMALE PATIENTS		
	INTERVIEW	READING
Depressed	18	16
High Risk Suicidal	11	9
Remitted	14	14

Table 2: The Number of the Male Patients in the Database

MALE PATIENTS		
	INTERVIEW	READING
Depressed	11	14
High Risk Suicidal	9	9
Remitted	9	11

All speech samples were digitized with a 16-bit analog to digital converter with a sampling rate of 10 kHz and with a 5 kHz low pass filter (an anti-aliasing filter). The background noises and the voices different from the patient's voice were removed by using the audio editor software named Gold Wave. With the help of this software, silent periods which were longer than 0.5 seconds were removed. In this research, a portable audio acquisition system was used. This system has a Sony VAIO laptop which has a Pentium IV 2 GHz CPU, 512 Mb memory, 60 GB hard drive, 20X CD/DVD read/write unit, 250 GB external hard drive, Windows XP OS, and it has the ProTools LE digital

audio editor; Digital Audio Mbox for the audio signal acquisition; and Audix SCX-one cardioid microphone.

The segments were edited to minimize the introduction of spurious frequency effects resulting from the abrupt transitions in the edited speech by selecting the segmentation points at the zero crossings or at the beginning of the pauses in the edited continuous speech. Afterwards, these edited segments were tested for voicing and only the voiced segments were kept for analyses. Then, the voiced speech was detrended and normalized to have a variance of one for compensating the possible recording level differences. Afterwards, the voiced speech samples were divided into 20 second segments and spectrum analysis was used to determine power spectral density estimates.

2.2 Feature Extraction

In this research, mel-frequency cepstral coefficients (MFCCs) are used as the features. The mel-frequency cepstral coefficients (MFCCs) are coefficients which collectively make up a mel-frequency cepstrum (MFC). The mel-frequency cepstrum (MFC) is a representation of the short-term power spectrum of a sound, based on a linear cosine transform of a log power spectrum on a nonlinear mel-scale of frequency. The difference between the cepstrum and the mel-frequency cepstrum is that in the mel-frequency cepstrum, the frequency bands are equally spaced on the mel-scale.

The mel-scale approximates the human auditory system's response more closely than the linearly-spaced frequency bands used in the normal cepstrum [163]. The

mapping between linearly spaced frequency and mel-scale frequency is shown in the figure below.

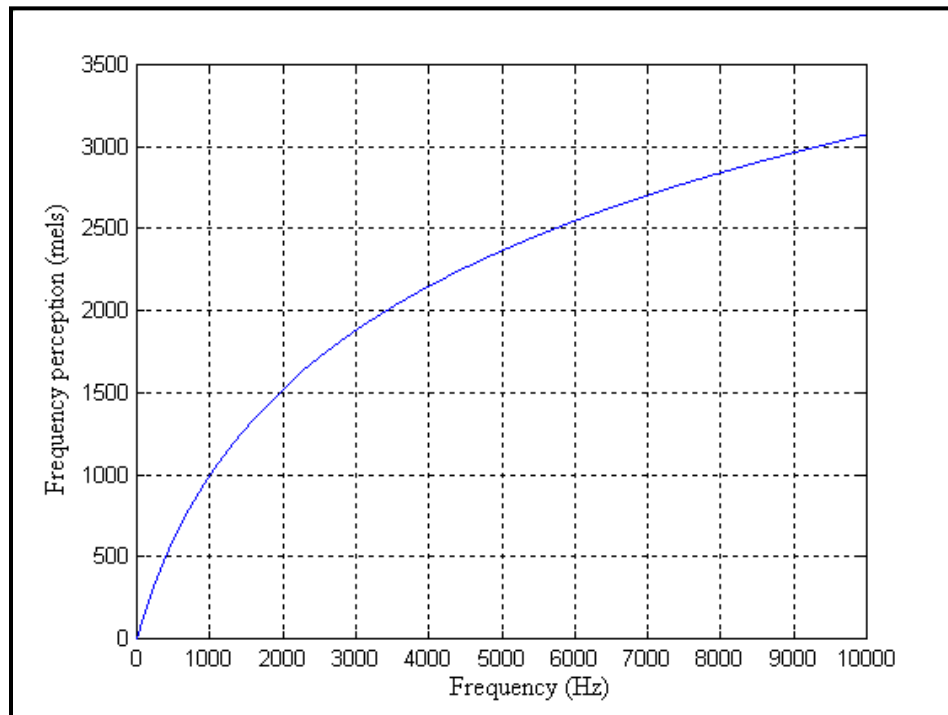

Figure 16: Mapping between Linearly Spaced Frequency and Mel-Scale Frequency

The mel-frequency cepstrum coefficients were extracted using the procedure below:

- Divide each signal into segments of 512 points of voiced speech.
- Compute the log-magnitude spectrum which is the logarithm of the discrete Fourier transform (DFT) for each voiced speech segment.
- Filter the log-magnitude spectrum by a series of 16 triangular band pass filters whose center frequencies are selected according to the mel-scale [164].

- Perform vocal tract length normalization [165] on each subject.
- Calculate the inverse discrete Fourier transform (IDFT) to obtain the mel-frequency cepstral coefficients.

The mel-frequency cepstral coefficients extraction procedure is also shown in Figure 17 below.

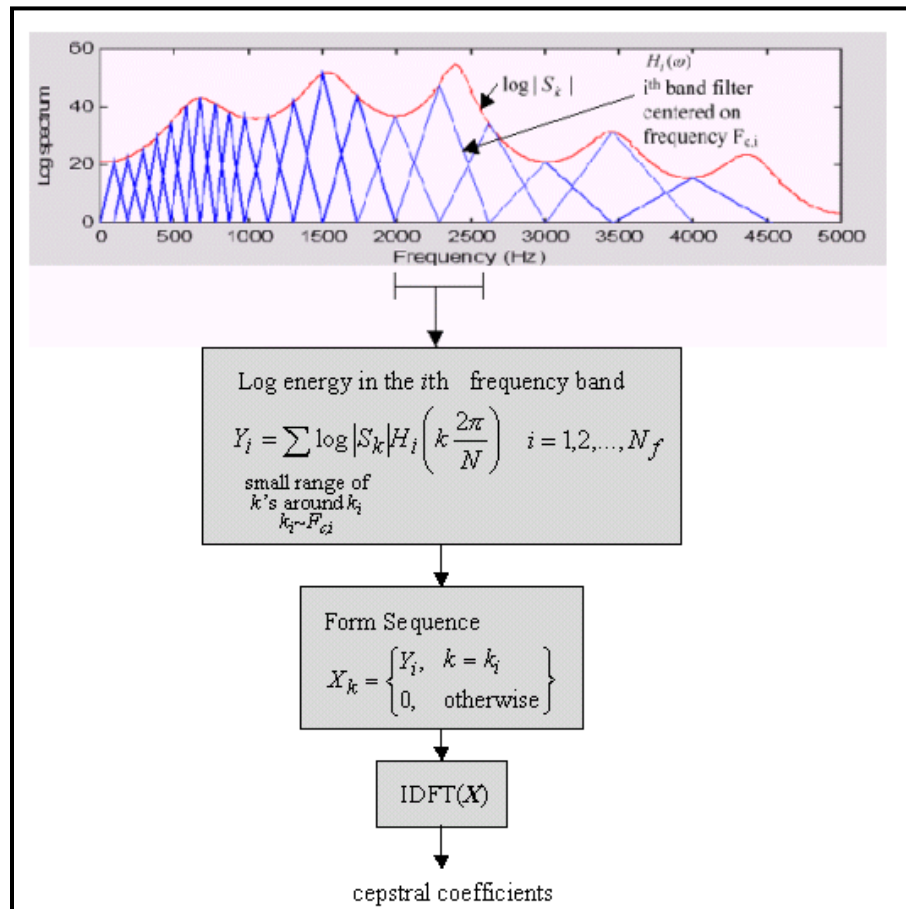

Figure 17: Procedure for Extraction of Mel-Frequency Cepstral Coefficients

There exists variation in vocal tract shape among speakers. The vocal tract length can vary from approximately 13 cm for females to over 18 cm for males. This variability causes a significant degradation. For reducing this degradation, a frequency warping approach was applied. Frequency warping means compressing or stretching in the frequency axis. The vocal tract normalization is applied by warping the frequency by a constant to produce a new frequency scale.

$$\mathbf{f}' = \mathbf{k}_p \cdot \mathbf{f} \quad (\text{Equation 6})$$

In this research, this constant is chosen as follows:

$$k_p = \frac{\text{median}(\{(F_{3,t} + F_{4,t})/2\}_p^{T_p})}{\text{median}(\{(F_{3,t} + F_{4,t})/2\}_p^{T_p})_{p=1}^{30}} \quad (\text{Equation 7})$$

where \mathbf{k}_p : the warping factor

\mathbf{T}_p : voiced frames

\mathbf{P} : patient

Numerator: representation of the patient's vocal tract length (VTL)

Denominator: representation of a baseline vocal tract length (VTL)

In the previous research by Ozdas [155], the database was composed of recordings of suicide notes left on tapes, and interviews of patients who attempted suicide but failed. Therefore, the recording environment of each patient was different. To compensate the spectral variability, environmental compensation was applied by using cepstral mean normalization. This way, the spectral variability which was a result of possible differences in recording environments was compensated by Ozdas [155]. In this study, audio recordings were recorded during clinical interviews in the same environment

for all patients. For this research, both analyses (with and without environmental compensation) are conducted to determine if compensation is still important.

3 Experimental Results of the Mel-Frequency Cepstral Coefficients Study

3.1 The Effect of Environmental Compensation on the Classification Results

This chapter will explain the experimental results of the classification performances with environmental compensation and the classification performances without environmental compensation using different numbers (4, 8, 12, 16, and 20) of mel-frequency cepstral coefficients (MFCCs).

3.1.1 Results without Environmental Compensation

The results without environmental compensation for the depressed and the high risk suicidal patients' classification using the quadratic discriminant analysis are presented below in Table 3 and Table 4 for the female patients and the male patients respectively.

Table 3: Depressed – High Risk Suicidal Classification for the Female Patients (Uncompensated)

FEMALE DP- HR (Uncompensated)		
	INTERVIEW	READING
First 4 MFCCs	69.23%	67.82%
First 8 MFCCs	72.53%	73.37%
First 12 MFCCs	76.08%	78.92%
First 16 MFCCs	79.80%	80.45%
First 20 MFCCs	80.60%	83.73%

Table 4: Depressed – High Risk Suicidal Classification for the Male Patients (Uncompensated)

MALE DP- HR (Uncompensated)		
	INTERVIEW	READING
First 4 MFCCs	70.36%	71.28%
First 8 MFCCs	77.84%	80.62%
First 12 MFCCs	80.63%	83.02%
First 16 MFCCs	80.85%	84.45%
First 20 MFCCs	80.02%	86.14%

The results without environmental compensation for the depressed and the remitted patients' classification using the quadratic discriminant analysis are presented below in Table 5 and Table 6 for the female patients and the male patients respectively.

Table 5: Depressed – Remitted Classification for the Female Patients (Uncompensated)

FEMALE DP- RM (Uncompensated)		
	INTERVIEW	READING
First 4 MFCCs	56.87%	58.64%
First 8 MFCCs	61.93%	63.56%
First 12 MFCCs	64.37%	68.47%
First 16 MFCCs	66.83%	73.83%
First 20 MFCCs	69.51%	74.22%

Table 6: Depressed – Remitted Classification for the Male Patients (Uncompensated)

MALE DP- RM (Uncompensated)		
	INTERVIEW	READING
First 4 MFCCs	64.42%	62.05%
First 8 MFCCs	73.41%	66.00%
First 12 MFCCs	74.83%	71.97%
First 16 MFCCs	76.00%	72.05%
First 20 MFCCs	78.48%	75.23%

The results without environmental compensation for the high risk suicidal and the remitted patients' classification using the quadratic discriminant analysis are presented below in Table 7 and Table 8 for the female patients and the male patients respectively.

Table 7: High Risk Suicidal – Remitted Classification for the Female Patients (Uncompensated)

FEMALE HR- RM (Uncompensated)		
	INTERVIEW	READING
First 4 MFCCs	73.83%	67.18%
First 8 MFCCs	77.49%	71.88%
First 12 MFCCs	77.29%	75.54%
First 16 MFCCs	79.45%	78.14%
First 20 MFCCs	82.44%	84.76%

Table 8: High Risk Suicidal– Remitted Classification for the Male Patients (Uncompensated)

MALE HR- RM (Uncompensated)		
	INTERVIEW	READING
First 4 MFCCs	78.91%	79.53%
First 8 MFCCs	79.14%	85.61%
First 12 MFCCs	84.12%	88.16%
First 16 MFCCs	84.11%	90.26%
First 20 MFCCs	83.30%	91.05%

3.1.2 Results with Environmental Compensation

The results with environmental compensation for the depressed and the high risk suicidal patients’ classification using the quadratic discriminant analysis are presented below in Table 9 and Table 10 for the female patients and the male patients respectively.

Table 9: Depressed – High Risk Suicidal Classification for the Female Patients (Compensated)

FEMALE DP- HR (Compensated)		
	INTERVIEW	READING
First 4 MFCCs	53.58%	53.14%
First 8 MFCCs	56.20%	61.87%
First 12 MFCCs	57.71%	65.85%
First 16 MFCCs	65.82%	70.11%
First 20 MFCCs	67.00%	73.37%

Table 10: Depressed – High Risk Suicidal Classification for the Male Patients (Compensated)

MALE DP- HR (Compensated)		
	INTERVIEW	READING
First 4 MFCCs	57.60%	59.89%
First 8 MFCCs	62.63%	63.48%
First 12 MFCCs	67.71%	70.62%
First 16 MFCCs	73.91%	72.98%
First 20 MFCCs	75.25%	73.86%

The results with environmental compensation for the depressed and the remitted patients' classification using the quadratic discriminant analysis are presented below in Table 11 and Table 12 for the female patients and the male patients respectively.

Table 11: Depressed – Remitted Classification for the Female Patients (Compensated)

FEMALE DP- RM (Compensated)		
	INTERVIEW	READING
First 4 MFCCs	56.26%	56.38%
First 8 MFCCs	61.65%	61.61%
First 12 MFCCs	66.01%	67.68%
First 16 MFCCs	67.17%	73.61%
First 20 MFCCs	69.02%	75.13%

Table 12: Depressed – Remitted Classification for the Male Patients (Compensated)

MALE DP- RM (Compensated)		
	INTERVIEW	READING
First 4 MFCCs	59.67%	54.80%
First 8 MFCCs	66.02%	60.07%
First 12 MFCCs	69.41%	63.18%
First 16 MFCCs	70.66%	65.88%
First 20 MFCCs	72.18%	68.42%

The results with environmental compensation for the high risk suicidal and the remitted patients' classification using the quadratic discriminant analysis are presented below in Table 13 and Table 14 for the female patients and the male patients respectively.

Table 13: High Risk Suicidal – Remitted Classification for the Female Patients (Compensated)

FEMALE HR- RM (Compensated)		
	INTERVIEW	READING
First 4 MFCCs	56.65%	56.92%
First 8 MFCCs	59.64%	60.60%
First 12 MFCCs	64.02%	65.71%
First 16 MFCCs	70.95%	68.11%
First 20 MFCCs	73.34%	73.55%

Table 14: High Risk Suicidal– Remitted Classification for the Male Patients (Compensated)

MALE HR- RM (Compensated)		
	INTERVIEW	READING
First 4 MFCCs	60.43%	59.70%
First 8 MFCCs	67.11%	61.91%
First 12 MFCCs	72.71%	66.08%
First 16 MFCCs	78.40%	70.95%
First 20 MFCCs	78.62%	72.87%

3.2 Depressed – High Risk Suicidal (DP-HR) Classification Results Using MFCCs

The Depressed – High Risk Suicidal (DP-HR) classification analysis is the most important pairwise group among the three classifications of the DP-HR, DP-RM, and HR-RM pairwise groups, since it is really critical thing to distinguish depressed patients becoming high risk suicidal. This pairwise group will be analyzed more in detail.

3.2.1 Depressed – High Risk Suicidal (DP-HR) Classification Results with Different Number of MFCCs and Different Classifiers

Different numbers of mel–frequency cepstral coefficients (MFCCs) have been studied and their effects on the classification rate have been analyzed for both genders using the linear and the quadratic classifiers. The analyses are examined with and without environmental compensation.

Table 15 shows the female patients performance during the interview session with 4, 8, 12, 16, 20 MFCCs using the linear and the quadratic classifiers. The analysis results are obtained both with and without environmental compensation. First part shows the high risk suicidal (HR) patients’ individual performance (classification performance only

for the high risk suicidal patients’ dataset), second part shows the depressed (DP) patients’ individual performance (classification performance only for the depressed patients’ dataset), and finally the third part shows the DP – HR pairwise group performance (classification performance for both depressed and high risk suicidal patients’ dataset).

Table 15: Female Patients Performance during the Interview Session

FEMALE INTERVIEW High Risk Suicidal (HR) Individual Performance					
	4 MFCCs	8 MFCCs	12 MFCCs	16 MFCCs	20 MFCCs
Linear (Compensated)	49.89%	50.14%	49.20%	49.42%	48.75%
Quadratic (Compensated)	36.70%	24.77%	26.73%	41.70%	45.53%
Linear (Uncompensated)	61.36%	62.30%	63.92%	63.97%	63.67%
Quadratic (Uncompensated)	59.71%	59.30%	62.41%	64.87%	65.15%
FEMALE INTERVIEW Depressed (DP) Individual Performance					
	4 MFCCs	8 MFCCs	12 MFCCs	16 MFCCs	20 MFCCs
Linear (Compensated)	51.12%	50.60%	51.64%	52.02%	52.97%
Quadratic (Compensated)	70.66%	87.63%	88.69%	89.94%	88.48%
Linear (Uncompensated)	70.34%	70.69%	72.39%	73.41%	82.27%
Quadratic (Uncompensated)	78.74%	85.75%	89.74%	94.73%	96.05%
FEMALE INTERVIEW HR_DP Pairwise Group Performance					
	4 MFCCs	8 MFCCs	12 MFCCs	16 MFCCs	20 MFCCs
Linear (Compensated)	50.51%	50.37%	50.42%	50.72%	50.86%
Quadratic (Compensated)	53.68%	56.20%	57.71%	65.82%	67.01%
Linear (Uncompensated)	65.85%	66.50%	68.16%	68.69%	72.97%
Quadratic (Uncompensated)	69.23%	72.53%	76.08%	79.80%	80.60%

Table 16 shows the female patients performance during the reading session with 4, 8, 12, 16, 20 MFCCs using the linear and the quadratic classifiers. The analysis results are obtained both with and without environmental compensation. The first part shows the high risk suicidal (HR) patients' individual performance, and the second part shows the depressed (DP) patients' individual performance, and finally the third part shows the DP – HR pairwise group performance.

Table 16: Female Patients Performance during Reading Session

FEMALE READING High Risk Suicidal (HR) Individual Performance					
	4 MFCCs	8 MFCCs	12 MFCCs	16 MFCCs	20 MFCCs
Linear (Compensated)	48.53%	49.02%	48.29%	48.82%	48.65%
Quadratic (Compensated)	52.02%	57.16%	66.88%	70.68%	77.16%
Linear (Uncompensated)	60.62%	64.82%	63.92%	70.96%	76.86%
Quadratic (Uncompensated)	58.43%	65.26%	75.61%	82.27%	87.36%
FEMALE READING Depressed (DP) Individual Performance					
	4 MFCCs	8 MFCCs	12 MFCCs	16 MFCCs	20 MFCCs
Linear (Compensated)	51.59%	50.92%	52.12%	51.25%	51.77%
Quadratic (Compensated)	54.27%	66.58%	64.81%	69.53%	69.58%
Linear (Uncompensated)	64.44%	72.88%	72.39%	74.04%	76.75%
Quadratic (Uncompensated)	77.21%	81.48%	82.23%	86.63%	80.11%
FEMALE READING HR_DP Pairwise Group Performance					
	4 MFCCs	8 MFCCs	12 MFCCs	16 MFCCs	20 MFCCs
Linear (Compensated)	50.06%	49.97%	50.21%	50.04%	50.21%
Quadratic (Compensated)	53.15%	61.87%	65.85%	70.11%	73.37%
Linear (Uncompensated)	62.53%	68.85%	68.16%	72.50%	76.81%
Quadratic (Uncompensated)	67.82%	73.37%	78.92%	80.45%	83.74%

Table 17 shows the male patients performance during the interview session with 4, 8, 12, 16, 20 MFCCs using the linear and the quadratic classifiers. The analysis results are obtained both with and without environmental compensation. The first part shows the high risk suicidal (HR) patients' individual performance, and the second part shows the depressed (DP) patients' individual performance, and finally the third part shows the DP – HR pairwise group performance.

Table 17: Male Patients Performance during the Interview Session

MALE INTERVIEW High Risk Suicidal (HR) Individual Performance					
	4 MFCCs	8 MFCCs	12 MFCCs	16 MFCCs	20 MFCCs
Linear (Compensated)	47.41%	47.60%	47.08%	47.35%	46.98%
Quadratic (Compensated)	42.03%	49.76%	59.23%	59.87%	61.06%
Linear (Uncompensated)	68.51%	70.97%	75.20%	75.75%	78.20%
Quadratic (Uncompensated)	73.05%	70.13%	71.30%	69.00%	66.65%
MALE INTERVIEW Depressed (DP) Individual Performance					
	4 MFCCs	8 MFCCs	12 MFCCs	16 MFCCs	20 MFCCs
Linear (Compensated)	51.47%	49.94%	51.19%	51.23%	51.28%
Quadratic (Compensated)	73.17%	75.50%	75.10%	87.95%	89.44%
Linear (Uncompensated)	68.31%	75.92%	78.34%	83.87%	85.35%
Quadratic (Uncompensated)	67.68%	85.55%	89.97%	92.70%	93.40%
MALE INTERVIEW HR_DP Pairwise Group Performance					
	4 MFCCs	8 MFCCs	12 MFCCs	16 MFCCs	20 MFCCs
Linear (Compensated)	49.44%	48.77%	49.14%	49.29%	49.13%
Quadratic (Compensated)	57.60%	62.63%	67.17%	73.91%	75.25%
Linear (Uncompensated)	68.41%	73.45%	76.77%	79.81%	81.78%
Quadratic (Uncompensated)	70.37%	77.84%	80.64%	80.85%	80.03%

Table 18 shows the male patients performance during the reading session with 4, 8, 12, 16, 20 MFCCs using the linear and the quadratic classifiers. The analysis results are obtained both with and without environmental compensation. The first part shows the high risk suicidal (HR) patients' individual performance, and the second part shows the depressed (DP) patients' individual performance, and finally the third part shows the DP – HR pairwise group performance.

Table 18: Male Patients Performance during Reading Session

MALE READING High Risk Suicidal (HR) Individual Performance					
	4 MFCCs	8 MFCCs	12 MFCCs	16 MFCCs	20 MFCCs
Linear (Compensated)	48.12%	49.46%	48.69%	48.54%	48.05%
Quadratic (Compensated)	42.91%	51.82%	66.50%	72.00%	77.25%
Linear (Uncompensated)	73.85%	83.25%	85.55%	85.01%	85.86%
Quadratic (Uncompensated)	82.55%	84.73%	81.92%	82.27%	83.97%
MALE READING Depressed (DP) Individual Performance					
	4 MFCCs	8 MFCCs	12 MFCCs	16 MFCCs	20 MFCCs
Linear (Compensated)	51.42%	50.97%	50.63%	50.62%	51.08%
Quadratic (Compensated)	76.87%	75.13%	74.75%	73.96%	70.47%
Linear (Uncompensated)	63.16%	73.71%	76.82%	77.73%	77.58%
Quadratic (Uncompensated)	60.01%	76.51%	84.11%	86.63%	88.31%
MALE READING HR_DP Pairwise Group Performance					
	4 MFCCs	8 MFCCs	12 MFCCs	16 MFCCs	20 MFCCs
Linear (Compensated)	49.77%	50.22%	49.66%	49.58%	49.57%
Quadratic (Compensated)	59.89%	63.48%	70.63%	72.98%	73.86%
Linear (Uncompensated)	68.51%	78.48%	81.19%	81.37%	81.72%
Quadratic (Uncompensated)	71.28%	80.62%	83.02%	84.45%	86.14%

3.2.2 Depressed – High Risk Suicidal (DP-HR) Classification Results with Optimal Set of MFCCs

In this part of the research, a different approach is used. For all speech samples, a small subset of the first ten uncompensated mel-frequency cepstral coefficients (MFCCs) is calculated for the each frame. The reason for using a small subset is to bring the number of features down to a level appropriate for the data. Next, the values in each frame are averaged to have one value for each MFCC for each patient. Then a cross validation technique with the quadratic discriminant function is used. In this technique, 65% of the data is used as the training data for the quadratic discriminant function estimation. The rest of the data, i.e., 35% of it, is used as the testing data by performing the classification. This procedure is applied 10 times, and the results are averaged from 10 different runs of cross validation to reduce the variance of the performance estimates. A simple approach had been used to seek sub-optimal combinations of one, two, and three MFCCs for the classification of the Depressed –High Risk Suicidal (DP-HR) pairwise group. The procedure of this approach is described below.

- Apply cross validation classification to each MFCC separately (apply 10 different runs and then take the average of them.)
- Determine the single MFCC giving the best classification → **1 coefficient performance**
- Pair this MFCC with each of the other MFCCs and then apply cross validation classification.
- Determine 2 MFCCs giving the best classification → **2 coefficients performance**

- Repeat the same procedure for 3 coefficients and find 3 coefficients performance
→ **3 coefficients performance**
- Compare all three result sets
- Assign best set as the optimal MFCCs. → **Optimal MFCCs**

This procedure is applied to three different criteria to test the performance of the *maximum depressed classification* alone, the *maximum high risk suicidal classification* alone, and the *maximum total classification*. Table 19 shows the female patients' optimal coefficients and the associated classification rates for one feature performance, two features performance, and three features performance during the interview session. The maximum classification rate results and the associated coefficients for these three different categories are highlighted with yellow.

Table 19: Optimal set of MFCCs for Female DP-HR Pairwise Group during the Interview Session

FEMALE DP- HR INTERVIEW		
1 FEATURE		
	Optimal Coefficient	Classification Rate
Max DP Classification Rate	Coefficient 1	77.00%
Max HR Classification Rate	Coefficient 9	70.10%
Max Total Classification Rate	Coefficient 9	66.40%
2 FEATURES		
	Optimal Coefficients	Classification Rate
Max DP Classification Rate	Coefficient 1 & Coefficient 5	72.80%
Max HR Classification Rate	Coefficient 9 & Coefficient 2	69.20%
Max Total Classification Rate	Coefficient 9 & Coefficient 3	64.70%
3 FEATURES		
	Optimal Coefficient(s)	Classification Rate
Max DP Classification Rate	Coeff 1 & Coeff 5 & Coeff 7	78.90%
Max HR Classification Rate	Coeff 9 & Coeff 2 & Coeff 10	68.20%
Max Total Classification Rate	Coeff 9 & Coeff 3 & Coeff 10	62.70%

Table 20 shows the female patients’ optimal coefficients and the associated classification rates for one feature performance, two features performance, and three features performance during the reading session. The maximum classification rate results and the associated coefficients for these three different categories are highlighted with yellow.

Table 20: Optimal set of MFCCs for Female DP-HR Pairwise Group during Reading Session

FEMALE DP- HR READING		
1 FEATURE		
	Optimal Coefficient	Classification Rate
Max DP Classification Rate	Coefficient 3	65.50%
Max HR Classification Rate	Coefficient 8	71.10%
Max Total Classification Rate	Coefficient 9	63.90%
2 FEATURES		
	Optimal Coefficients	Classification Rate
Max DP Classification Rate	Coefficient 3 & Coefficient 2	70.10%
Max HR Classification Rate	Coefficient 8 & Coefficient 4	66.30%
Max Total Classification Rate	Coefficient 9 & Coefficient 8	59.50%
3 FEATURES		
	Optimal Coefficient(s)	Classification Rate
Max DP Classification Rate	Coeff 3 & Coeff 2 & Coeff 8	66.40%
Max HR Classification Rate	Coeff 8 & Coeff 4 & Coeff 6	62.50%
Max Total Classification Rate	Coeff 9 & Coeff 8 & Coeff 1	57.40%

Table 21 shows the male patients’ optimal coefficients and the associated classification rates for one feature performance, two features performance, and three features performance during the interview session. The maximum classification rate results and the associated coefficients for these three different categories are highlighted with yellow.

Table 21: Optimal set of MFCCs for Male DP-HR Pairwise Group during the Interview Session

MALE DP- HR INTERVIEW		
1 FEATURE		
	Optimal Coefficient	Classification Rate
Max DP Classification Rate	Coefficient 1	71.00%
Max HR Classification Rate	Coefficient 3	97.50%
Max Total Classification Rate	Coefficient 3	74.20%
2 FEATURES		
	Optimal Coefficients	Classification Rate
Max DP Classification Rate	Coefficient 1 & Coefficient 4	78.60%
Max HR Classification Rate	Coefficient 3 & Coefficient 4	79.20%
Max Total Classification Rate	Coefficient 3 & Coefficient 6	75.20%
3 FEATURES		
	Optimal Coefficient(s)	Classification Rate
Max DP Classification Rate	Coeff 1 & Coeff 4 & Coeff 6	76.50%
Max HR Classification Rate	Coeff 3 & Coeff 4 & Coeff 5	62.00%
Max Total Classification Rate	Coeff 3 & Coeff 6 & Coeff 2	69.10%

Table 22 shows the male patients’ optimal coefficients and the associated classification rates for one feature performance, two features performance, and three features performance during the reading session. The maximum classification rate results and the associated coefficients for these three different categories are highlighted with yellow.

Table 22: Optimal set of MFCCs for Male DP-HR Pairwise Group during Reading Session

MALE DP- HR READING		
1 FEATURE		
	Optimal Coefficient	Classification Rate
Max DP Classification Rate	Coefficient 2	69.10%
Max HR Classification Rate	Coefficient 2	93.00%
Max Total Classification Rate	Coefficient 2	78.00%
2 FEATURES		
	Optimal Coefficients	Classification Rate
Max DP Classification Rate	Coefficient 2 & Coefficient 9	75.10%
Max HR Classification Rate	Coefficient 2 & Coefficient 5	78.20%
Max Total Classification Rate	Coefficient 2 & Coefficient 6	73.50%
3 FEATURES		
	Optimal Coefficient(s)	Classification Rate
Max DP Classification Rate	Coeff 2 & Coeff 9 & Coeff 1	89.80%
Max HR Classification Rate	Coeff 2 & Coeff 5 & Coeff 6	84.40%
Max Total Classification Rate	Coeff 2 & Coeff 6 & Coeff 10	76.90%

4 Performance Evaluation for the Mel-Frequency Cepstral Coefficients Study

4.1 The Effect of Environmental Compensation on the Classification Results

Figure 18 shows all the results together for the female DP – HR pairwise group classification with and without environmental compensation during the interview and reading sessions. The female DP-HR classification results without environmental compensation were better for sessions with 4, 8, 12, 16, and 20 MFCCs; and increasing the number of MFCCs gave better results. The classification rate during the reading session was better than for spontaneous speech (during the interview session) without environmental compensation except for 4 MFCCs. With environmental compensation,

the classification rates during the reading session were better than the classification rates during the interview session except for 4 MFCCs.

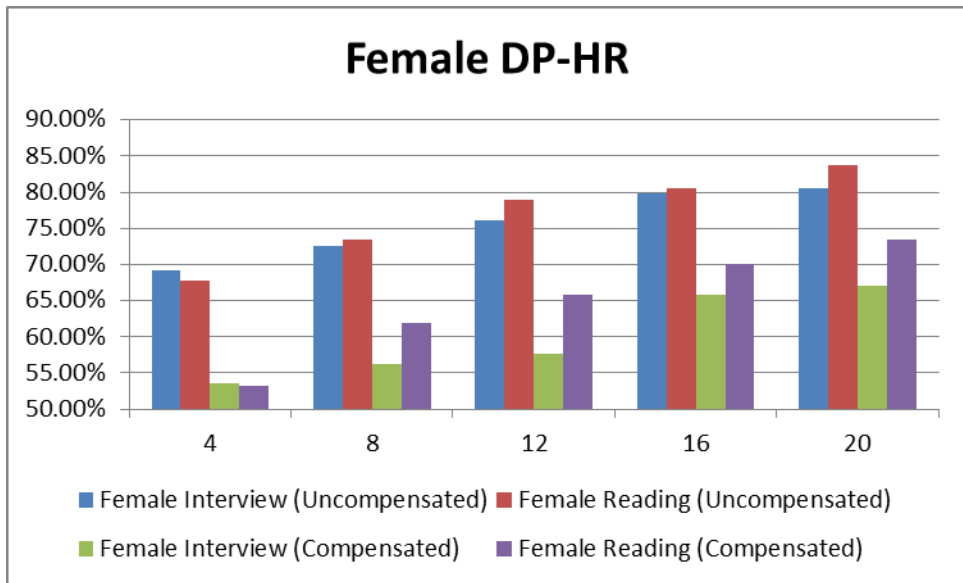

Figure 18: Female Depressed-High Risk Suicidal (DP-HR) Pairwise Group Classification

Figure 19 shows all the results together for the male DP – HR pairwise group classification with and without environmental compensation during the interview and reading sessions. The male DP-HR classification results without environmental compensation were better for the interview and reading sessions with 4, 8, 12, 16, and; 20 MFCCs and increasing the number of MFCCs gave better results. The classification rate during the reading session was better than for spontaneous speech (during the interview session) without environmental compensation. With environmental compensation, the spontaneous speech classification rates were better than the classification rates during the

reading session only for 16 MFCCs and 20 MFCCs. For the other MFCCs (4, 8, 12), the classification rates during the reading session were better than the classification rates during the interview session.

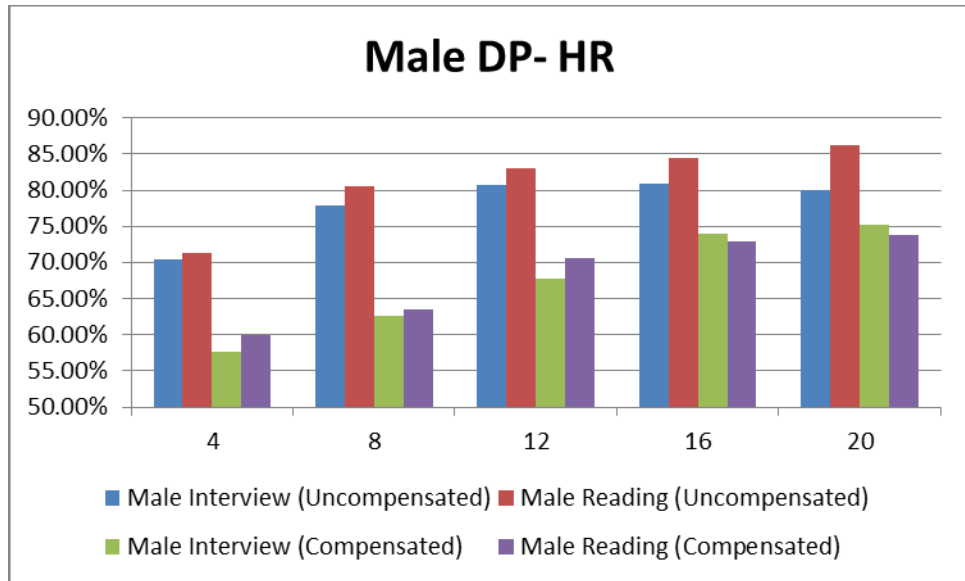

Figure 19: Male Depressed-High Risk Suicidal (DP-HR) Pairwise Group Classification

Figure 20 shows all the results for the female DP – RM pairwise group classification with and without environmental compensation during the interview and reading sessions. The classification rate is increasing when the number of MFCCs is increased. The classification rate during the reading session was better than for spontaneous speech (during the interview session) without environmental compensation. With environmental compensation, the classification rates are about the same during both sessions for 4 MFCCs and 8 MFCCs; but for the 12, 16, and 20 MFCCs the classification

rates during the reading session were better than the classification rates during the interview session.

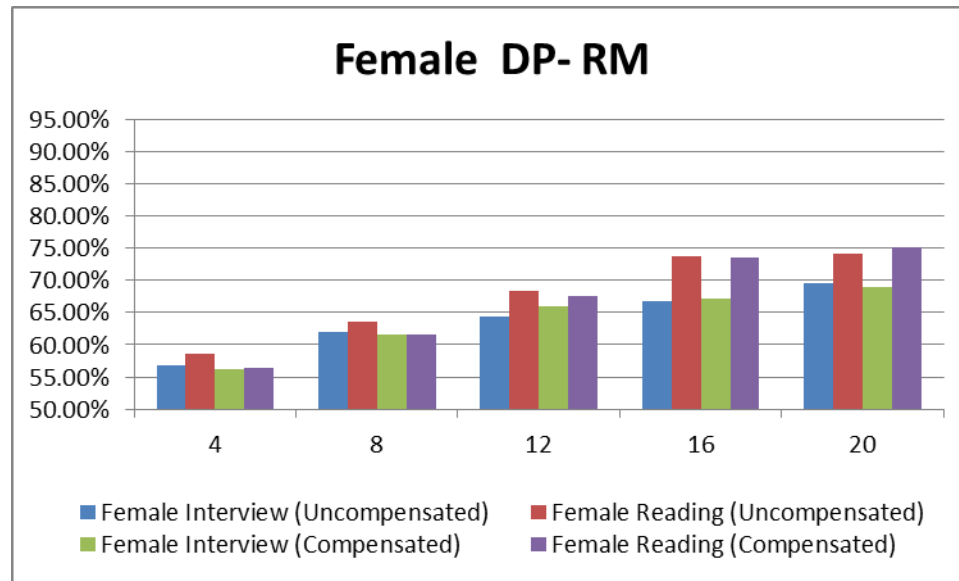

Figure 20: Female Depressed-Remitted (DP-RM) Pairwise Group Classification

Figure 21 shows all the results together for the male DP – RM pairwise group classification with and without environmental compensation during the interview and reading sessions. The male DP-RM classification results without environmental compensation were better for the interview and reading sessions with 4, 8, 12, 16, and; 20 MFCCs. The classification rate is increasing when the number of MFCCs is increased. The classification rate during the interview session was better than the classification rate during the reading session for both of the cases with and without environmental compensation.

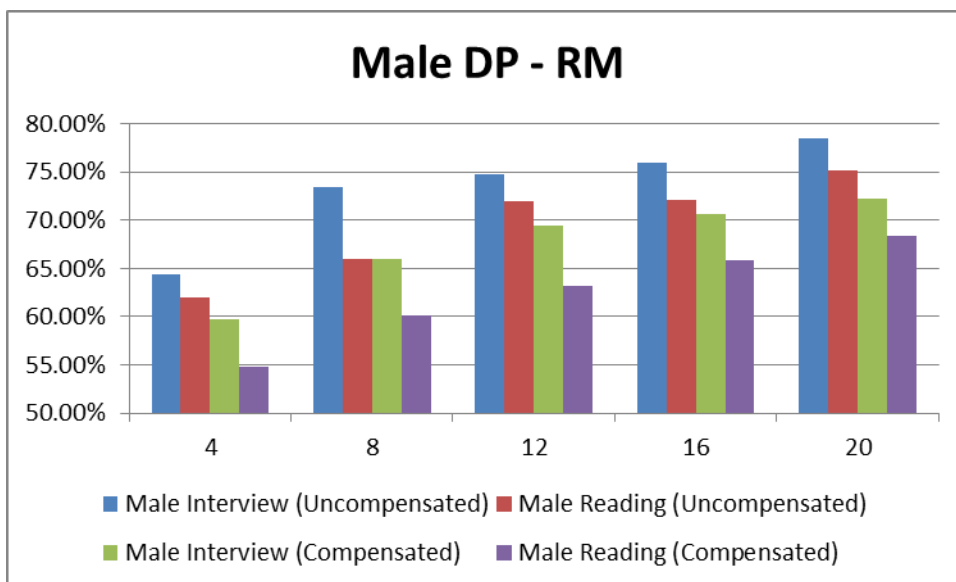

Figure 21: Male Depressed-Remitted (DP-RM) Pairwise Group Classification

Figure 22 shows all the results together for the female HR – RM pairwise group classification with and without environmental compensation during the interview and reading sessions. The female HR – RM classification results without environmental compensation were better for sessions with 4, 8, 12, 16, and 20 MFCCs; and increasing the number of MFCCs gave better results. Without environmental compensation, the classification rate during the interview session was better than the classification rate during the reading session except for 20 MFCCs.

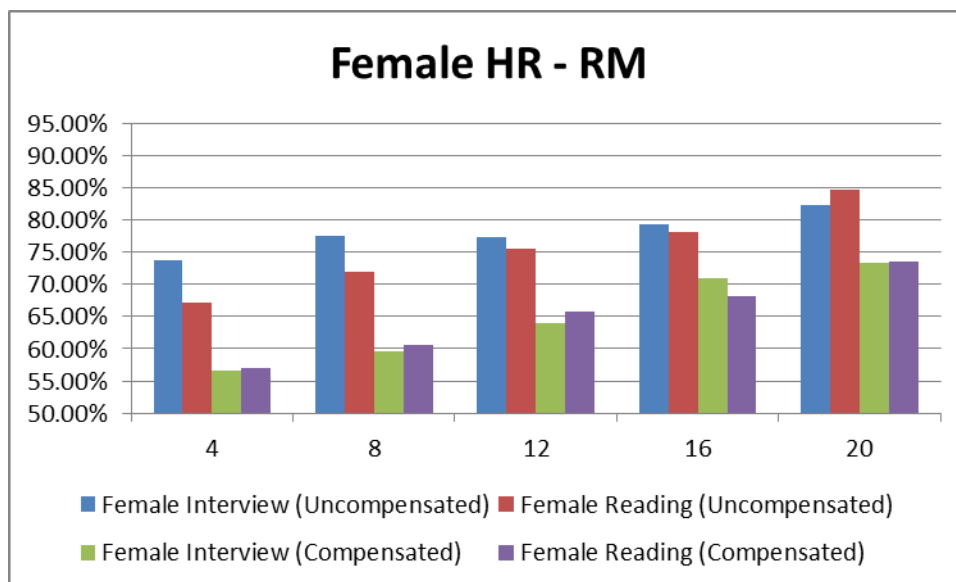

Figure 22: Female High Risk Suicidal-Remitted (HR-RM) Pairwise Group Classification

Figure 23 shows all the results together for the male HR–RM pairwise group classification with and without environmental compensation during the interview and reading sessions. The male HR–RM classification results without environmental compensation were better for the interview and reading sessions with 4, 8, 12, 16, and; 20 MFCCs. The classification rate is increasing when the number of MFCCs is increased. The classification rate during the reading session was better than for spontaneous speech (during the interview session) without environmental compensation. With environmental compensation, the spontaneous speeches’ classification rates were better than the classification rates during the reading session.

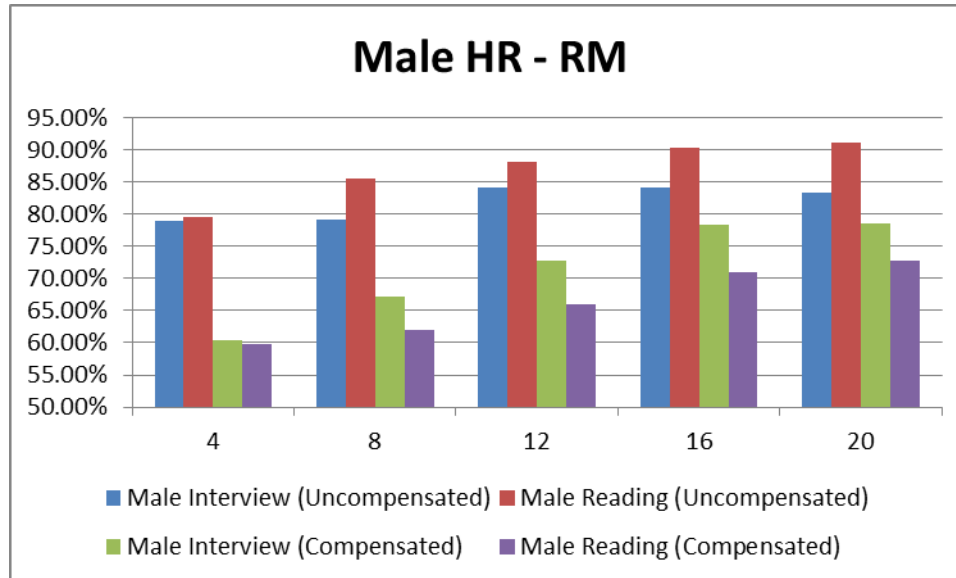

Figure 23: Male High Risk Suicidal-Remitted (HR-RM) Pairwise Group Classification

4.2 Depressed – High Risk Suicidal (DP-HR) Classification Results Using MFCCs

4.2.1 Depressed – High Risk Suicidal (DP-HR) Classification Results with Different Numbers of MFCCs and Different Classifiers

In this research, different numbers of mel-frequency cepstral coefficients (MFCCs) have been studied and their effects on DP-HR classification have been analyzed using two types of classifiers (the linear and the quadratic) with and without environmental compensation.

Figure 24 shows the classification rates of the female high risk suicidal (HR) patients’ performance during the interview session. The results without environmental compensation were better than the results with environmental compensation.

With environmental compensation, the linear classifier gave better results than the quadratic classifier; and without environmental compensation, the linear and the quadratic classifiers gave similar results.

The performances are about the same when the numbers of MFCCs are increased with the linear classifier. With the quadratic classifier, the performance is decreased when the number of MFCCs is increased from 4 to 8; but it is increased when the number of MFCCs is increased from 8 to 12, from 12 to 16, from 16 to 20.

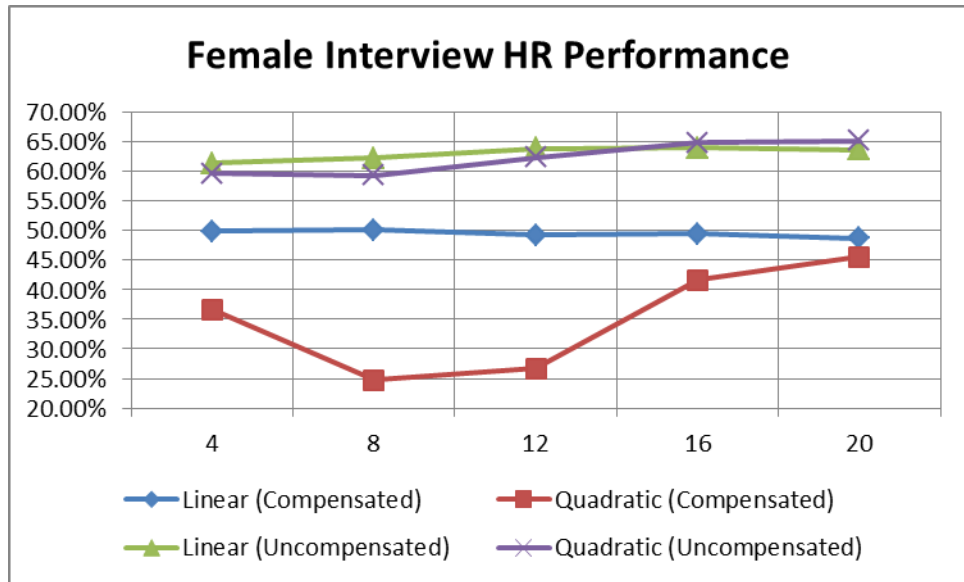

Figure 24: Female HR Performance in the DP-HR Pairwise Group during the Interview Session

Figure 25 shows the classification rates of the depressed (DP) female patients' performance during the interview session. The quadratic classifier gave better results than the linear classifier with and without environmental compensation.

The results without environmental compensation were better than the results with environmental compensation for the linear classifier. For the quadratic classifier,

uncompensated results were better than compensated results for the results with 4, 16, and 20 MFCCs, and it is about the same for the other ones.

The performances are about the same when the numbers of MFCCs are increased with the compensated results of the linear classifier and it is the same except for 20 MFCCs (increased for this one) for the uncompensated results of the linear classifier. With the quadratic classifier, the performance is increased when the number of MFCCs is increased.

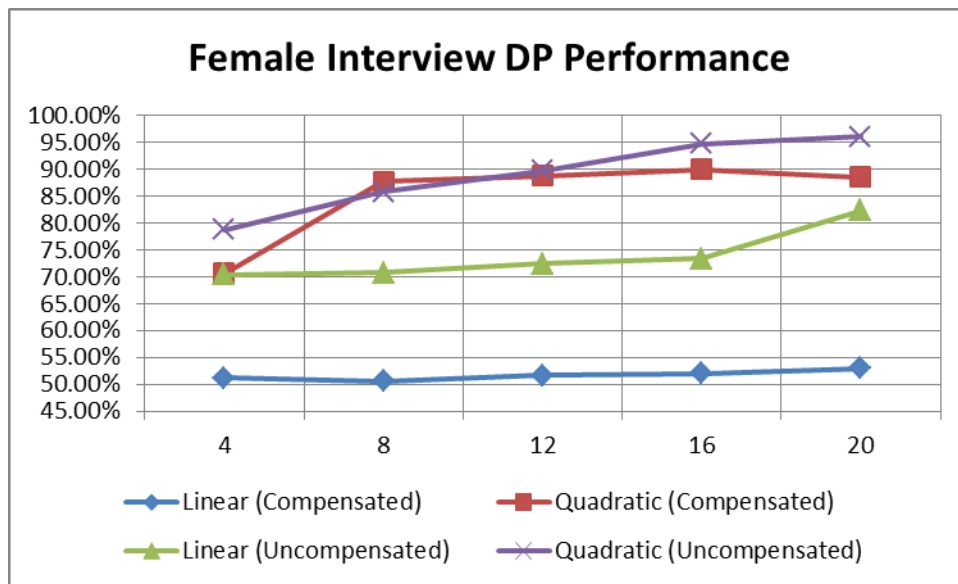

Figure 25: Female DP Performance in the DP-HR Pairwise Group during the Interview Session

Figure 26 shows the classification rates of the female Depressed- High Risk Suicidal (DP-HR) patients' performance during the interview session. The results without

environmental compensation were better than the results with environmental compensation.

The quadratic classifier gave better results than the linear classifier for both compensated and uncompensated cases.

For the results of the linear classifier with environmental compensation, the performances are about the same when the numbers of MFCCs are increased. For the other results, the performance is increased when the number of MFCCs is increased.

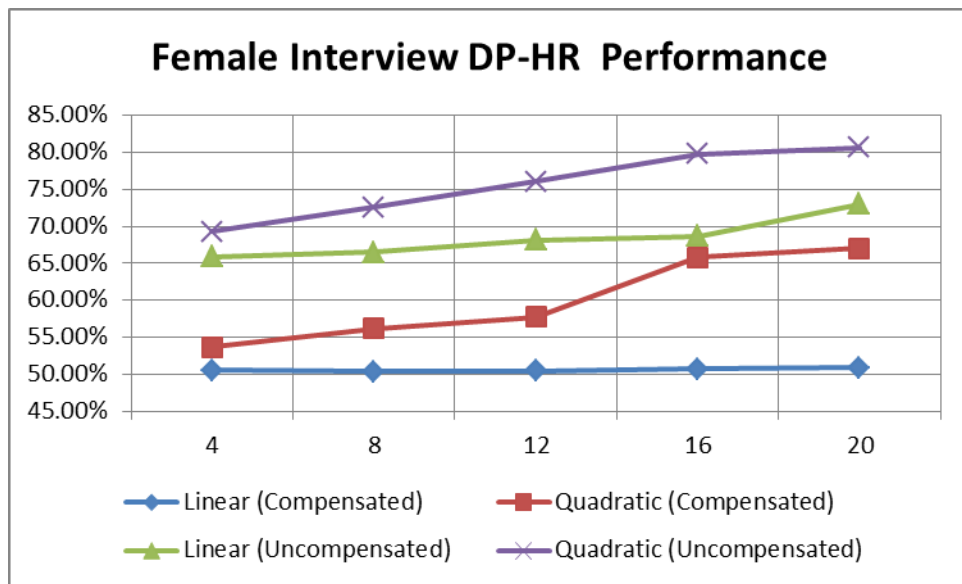

Figure 26: Female DP-HR Performance in the DP-HR Pairwise Group during the Interview Session

Figure 27 shows the classification rates of the high risk suicidal (HR) female patients' performance during the reading session. The quadratic classifier gave better

results than the linear classifier for the results with environmental compensation and for the results without environmental compensation.

The results without environmental compensation were better than the results with environmental compensation for the linear classifier and for the quadratic classifier.

The performances are about the same when the numbers of MFCCs are increased with the compensated results of the linear classifier. With and without environmental compensation of the quadratic classifiers, the performance is increased when the number of MFCCs is increased. With the uncompensated results of the linear classifier, the performance is increased when the number of MFCCs is increased except for increasing the MFCC from 8 to 12.

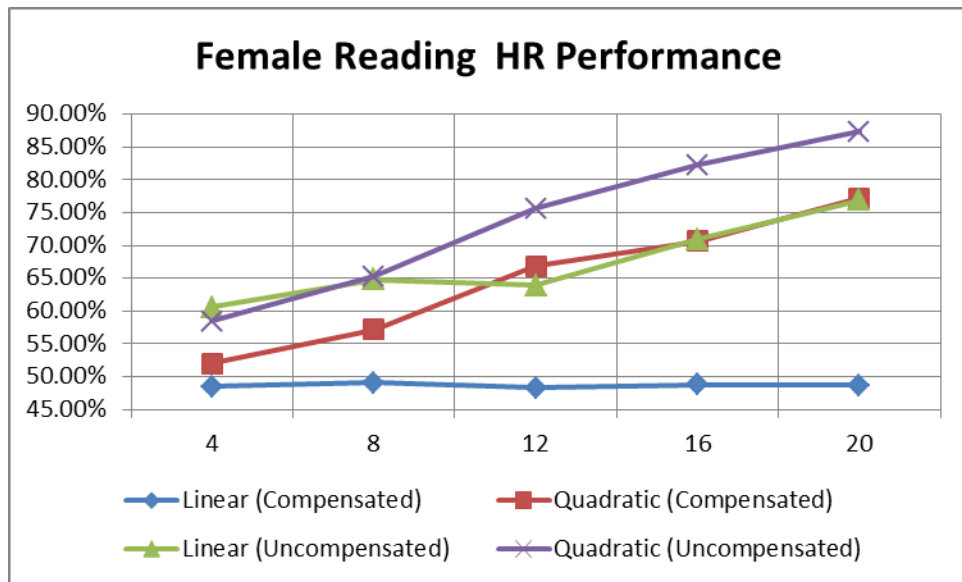

Figure 27: Female HR Performance in the DP-HR Pairwise Group during the Reading Session

Figure 28 shows the classification rates of the depressed (DP) female patients' performance during the reading session. The quadratic classifier gave better results than the linear classifier for the results with environmental compensation and for the results without environmental compensation.

The results without environmental compensation were better than the results with environmental compensation for the linear classifier and for the quadratic classifier.

The performances are about the same when the numbers of MFCCs are increased with the compensated results of the linear classifier. With the uncompensated results of the linear classifier, the performance is increased when the number of MFCCs is increased from 4 to 8 and from 16 to 20, and for the others the performances were about the same. With the compensated results of the quadratic classifier, the performance is increased when the number of MFCCs is increased except for 12 MFCCs. With the uncompensated results of the quadratic classifier, the performance is increased when the number of MFCCs is increased except for 20 MFCCs.

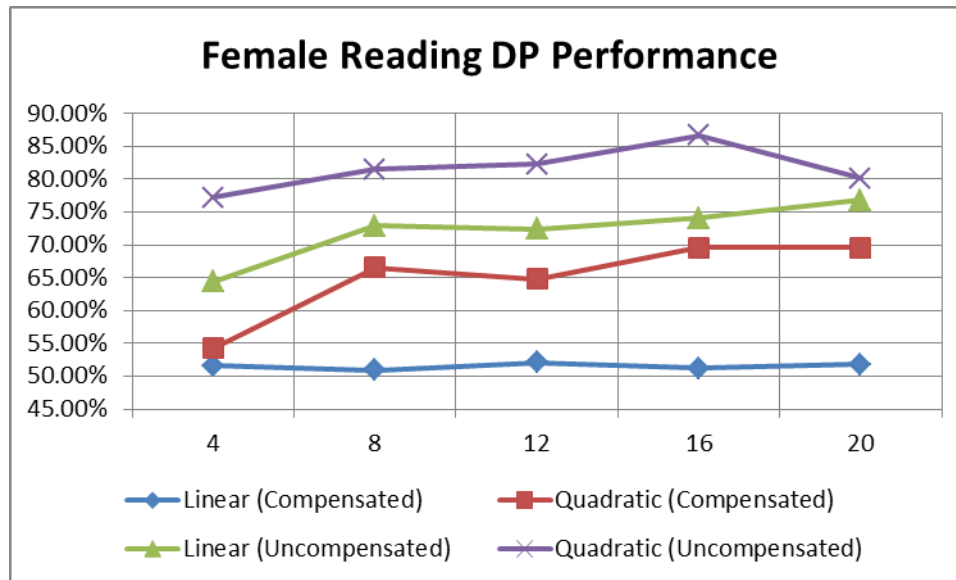

Figure 28: Female DP Performance in the DP-HR Pairwise Group during the Reading Session

Figure 29 shows the classification rates of the Depressed-High Risk Suicidal (DP-HR) female patients' performance during the reading session. The quadratic classifier gave better results than the linear classifier for the results with environmental compensation and for the results without environmental compensation.

The results without environmental compensation were better than the results with environmental compensation for the linear classifier and for the quadratic classifier.

The performances are about the same when the numbers of MFCCs are increased with the compensated results of the linear classifier. With the uncompensated results of the linear classifier, the performance is increased when the number of MFCCs is increased except for 12 MFCCs. With the compensated and uncompensated results of the quadratic classifier, the performance is increased when the number of MFCCs is increased.

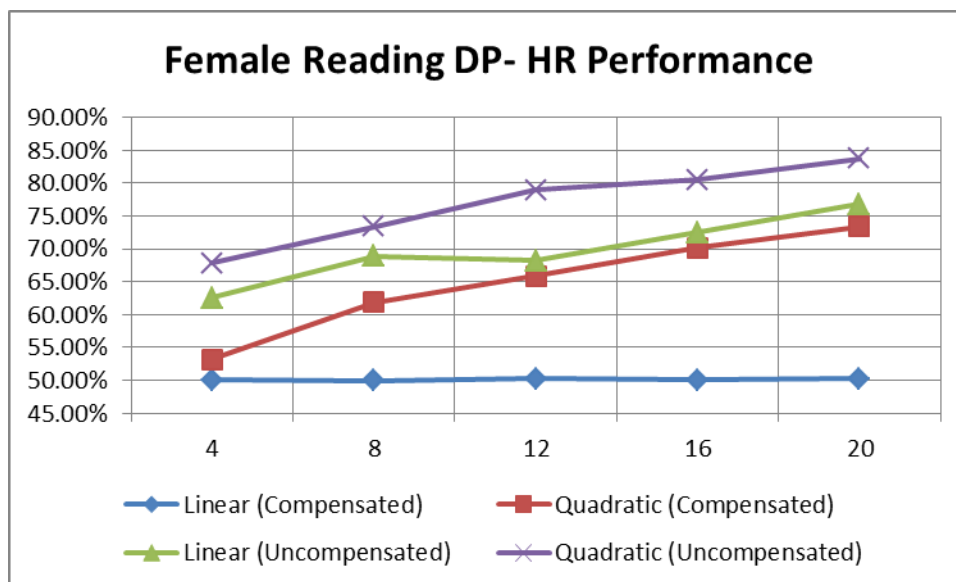

Figure 29: Female DP-HR Performance in the DP-HR Pairwise Group during the Reading Session

Figure 30 shows the classification rates of the high risk suicidal (HR) male patients' performance during the interview session. The quadratic classifier gave better results than the linear classifier for the results with environmental compensation except for 4 MFCCs. The linear classifier gave better results than the quadratic classifier for the results without environmental compensation except for 4 MFCCs and 8 MFCCs. For 4 MFCCs, the quadratic classifier was better than the linear classifier; and for 8 MFCCs, the linear and the quadratic classifiers are about the same.

The results without environmental compensation were better than the results with environmental compensation for the linear classifier and for the quadratic classifier.

The performances are about the same when the numbers of MFCCs are increased with the compensated results of the linear classifier. With the uncompensated results of

the linear classifier and with the compensated result of the quadratic classifier, the performance is increased when the number of MFCCs is increased except for increasing from 12 MFCCs to 16 MFCCs and from 16 MFCCs to 20 MFCCs. With the uncompensated result of the quadratic classifier, the performance is decreased when the number of MFCCs is increased.

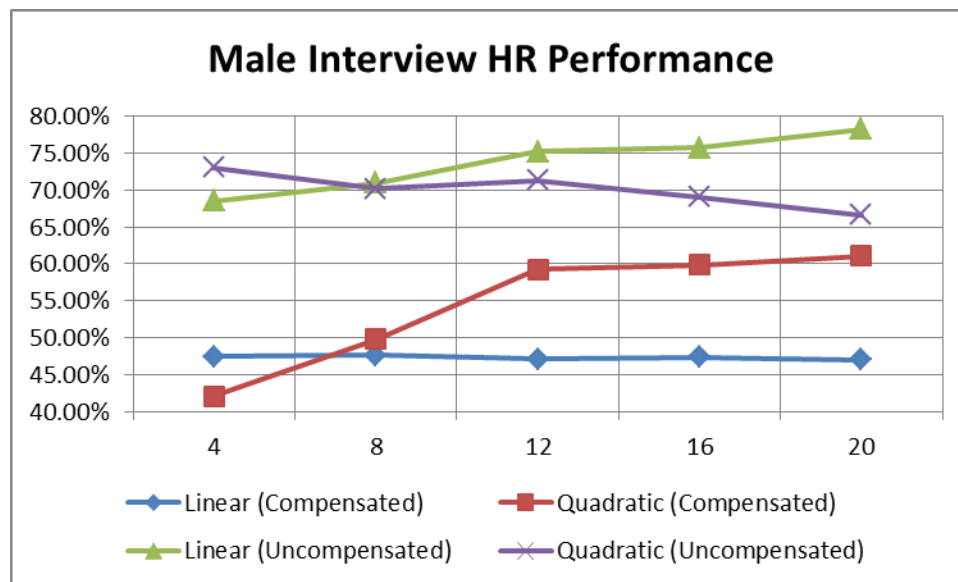

Figure 30: Male HR Performance in the DP-HR Pairwise Group during the Interview Session

Figure 31 shows the classification rates of the depressed (DP) male patients' performance during the interview session. The results without environmental compensation were better than the results with environmental compensation for the linear

classifier. For the quadratic classifier, the uncompensated results were better than the compensated results except for the 4 MFCCs, for 4 MFCCs compensated was better.

The quadratic classifier gave better results than the linear classifier for the results with environmental compensation. The quadratic classifier gave better results than the linear classifier for the results without environmental compensation except for 4 MFCCs. For 4 MFCCs, the linear and the quadratic classifiers' performances are about the same.

The performances are about the same when the numbers of MFCCs are increased with the compensated results of the linear classifier. With the uncompensated results of the linear classifier and the quadratic classifier, the performance is increased when the number of MFCCs is increased. With the compensated result of the quadratic classifier, the performance is increased when the number of MFCCs is increased except for increasing from 8 MFCCs to 12 MFCCs; the performance is decreased for this one.

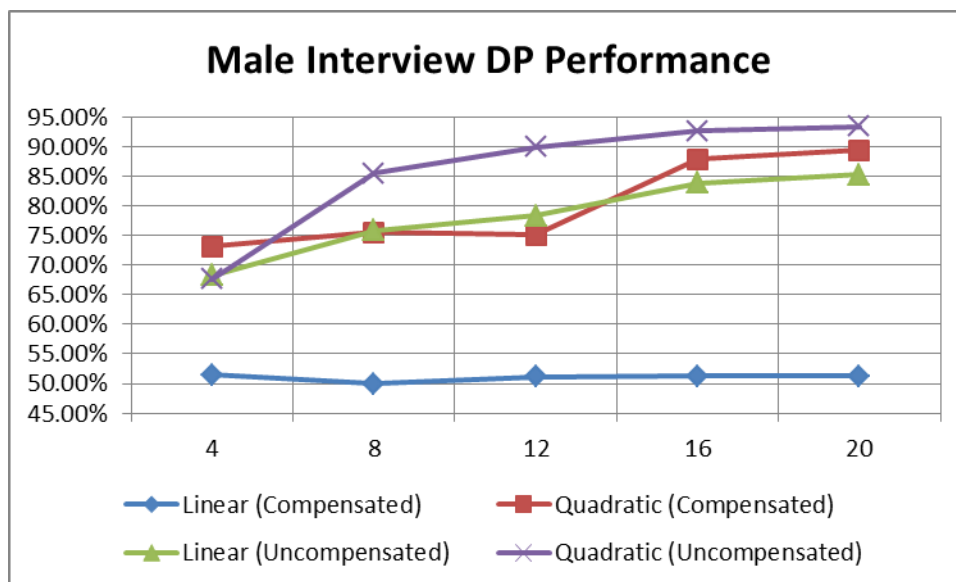

Figure 31: Male DP Performance in the DP-HR Pairwise Group during the Interview Session

Figure 32 shows the classification rates of the Depressed-High Risk Suicidal (DP-HR) male patients' performance during the interview session. For the quadratic classifier and the linear classifier, the uncompensated results were better than the compensated results.

The quadratic classifier gave better results than the linear classifier for the results without environmental compensation except for 20 MFCCs. For 20 MFCCs, the linear classifier's performance was better than the quadratic classifier's performance. The quadratic classifier performance was better than the linear classifier performance for the environmentally compensated case.

The performances are about the same when the numbers of MFCCs are increased with the compensated results of the linear classifier. With the uncompensated results of

the linear classifier, the performance is increased when the number of MFCCs is increased. With the uncompensated results of the quadratic classifier, the performance is increased when the number of MFCCs is increased except for increasing from 16 MFCCs to 20 MFCCs; the performance is decreased for this one. With the compensated result of the quadratic classifier, the performance is increased when the number of MFCCs is increased.

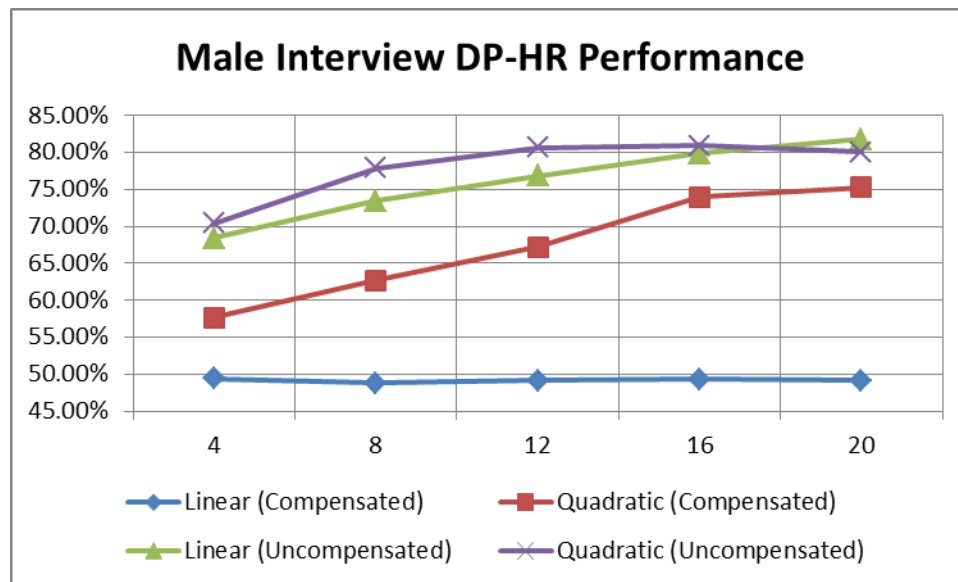

Figure 32: Male DP-HR Performance in the DP-HR Pairwise Group during the Interview Session

Figure 33 shows the classification rates of the high risk suicidal (HR) male patients' performance during the reading session. For the quadratic classifier and the linear classifier, the uncompensated results were better than the compensated results.

The quadratic classifier gave better results than the linear classifier for the results with environmental compensation except for 4 MFCCs. For 4 MFCCs, the linear classifier's performance was better than the quadratic classifier's performance. The quadratic classifier performance is very similar to the linear classifier performance for the environmentally compensated case except for 4 MFCCs, the quadratic classifier was better than the linear classifier for 4 MFCCs.

The performances are about the same when the numbers of MFCCs are increased with the compensated results of the linear classifier. With the compensated result of the quadratic classifier, the performance is increased when the number of MFCCs is increased. With the uncompensated results of the linear classifier; the performance is increased when the number of MFCCs is increased from 4 MFCCs to 8 MFCCs and from 8 MFCCs to 12 MFCCs; the performance does not change when the number of MFCCs is increased from 12 MFCCs to 16 MFCCs and from 16 MFCCs to 20 MFCCs. With the uncompensated results of the quadratic classifier; the performance is increased when the number of MFCCs is increased from 4 MFCCs to 8 MFCCs; the performance is decreased when the number of MFCCs is increased from 8 MFCCs to 12 MFCCs; and it does not change when the number of MFCCs is increased from 12 MFCCs to 16 MFCCs and from 16 MFCCs to 20 MFCCs.

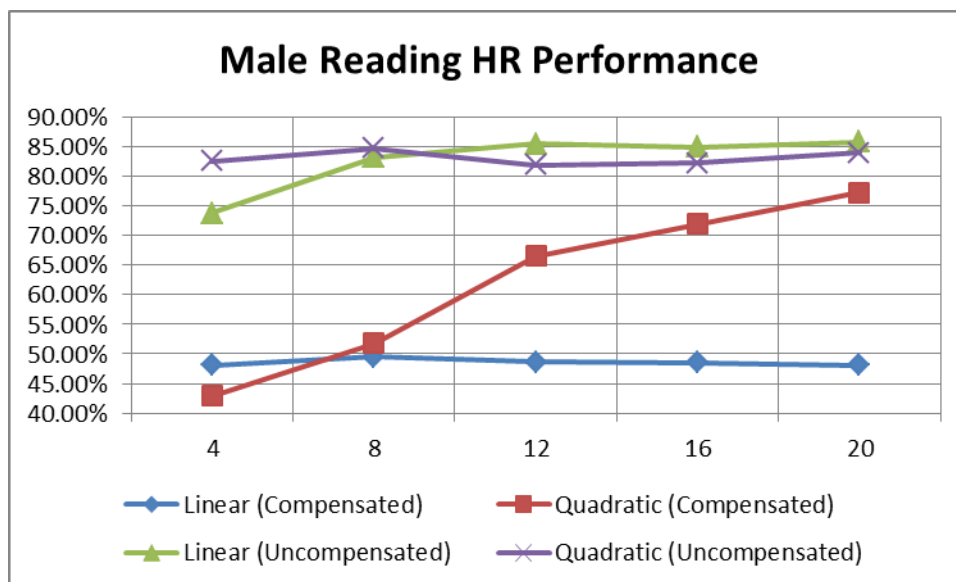

Figure 33: Male HR Performance in the DP-HR Pairwise Group during the Reading Session

Figure 34 shows the classification rates of the depressed (DP) male patients' performance during the reading session. For the linear classifier, the uncompensated performance results were better than the compensated performance results. For the quadratic classifier, the uncompensated performance results were better than the compensated performance results except for 4 MFCCs. For the 4 MFCCs, the compensated performance result was better than the uncompensated performance result.

The quadratic classifier gave better results than the linear classifier for the results with environmental compensation. The quadratic classifier gave better results than the linear classifier for the results without environmental compensation except for 4 MFCCs. For the 4 MFCCs, the linear classifier gave better results than the quadratic classifier.

The performances are about the same when the numbers of MFCCs are increased with the compensated results of the linear classifier. With the compensated result of the

quadratic classifier, the performance is decreased when the number of MFCCs is increased except for increasing from 8 MFCCs to 12 MFCCs. The performance is kept unchanged when the number of MFCCs is increased from 8 MFCCs to 12 MFCCs. With the uncompensated results of the linear classifier; the performance is increased when the number of MFCCs is increased from 4 MFCCs to 8 MFCCs and from 8 MFCCs to 12 MFCCs; the performance does not change when the number of MFCCs is increased from 12 MFCCs to 16 MFCCs and from 16 MFCCs to 20 MFCCs. With the uncompensated results of the quadratic classifier; the performance is increased when the number of MFCCs is increased.

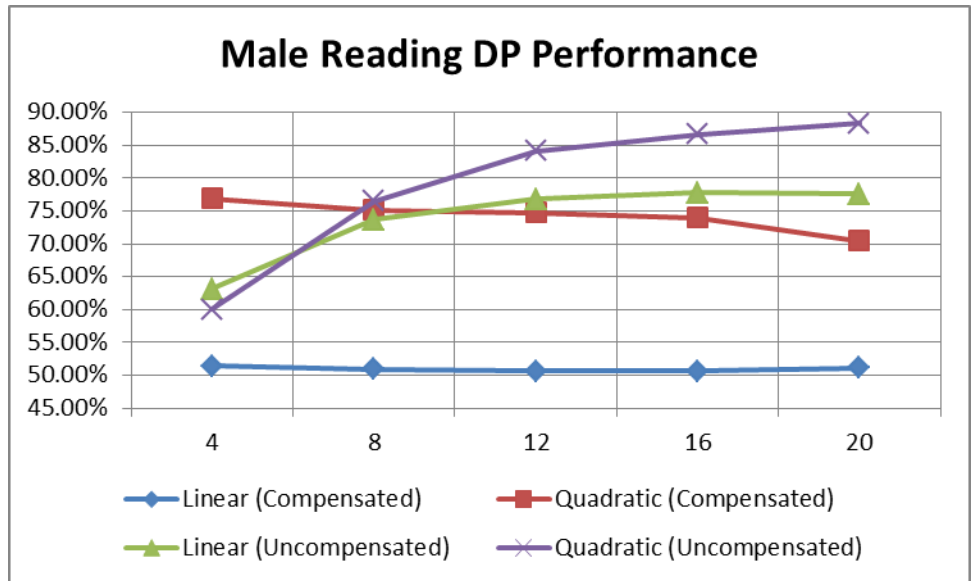

Figure 34: Male DP Performance in the DP-HR Pairwise Group during the Reading Session

Figure 35 shows the classification rates of the Depressed- High Risk Suicidal (DP-HR) male patients' performance during the reading session. For the linear classifier and the quadratic classifier, the uncompensated performance results were better than the compensated performance results.

The quadratic classifier gave better results than the linear classifier for the results with environmental compensation and without environmental compensation.

The performances are about the same when the numbers of MFCCs are increased with the compensated results of the linear classifier. With the compensated result of the quadratic classifier, the performance is increased when the number of MFCCs is increased. With the uncompensated results of the linear classifier and the quadratic classifier, the performance is increased when the number of MFCCs is increased.

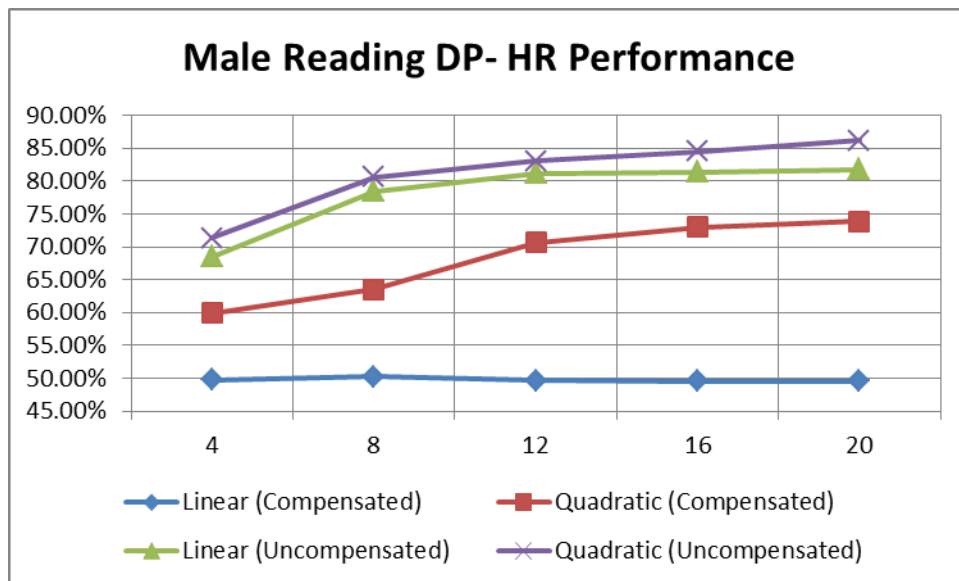

Figure 35: Male DP-HR Performance in the DP-HR Pairwise Group during the Reading Session

4.2.2 Optimal Set of MFCCs and Their Effect on the Classification

The following tables show all the optimal MFCCs. Table 23 below shows the results for the female patients of the Depressed - High Risk Suicidal (DP-HR) pairwise group. The first table is for the interview session and the second one is for the reading session.

For the female DP-HR pairwise group during the interview session, optimal MFCCs are found to be the 1st, the 5th, and the 7th MFCCs for the maximum depressed classification with a performance of 78.90%. For the maximum high risk suicidal classification, the optimal MFCC is the 9th coefficient with a performance of 70.10%. This coefficient is also the optimal MFCC for the maximum total classification with a performance of 66.40%.

Table 23: Optimal MFCC set and Their Classification Performances for Female Patients

FEMALE DP-HR INTERVIEW		
	Optimal Coefficient(s)	Classification Rate
Max DP Classification Rate	Coeff 1, Coeff 5, Coeff 7	78.90%
Max HR Classification Rate	Coefficient 9	70.10%
Max Total Classification Rate	Coefficient 9	66.40%
FEMALE DP-HR READING		
	Optimal Coefficient(s)	Classification Rate
Max DP Classification Rate	Coefficient 3, Coefficient 2	70.10%
Max HR Classification Rate	Coefficient 8	71.10%
Max Total Classification Rate	Coefficient 9	63.90%

For the female DP-HR pairwise group during the reading session, the 3rd and the 2nd MFCCs are found to be the optimal coefficients with a performance of 70.10% for the

maximum depressed classification. For the maximum high risk suicidal classification, the 8th coefficient is the optimal one with 71.10% classification performance. Finally, the 9th coefficient is the optimal MFCC for the maximum total classification with a performance of 63.90%.

Table 24 shows the optimal MFCCs results for the male patients of the Depressed - High Risk Suicidal (DP-HR) pairwise group. The first table is for the interview session and the second one is for the reading session.

For the male interview session, the optimal MFCCs are found to be 1st and the 4th MFCCs for the maximum depressed classification with a performance of 78.60%. For the maximum high risk suicidal classification, the optimal MFCC is the 3rd coefficient with a performance of 97.50 %. For the maximum total classification, the optimal MFCCs are the 3rd and the 6th coefficient with a performance of 75.20 %.

Table 24: Optimal MFCC set and Their Classification Performances for Male Patients

MALE DP-HR INTERVIEW		
	Optimal Coefficient(s)	Classification Rate
Max DP Classification Rate	Coefficient 1, Coefficient 4	78.60%
Max HR Classification Rate	Coefficient 3	97.50%
Max Total Classification Rate	Coefficient 3, Coefficient 6	75.20%
MALE DP-HR READING		
	Optimal Coefficient(s)	Classification Rate
Max DP Classification Rate	Coeff 2, Coeff 9, Coeff 1	89.80%
Max HR Classification Rate	Coefficient 2	93.00%
Max Total Classification Rate	Coefficient 2	78.00%

For the male reading session, the 2nd, the 9th and the 1st MFCCs were found to be the optimal coefficients with a performance of 89.80% for the maximum depressed

classification. For the maximum high risk suicidal classification, the 2nd coefficient is the optimal one with 93.00% classification performance. Finally, the 2nd coefficient is the optimal MFCC for the maximum total classification with a performance of 78.00%.

5 Discussion and Conclusion

5.1 The Effect of Environmental Compensation on the Classification Results of All Possible Pairwise Groups

In the first part of the research, all of the pairwise groups (DP-HR, DP-RM, and HR-RM) are analyzed to find out the effect of environmental compensation for male and female patients during the interview and the reading session. The quadratic classifier is applied to the data set.

For the male patients, the classification results without the environmental compensation were better than the classification results with environmental compensation for all pairwise groups (DP-HR, DP-RM, and HR-RM) for both sessions. For the female patients, the classification results without environmental compensation are better than the classification results with environmental compensation for the Depressed – High Risk Suicidal (DP-HR) pairwise group and High Risk Suicidal – Remitted (HR-RM) pairwise group. For the Depressed – Remitted (DP-RM) pairwise group, the classification results without environmental compensation are better than the classification results with environmental compensation except for 12 MFCCs and 16 MFCCs for the interview session and except for 20 MFCCs for the reading session.

The classification rate of the entire pairwise group for female patients with environmental compensation is increased when the number of mel-frequency cepstral

coefficients (MFCCs) is increased. For the uncompensated case, the classification rate is also increased when the number of MFCCs is increased except for 12 MFCCs during the interview session of the HR-RM pairwise group. For the male patients, the classification rate is increased when the number of MFCCs is increased except for 20 MFCCs during the interview session of the DP-HR pairwise group, except for 16 MFCCs during reading session of the DP-RM pairwise group and finally except for 16 MFCCs and 20 MFCCs during the interview session of the HR-RM pairwise group.

5.2 Depressed – High Risk Suicidal (DP-HR) Classification Results with Different Numbers of MFCCs and Different Classifiers

The Depressed – High Risk Suicidal (DP-HR) pairwise group is analyzed more in detail, since its classification analysis is the most important pairwise group among the other three classifications. Different numbers of mel-frequency cepstral coefficients (MFCCs) have been studied using two different types of classifiers (the linear and the quadratic) with and without environmental compensation. Not only was the DP – HR pairwise group performance analyzed but also the high risk suicidal (HR) patients' individual performance and the depressed (DP) patients' individual performance were examined.

For the female patients, the classification results without environmental compensation were better than the classification results with environmental compensation for the high risk suicidal (HR) patients' individual performance, depressed (DP) patients' individual performance and the DP-HR pairwise group performance for both sessions

(interview and reading) with two different classifiers (the linear and the quadratic) except for the 8 MFCCs of the female interview DP individual performance using the quadratic classifier.

For the male patients, the uncompensated classification results were better than the compensated classification results for the high risk suicidal (HR) patients' individual performance, depressed (DP) patients' individual performance and the DP-HR pairwise group performance for both sessions (interview and reading) with two different classifiers (the linear and the quadratic) except for the 4 MFCCs of the male interview DP individual performance using the quadratic classifier and for the 4 MFCCs of the male reading DP individual performance using the quadratic classifier .

Increasing the number of mel-frequency cepstrum coefficients (MFCCs) gave better classification rates for most of the analyses for female patients but there are also some exceptions. For all the DP, HR and DP-HR performances of female interview and female reading sessions, the compensated results which are analyzed with the linear classifier gave the same results when the number of MFCCs is increased. When the number of MFCCs is increased, the following results are observed for female patients:

- **Female Interview HR Individual Performance:**
 - **Uncompensated/Linear:** results are about the same
 - **Compensated/Linear:** results are about the same
 - **Uncompensated/Quadratic:** results are about the same
 - **Compensated/Quadratic:** increased after 8 MFCCs
- **Female Interview DP Individual Performance:**
 - **Uncompensated/Linear:** increased after 16 MFCCs

- **Compensated/Linear:** results are about the same
- **Uncompensated/Quadratic:** increased
- **Compensated/Quadratic:** increased from 4 to 8 MFCCs, same afterwards
- **Female Interview DP-HR Pairwise Group Performance:**
 - **Uncompensated/Linear:** increased after 16 MFCCs
 - **Compensated/Linear:** results are about the same
 - **Uncompensated/Quadratic:** increased
 - **Compensated/Quadratic:** increased from 12 to 16 MFCCs, same afterwards
- **Female Reading HR Individual Performance:**
 - **Uncompensated/Linear:** increased after 12 MFCCs
 - **Compensated/Linear:** results are about the same
 - **Uncompensated/Quadratic:** increased
 - **Compensated/Quadratic:** increased
- **Female Reading DP Individual Performance:**
 - **Uncompensated/Linear:** increased from 4 to 8 MFCCs, increased from 16 to 20 MFCCs, and about the same in between
 - **Compensated/Linear:** results are about the same
 - **Uncompensated/Quadratic:** increased from 4 to 8 MFCCs, increased from 12 to 16 MFCCs
 - **Compensated/Quadratic:** increased from 4 to 8 MFCCs, increased from 12 to 16 MFCCs
- **Female Reading DP-HR Pairwise Group Performance:**

- **Uncompensated/Linear:** increased from 4 to 8 MFCCs, and increased after 12 MFCCs
- **Compensated/Linear:** results are about the same
- **Uncompensated/Quadratic:** increased
- **Compensated/Quadratic:** increased

For all the DP individual performance, the HR individual performance and the DP-HR pairwise group performances of the female interview and the female reading sessions, the uncompensated results analyzed with the quadratic classifier is the best combination to get high classification results.

Increasing the number of mel-frequency cepstrum coefficients (MFCCs) gave better classification rates for most of the analyses for male patients but there are also some exceptions. For all the DP, HR and DP-HR performances of male interview and male reading sessions, the compensated results analyzed with the linear classifier gave the same results when the number of MFCCs is increased. When the number of MFCCs is increased, the following results are observed for male patients:

- **Male Interview HR Individual Performance:**
 - **Uncompensated/Linear:** slightly increased
 - **Compensated/Linear:** results are about the same
 - **Uncompensated/Quadratic:** decreased
 - **Compensated/Quadratic:** increased until 12 MFCCs
- **Male Interview DP Individual Performance:**
 - **Uncompensated/Linear:** increased
 - **Compensated/Linear:** results are about the same

- **Uncompensated/Quadratic:** increased
- **Compensated/Quadratic:** increased from 12 to 16 MFCCs
- **Male Interview DP-HR Pairwise Group Performance:**
 - **Uncompensated/Linear:** increased
 - **Compensated/Linear:** results are about the same
 - **Uncompensated/Quadratic:** increased until 12 MFCCs
 - **Compensated/Quadratic:** increased
- **Male Reading HR Individual Performance:**
 - **Uncompensated/Linear:** increased from 4 to 8 MFCCs
 - **Compensated/Linear:** results are about the same
 - **Uncompensated/Quadratic:** results are about the same
 - **Compensated/Quadratic:** increased
- **Male Reading DP Individual Performance:**
 - **Uncompensated/Linear:** increased until 12 MFCCs
 - **Compensated/Linear:** results are about the same
 - **Uncompensated/Quadratic:** increased
 - **Compensated/Quadratic:** slightly decreased
- **Male Reading DP-HR Pairwise Group Performance:**
 - **Uncompensated/Linear:** increased from 4 to 8 MFCCs
 - **Compensated/Linear:** results are about the same
 - **Uncompensated/Quadratic:** slightly increased
 - **Compensated/Quadratic:** slightly increased

For all the HR individual performances and the DP-HR pairwise group performances of the male interview and the male reading sessions, the uncompensated quadratic classifier and the uncompensated linear classifier are the best combinations to get high classification results.

For all the DP individual performances of the male interview and the male reading sessions, the uncompensated quadratic classifier is the best combination to get high classification results for all MFCCs except for 4 MFCCs. The compensated quadratic is the best one for 4 MFCCs.

5.3 Optimal Set of MFCCs and Their Effect on the Classification for Depressed – High Risk Suicidal (DP-HR) Pairwise Group

The DP-HR total classification rates were better with the male patients. It is 75.20 % during the interview session and it is 78.00 % during the reading session. On the other hand, the DP-HR total classification for female patients is 66.40 % during the interview session and it is 63.90% during the reading session.

The DP classification rates are about the same for the male patients (78.60%) and the female patients (78.90%) during the interview session. During the reading session, the male patients' rate (89.80%) was better than the female patients' rates (70.10%).

The HR classification rates were better with the male patients. It is 97.50 % during the interview session and it is 93.00 % during the reading session. On the other hand, the HR total classification for female patients is 70.10 % during the interview session and it is 71.10% during the reading session.

Controlled text reading during the reading session (89.80%) was better than the interview session (78.60%) for male DP classification rates. For the male HR classification rates, the interview session (97.50%) gave better results than the reading session (93.00%). For the DP-HR total classification performance of the male patients, the reading session (78.00%) is slightly better than the interview session (75.20%).

The Interview session (78.90%) gave better results than the reading session (70.10%) for female DP classification rates. For the female HR classification rates, both sessions gave about the same classification rates (interview: 70.10% and reading: 71.10%). For the DP-HR total classification performance of the female patients, the interview session (66.40%) is slightly better than the reading session (63.90%).

CHAPTER IV

OBJECTIVE ESTIMATION OF SUICIDAL RISK USING OPTIMIZED ENERGY BANDS

Abstract

Depression is a potentially life threatening mood disorder which affects many people. Two thirds of the people with depression don't realize that depression is a treatable illness, only 50% of people diagnosed with major depression receive any kind of treatment, and only 20% of them get treatment that is in accordance with the current American Psychiatric Association practice guidelines [166, 167]. A recent Canadian research study reported a frightening result which was that 48% of patients who have suicidal ideations and 24% of those who have committed suicide did not receive any care or even perceive the need for care [168]. Therefore, it is very important to evaluate a patient's psychological state and to evaluate a depressed patient's risk of committing suicide, since suicide may be prevented by the psychiatric help. A unique challenge is discriminating the high risk suicidal patients from the depressed patients and this dissertation is focused on tackling this challenge.

The aim of this research is finding optimized energy bands that give better classification rates than the regular energy bands (0-500 Hz, 500- 1000 Hz, 1000-1500 Hz, 1500-2000 Hz) that had been analyzed before with 4 fixed bands and uniformly placed band edges in the 0-2000 Hz frequency range [126,160]. We proposed different approaches to maximize the classification rates of discriminating the high risk suicidal

patients from the depressed patients. The optimization techniques that were used include increasing the number of energy bands, increasing the energy band range, increasing the energy band number & range, exponential band edges, exponential band edges & increasing the energy band range, non-uniform band edges, and finally non-uniform band edges & increasing the energy band range. These approaches gave pretty good classification rates and therefore increased the discriminating the high risk suicidal patients from the depressed patients (DP-HR pairwise group). Other pairwise groups were also analyzed to discriminate the depressed patients from the remitted patients (DP-RM pairwise group) and the high risk suicidal patients from the remitted patients (HR-RM pairwise group).

In this research, different types of classifiers and approaches (linear, quadratic, cross validated) and two different types of speech samples (interview session, reading session) were used. For the female patients, the classification rate is improved by 26.05% for the DP-HR interview group, 24.18% for the DP-HR reading group, 21.37% for the DP-RM interview group, 37.04% for the DP-RM reading group, 15.33% for the HR-RM interview group, 28.30% for the HR-RM reading group. For the male patients, the classification rate is improved by 11.42% for the DP-HR interview group, 30.20% for the DP-HR reading group, 1.81% for the DP-RM interview group, 4.21% for the DP-RM reading group, 12.58% for the HR-RM interview group, 24.89% for the HR-RM reading group. The detailed discussion of the results of these groups is presented in the “Discussion and Conclusion” part of this paper.

1 Introduction

Suicide remains a frequent cause of death in the United States; it was the eleventh leading cause of death in the United States in 2004. It is very important to evaluate a patient's risk of committing suicide, since suicide may be prevented by the psychiatric help. When a patient is seen by a psychiatrist, the psychiatrist evaluates the patient's risk of committing suicide as a part of the clinical interview. Some researchers studied and showed that it is possible to distinguish the high risk suicidal patients from the depressed patients and the control group using the power distribution. The proportion of the total energy in four different frequency sub-bands (0 – 500 Hz, 501 – 1000 Hz, 1001 – 1500 Hz and 1501 – 2000 Hz) were calculated and used for distinguishing the high risk suicidal patients from the depressed patients and the control group by France [126]. The same approach was analyzed by Yingthawornsuk [160]; he performed power distribution analysis on the speech data and obtained power spectral densities between 0 – 2000 Hz with four different frequency ranges of 500 Hz. Yingthawornsuk's research [160] built upon the research begun by France [126]. France's research [126] had limitations such as the size of the patient database, control of the recording environment, and analyzing only the text-independent speech. In the research conducted by Yingthawornsuk [160], energy bands were analyzed in the new database with more patients, in a controlled recording environment which was same for all patients and also with the text-dependent speech as well as the text-independent speech. Nevertheless, both of these studies have a common thing that needs to be improved. In both of these studies, France [126] and Yingthawornsuk [160] analyzed the energy bands to calculate the percentage of the total

energy in four different frequency sub-bands between 0 – 2000 Hz with four different frequency ranges of 500 Hz. In these studies, the number of bands and the ranges of the bands were fixed. They didn't analyze the results if there were five bands between 0 – 2000 Hz or if there were four bands between 0 – 3000 Hz. In this research, these issues were analyzed. Optimization with different numbers of energy bands, optimization with different energy band ranges, and optimization with different energy band edges were explored in the new database with more patients, in a controlled recording environment which will be the same for all patients and also with the text-dependent speech samples as well as the text-independent speech samples.

In this research, the objective estimation of the suicidal risk will be analyzed using the optimized energy bands. This paper presents the methodology of this research in Chapter 4.2; Chapter 4.3 will give detailed information about the experimental results of the optimized energy band study; Chapter 4.4 will present the performance evaluation for the optimized energy band study; and finally Chapter 4.5 will present the discussion and conclusion.

2 Methodology

2.1 Database

Two different types of audio recordings from the depressed patients (diagnosed with depression), high risk suicidal patients (diagnosed with high risk suicide), and remitted patients (diagnosed with remission from the depression) were gathered and analyzed. One type is audio recordings that were gathered from the clinical interviews which were completed with a therapist. This type of recording will be named "*Interview Session*", and is spontaneous speech. The other one was gathered while the patients were

reading a predetermined passage named “Rainbow Passage” [161], and they will be named “*Reading Session*”. This passage is a very popular in the speech science. It is phonetically balanced and it contains all of the normal sounds in the spoken English. The *depressed patients* were evaluated during the clinical interview by the psychiatrists using the Hamilton depression rating scale [162]. With this scale, the psychiatrists also evaluated if the patient is at the risk of committing suicide, and this group of people are named as *high risk suicidal patients*. The last group of patients is named as *remitted patients* who were recovered from the depression after the treatment. The tables below show the number of patients in the database for each group of patients for the female and male patients. The ages of the subjects were between 25 and 65 years.

Table 25: The Number of Female Patients in the Database

FEMALE PATIENTS		
	INTERVIEW	READING
Depressed	18	16
High Risk Suicidal	11	9
Remitted	14	14

Table 26: The Number of Male Patients in the Database

MALE PATIENTS		
	INTERVIEW	READING
Depressed	13	14
High Risk Suicidal	10	9
Remitted	9	11

All speech samples were digitized with a 16-bit analog to digital converter with a sampling rate of 10 kHz and with a 5 kHz low pass filter (an anti-aliasing filter). The

background noises and the voices different from the patient's voice were removed by using the audio editor software named Gold Wave. With the help of this software, the silent periods which were longer than 0.5 seconds were removed. In this research, a portable audio acquisition system was used. This system has a Sony VAIO laptop which has Pentium IV 2 GHz CPU, 512 Mb memory, 60 GB hard drive, 20X CD/DVD read/write unit, 250 GB external hard drive, Windows XP OS, and it has ProTools LE digital audio editor; Digital Audio Mbox for the audio signal acquisition; and Audix SCX-one cardioid microphone.

The segments were edited to minimize the introduction of spurious frequency effects resulting from the abrupt transitions in the edited speech by selecting the segmentation points at the zero crossings or at the beginning of the pauses in the edited continuous speech. Afterwards, these edited segments were tested for voicing and only the voiced segments were kept for analyses. Then, the voiced speech was detrended and normalized to have a variance of one for compensating the possible recording level differences. Afterwards, the voiced speech samples were divided into 20 second segments and used with spectrum analysis to determine power spectral density estimates.

2.2 Feature Extraction

In this research, energy in the frequency bands was used as a feature. Power Spectral Density (PSD) estimate were calculated for each 20 – second voice speech segment using the Welch method with a 400 – point Hamming window and consecutive windows which were non – overlapping. 1024 – point fast Fourier transforms (FFT) were used to implement the PSD estimation algorithm in MATLAB. For the PSD estimates, individual

40 – msec frames of voiced speech were analyzed [126, 150]. The Welch PSD estimation method for extracting the spectral energy band features for four equal energy bands in the frequency range of 0 – 2000 Hz is outlined below in Figure 36:

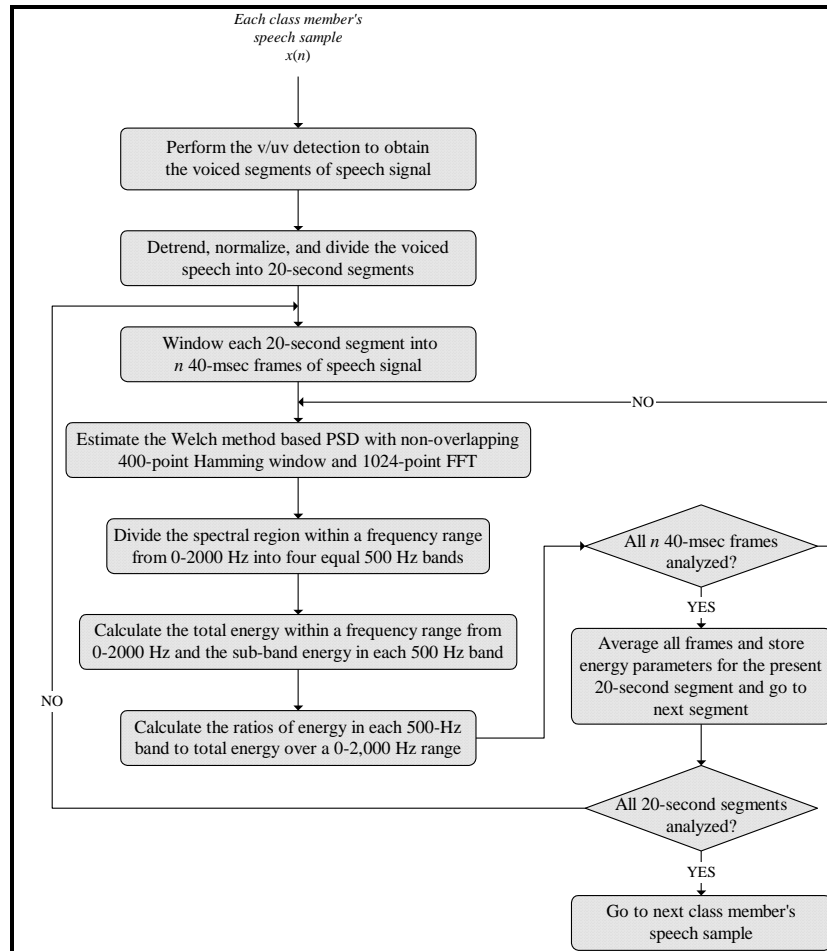

Figure 36: Spectral Energy Feature Extraction Algorithm Flowchart (for 4 equal bands in the 0-2000 Hz band range)

In this research, different methods were used and different numbers of features were extracted to find optimized energy bands for classifying the high risk suicidal from the

depressed and remitted patients. Different numbers of energy bands (2, 3, 4, 5, 6, 7, 8, 9, 10 bands), different energy band ranges (0-2000 Hz, 0-3000 Hz); different energy band edges (exponential and non-uniform edges) were analyzed for finding the optimized energy bands. The following tables show the features (Table 27a) and associated frequency ranges (Table 27b) that were used in this research.

Table 27a: The Features Used in Optimized Energy Bands Study

ANALYSIS TYPE	FEATURES
2 Equal bands in 0 - 2000 Hz	PSD 1, PSD 2
3 Equal bands in 0 - 2000 Hz	PSD 1, PSD 2, PSD 3
4 Equal bands in 0 - 2000 Hz	PSD 1, PSD 2, PSD 3, PSD 4
5 Equal bands in 0 - 2000 Hz	PSD 1, PSD 2, PSD 3, PSD 4, PSD 5
6 Equal bands in 0 - 2000 Hz	PSD 1, PSD 2, PSD 3, PSD 4, PSD 5, PSD 6
7 Equal bands in 0 - 2000 Hz	PSD 1, PSD 2, PSD 3, PSD 4, PSD 5, PSD 6, PSD 7
8 Equal bands in 0 - 2000 Hz	PSD 1, PSD 2, PSD 3, PSD 4, PSD 5, PSD 6, PSD 7, PSD 8
9 Equal bands in 0 - 2000 Hz	PSD 1, PSD 2, PSD 3, PSD 4, PSD 5, PSD 6, PSD 7, PSD 8, PSD 9
10 Equal bands in 0 - 2000 Hz	PSD 1, PSD 2, PSD 3, PSD 4, PSD 5, PSD 6, PSD 7, PSD 8, PSD 9, PSD 10
<hr/>	
2 Equal bands in 0 - 3000 Hz	PSD 1, PSD 2
3 Equal bands in 0 - 3000 Hz	PSD 1, PSD 2, PSD 3
4 Equal bands in 0 - 3000 Hz	PSD 1, PSD 2, PSD 3, PSD 4
5 Equal bands in 0 - 3000 Hz	PSD 1, PSD 2, PSD 3, PSD 4, PSD 5
6 Equal bands in 0 - 3000 Hz	PSD 1, PSD 2, PSD 3, PSD 4, PSD 5, PSD 6
7 Equal bands in 0 - 3000 Hz	PSD 1, PSD 2, PSD 3, PSD 4, PSD 5, PSD 6, PSD 7
8 Equal bands in 0 - 3000 Hz	PSD 1, PSD 2, PSD 3, PSD 4, PSD 5, PSD 6, PSD 7, PSD 8
9 Equal bands in 0 - 3000 Hz	PSD 1, PSD 2, PSD 3, PSD 4, PSD 5, PSD 6, PSD 7, PSD 8, PSD 9
10 Equal bands in 0 - 3000 Hz	PSD 1, PSD 2, PSD 3, PSD 4, PSD 5, PSD 6, PSD 7, PSD 8, PSD 9, PSD 10
<hr/>	
4 Exponential bands in 0 - 2000 Hz	PSD 1, PSD 2, PSD 3, PSD 4
<hr/>	
4 Exponential bands in 0 - 3000 Hz	PSD 1, PSD 2, PSD 3, PSD 4
<hr/>	
4 Non-Uniform bands in 0 - 2000 Hz	PSD 1, PSD 2, PSD 3, PSD 4
<hr/>	
4 Non-Uniform bands in 0 - 3000 Hz	PSD 1, PSD 2, PSD 3, PSD 4

Table 27b: The Frequency Ranges Used in Optimized Energy Bands Study

ANALYSIS TYPE	FREQUENCY RANGES (in Hz)
2 Equal bands in 0 - 2000 Hz	0 - 1000, 1000 - 2000
3 Equal bands in 0 - 2000 Hz	0 - 666, 666 - 1333, 1333 - 2000
4 Equal bands in 0 - 2000 Hz	0- 500, 500 - 1000, 1000 - 1500, 1500 - 2000
5 Equal bands in 0 - 2000 Hz	0- 400, 400 - 800, 800 - 1200, 1200 - 1600, 1600 - 2000
6 Equal bands in 0 - 2000 Hz	0-333, 333-666, 666-1000, 1000-1333, 1333- 1666, 1666-2000
7 Equal bands in 0 - 2000 Hz	0 -285, 285-571, 571-857, 857-1143, 1143-1429, 1429-1715,1715-2000
8 Equal bands in 0 - 2000 Hz	0-250,250-500, 500-750, 750-1000, 1000-1250, 1250-1500, 1500-1750, 1750-2000
9 Equal bands in 0 - 2000 Hz	0-222, 222-445, 445- 667,667-889, 889-1111, 1111-1333, 1333-1555, 1555-1777, 1777- 2000
10 Equal bands in 0 - 2000 Hz	0-200,200-400,400-600,600-800,800-1000,1000-1200,1200-1400,1400-1600,1600-1800,1800-2000
ANALYSIS TYPE	
2 Equal bands in 0 - 3000 Hz	0-1500, 1500- 3000
3 Equal bands in 0 - 3000 Hz	0-1000, 1000-2000, 2000-3000
4 Equal bands in 0 - 3000 Hz	0-750, 750-1500, 1500-2250, 2250-3000
5 Equal bands in 0 - 3000 Hz	0-600, 600-1200, 1200-1800, 1800-2400, 2400-3000
6 Equal bands in 0 - 3000 Hz	0-500, 500-1000, 1000-1500, 1500-2000, 2000-2500, 2500-3000
7 Equal bands in 0 - 3000 Hz	0-428, 428-857, 857-1286, 1286-1714,1714-2142,2142- 2571, 2571- 3000
8 Equal bands in 0 - 3000 Hz	0-375, 375-750, 750-1125,1125-1500,1500-1875, 1875-2250,2250-2625,2625- 3000
9 Equal bands in 0 - 3000 Hz	0-333, 333-667,667 -1000, 1000-1333, 1333-1666, 1666-1999, 1999-2332, 2332-2666, 2666-3000
10 Equal bands in 0 - 3000 Hz	0-300,300-600,600-900, 900-1200, 1200-1500, 1500-1800, 1800-2100, 2100-2400,2400-2700, 2700-3000
ANALYSIS TYPE	
4 Exponential bands in 0 - 2000 Hz	0 - 250 Hz, 250 - 500 Hz, 500 - 1000 Hz, 1000 - 2000 Hz
ANALYSIS TYPE	
4 Exponential bands in 0 - 3000 Hz	0 - 375 Hz, 375 - 750 Hz, 750 - 1500 Hz, 1500 - 3000 Hz
ANALYSIS TYPE	
4 Non-Uniform bands in 0 - 2000 Hz	Check Table 68 in Chapter 4
ANALYSIS TYPE	
4 Non-Uniform bands in 0 - 3000 Hz	Check Table 73 in Chapter 4

Initially, optimization with different numbers of energy bands was analyzed. Different numbers of energy bands were analyzed in the 0 – 2000 Hz frequency range. Instead of analyzing only four equal bands (0-500 Hz, 500-1000 Hz, 1000-1500 Hz, 1500-2000 Hz) in the 0 – 2000 Hz frequency range, two equal bands (0-1000 Hz, 1000-2000 Hz), three equal bands (0-666 Hz, 666-1333 Hz, 1333-2000 Hz), five equal bands (0-400 Hz, 400-800 Hz, 800-1200 Hz, 1200- 1600 Hz, 1600- 2000 Hz), six equal bands (0-333 Hz, 333-666 Hz, 666-1000 Hz, 1000-1333 Hz, 1333-1666 Hz, 1666-2000 Hz), seven equal bands (0-285 Hz, 285-571 Hz, 571-857 Hz, 857-1143 Hz, 1143-1429 Hz, 1429-1715 Hz, 1715-2000 Hz), eight equal bands (0-250 Hz, 250-500 Hz, 500-750 Hz, 750-1000 Hz, 1000-1250 Hz, 1250- 1500 Hz, 1500-1750 Hz, 1750-2000 Hz), nine equal bands (0-222 Hz, 222-445 Hz, 445- 667 Hz, 667-889 Hz, 889-1111 Hz, 1111-1333 Hz, 1333-1555 Hz,

1555-1777 Hz, 1777-2000 Hz) and ten equal bands (0-200 Hz, 200-400 Hz, 400-600 Hz, 600-800 Hz, 800-1000 Hz, 1000-1200 Hz, 1200-1400 Hz, 1400-1600 Hz, 1600- 1800 Hz, 1800-2000 Hz) were examined.

Afterwards, optimization with different band ranges was analyzed. Different numbers of energy bands were studied in the 0 – 3000 Hz frequency range and the difference between 0-2000 Hz and 0-3000 Hz frequency range was analyzed. Two equal bands (0-1500 Hz, 1500-3000 Hz), three equal bands (0-1000 Hz, 1000-2000 Hz, 2000-3000 Hz), four equal bands (0-750 Hz, 750-1500 Hz, 1500-2250 Hz, 2250-3000 Hz), five equal bands (0-600 Hz, 600-1200 Hz, 1200-1800 Hz, 1800- 2400 Hz, 2400- 3000 Hz), six equal bands (0-500 Hz, 500-1000 Hz, 1000-1500 Hz, 1500-2000 Hz, 2000-2500 Hz, 2500-3000 Hz), seven equal bands (0-428 Hz, 428-857 Hz, 857-1286 Hz, 1286-1714 Hz, 1714-2142 Hz, 2142-2571 Hz, 2571-3000 Hz), eight equal bands (0-375 Hz, 375-750 Hz, 750-1125 Hz, 1125-1500 Hz, 1500-1875 Hz, 1875- 2250 Hz, 2250-2625 Hz, 2625-3000 Hz), nine equal bands (0-333 Hz, 333-667 Hz, 667- 1000 Hz, 1000-1333 Hz, 1333-1666 Hz, 1666-1999 Hz, 1999-2332 Hz, 2332-2666 Hz, 2666-3000 Hz) and ten equal bands (0-300 Hz, 300-600 Hz, 600-900 Hz, 900-1200 Hz, 1200-1500 Hz, 1500-1800 Hz, 1800-2100 Hz, 2100-2400 Hz, 2400- 2700 Hz, 2700-3000 Hz) were analyzed.

Finally, optimization with different band edges was analyzed. Exponential band edges and non-uniform band edges were studied. For the exponential band edges study, four exponential energy bands (0-250 Hz, 250-500 Hz, 500-1000 Hz, 1000-2000 Hz) in the 0 – 2000 Hz frequency range, and four exponential energy bands (0-375 Hz, 375-750 Hz, 750-1500 Hz, 1500-3000 Hz) in the 0 – 3000 Hz frequency range were analyzed. For the non-uniform band edges study, the band edge frequency range is swept in between 0

– 2000 Hz frequency range with 250 Hz frequency increment. Thirty five different combinations of non-uniform energy bands edges, which were listed in Table 28, were used in the 0 – 2000 Hz frequency range. These thirty five different combinations cover all possible cases in the 0-2000 Hz frequency range. In this table; X1, X2, and X3 refers to the band edges and the energy bands are created with these edges. The energy bands are (0-X1) Hz, (X1-X2) Hz, (X2-X3) Hz, (X3-2000) Hz. One hundred and sixty five different combinations of non-uniform energy bands edges were determined in the 0 – 3000 Hz frequency range by sweeping the 0 – 3000 Hz frequency range with 250 Hz frequency increment. These 165 different combinations can be seen in Table 73. In this table; X1, X2, and X3 refers to the band edges and the energy bands are created with these edges. The energy bands are (0-X1) Hz, (X1-X2) Hz, (X2-X3) Hz, (X3-3000) Hz. These one hundred and sixty five different combinations cover all possible cases in the 0-3000 Hz frequency range.

Table 28: The Features Used in Finding Optimized Energy Bands

#	X1	X2	X3	#	X1	X2	X3	#	X1	X2	X3
1	250	500	750	16	500	750	1000	26	750	1000	1250
2	250	500	1000	17	500	750	1250	27	750	1000	1500
3	250	500	1250	18	500	750	1500	28	750	1000	1750
4	250	500	1500	19	500	750	1750	29	750	1250	1500
5	250	500	1750	20	500	1000	1250	30	750	1250	1750
6	250	750	1000	21	500	1000	1500	31	750	1500	1750
7	250	750	1250	22	500	1000	1750				
8	250	750	1500	23	500	1250	1500				
9	250	750	1750	24	500	1250	1750	32	1000	1250	1500
10	250	1000	1250	25	500	1500	1750	33	1000	1250	1750
11	250	1000	1500					34	1000	1500	1750
12	250	1000	1750								
13	250	1250	1500								
14	250	1250	1750					35	1250	1500	1750
15	250	1500	1750								

3 Experimental Results of Optimized Energy Band Study

For finding the optimized energy bands for classifying the high risk suicidal patients from the depressed and the remitted patients, different methods were used and different numbers of features were extracted. Different numbers of energy bands (2, 3, 4, 5, 6, 7, 8, 9, 10 bands), different energy band ranges (0-2000 Hz, 0-3000 Hz); different energy band edges (exponential and non-uniform edges) were analyzed for finding the optimized energy bands. This chapter will explain the performance evaluation results of the optimized energy band study.

3.1 Optimization with Different Numbers of Energy Bands

In this research, different numbers of energy bands have been studied and their effects on classification have been analyzed. Different numbers of energy bands were analyzed in the 0 – 2000 Hz frequency range. Instead of analyzing only four equal bands (0-500 Hz, 500-1000 Hz, 1000-1500 Hz, 1500-2000 Hz) in the 0 – 2000 Hz frequency range, two, three, four, five, six, seven, eight, nine and ten equal bands were examined. Table 27b shows the frequency ranges of these energy bands.

Pairwise discriminant analyses were examined by the three different discriminant classifiers; linear discriminant analysis, quadratic discriminant analysis, and cross validated (the leave-one-out classification method) discriminant analysis were used to classify high risk suicidal patients from the depressed patients and the remitted patients.

Three different pairwise groups were investigated for the discriminant analyses. They are Depressed – High Risk Suicidal (DP-HR) pairwise group, Depressed – Remitted (DP-RM) pairwise group, and High Risk Suicidal – Remitted (HR-RM) pairwise group. Two different types of recordings (interview session, reading session) were analyzed for both the female and the male patients. They are speech recordings during the interview session and during the reading session.

3.1.1 Results for the Female Patients

3.1.1.1 Depressed & High Risk Suicidal (DP – HR) Pairwise Group

3.1.1.1.1 Linear Classification Results

In this research, the Depressed – High Risk Suicidal (DP-HR) pairwise group for the female patients were studied. According to the linear classification, 9 bands gave the best discriminating result with a classification rate of 77.90%, 10 bands gave the second best (77.60%) and 8 bands gave the third best discriminating result (77.00%) for the interview session. Figure 37 shows the classification results for the different band numbers for the female DP-HR interview session.

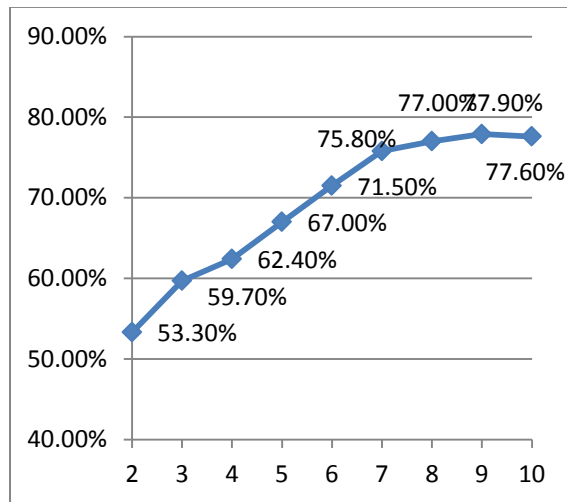

Figure 37 : Female DP – HR Interview Session

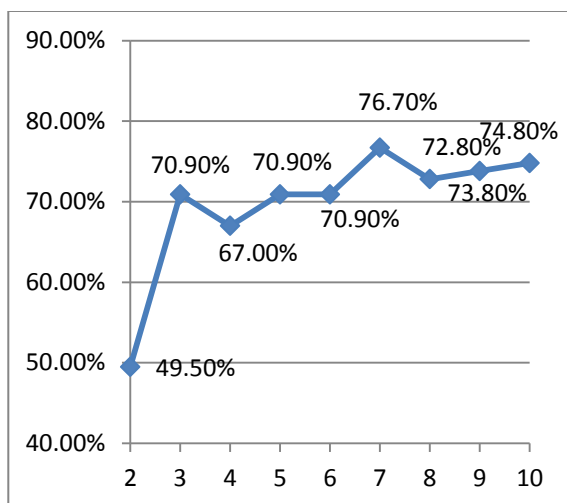

Figure 38: Female DP – HR Reading Session

For the reading session, 7 bands gave the best discriminating result with a classification rate of 76.70%, 10 bands gave the second best (74.80%) and 9 bands gave the third best discriminating result (73.80%). The classification results for different band numbers for the female DP-HR reading session is shown in Figure 38 above.

3.1.1.1.2 Cross Validated Classification Results

According to the cross validated classification which was done by the leave-one-out method, 9 bands gave the best discriminating result (77.90%), 10 bands gave the second best (77.00%) and 8 bands gave the third best discriminating result (76.40%) for the interview session. These results can be seen in Figure 39 below. For the reading session, 7 bands and 3 bands gave the best discriminating result with a classification rate of 68.90%, 9 bands gave the second best (68.00%). The third best discriminating result was taken from the 10 bands and 6 bands results (67.00%). The classification results for the different band numbers for the female DP-HR reading session is shown in Figure 40.

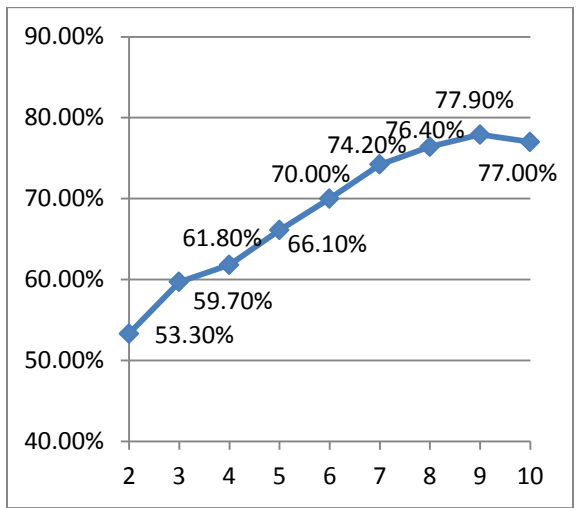

Figure 39: Female DP – HR Interview Session

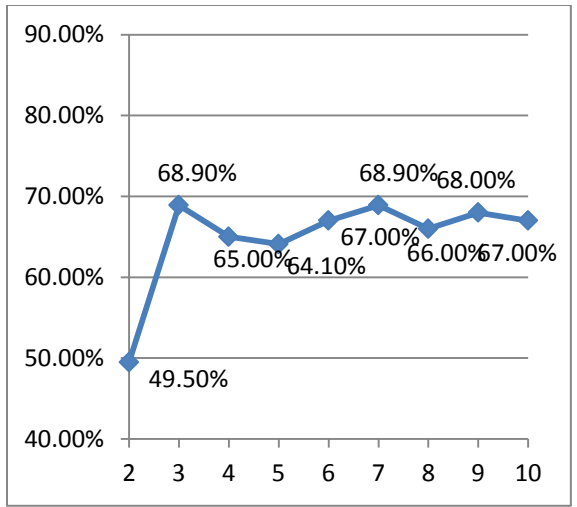

Figure 40: Female DP – HR Reading Session

3.1.1.1.3 Quadratic Classification Results

Quadratic classification results are shown in Figure 41 for the interview session and in Figure 42 for the reading session. 9 bands gave the best discriminating result with a classification rate of 79.40%, 8 bands gave the second best (78.20%) and 10 bands gave the third best discriminating result (77.90%) for the interview session. For the reading session, 7 bands and 10 bands gave the best discriminating result with a classification rate of 73.80%, 8 bands gave the second best (71.80%). The third best discriminating result is 6 bands and 9 bands with a classification rate of 70.90%.

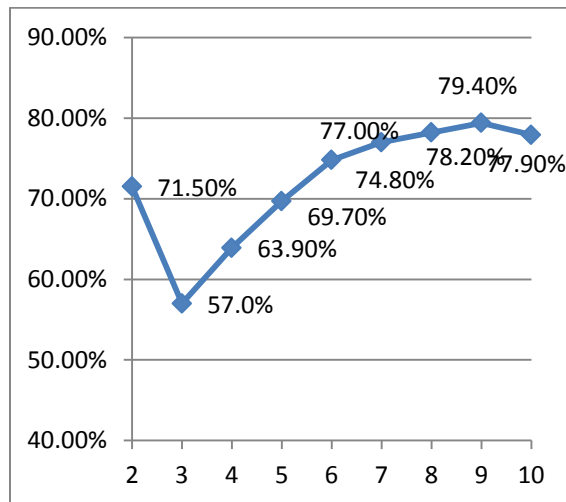

Figure 41: Female DP – HR Interview Session

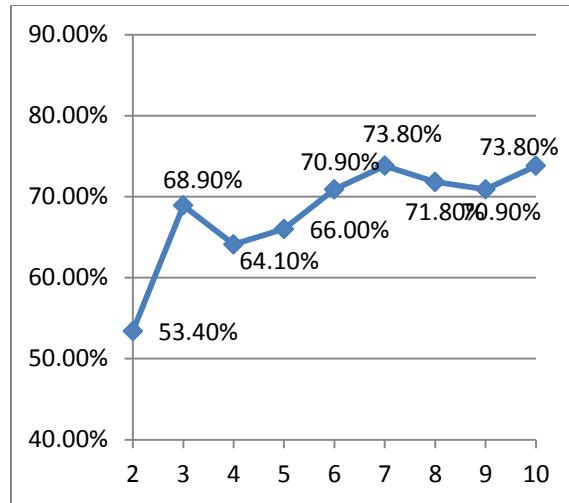

Figure 42: Female DP – HR Reading Session

3.1.1.2 Depressed & Remitted (DP – RM) Pairwise Group

3.1.1.2.1 Linear Classification Results

Linear classification for the Depressed – Remitted (DP-RM) pairwise group for the female patients during the interview session showed that 10 bands gave the best discriminating result with a classification rate of 71.00%, 9 bands gave the second best (65.80%) and 5 bands gave the third best discriminating result (64.50%). Figure 43 shows the classification results for the different band numbers for the female DP-HR interview session. For the reading session, 6 bands gave the best discriminating result with a classification rate of 76.70%, and 10 bands gave the second best (75.80%). 7 bands and 9 bands gave the third best discriminating result (71.80%). The classification results for the different band numbers for the female DP-RM reading session is shown in Figure 44.

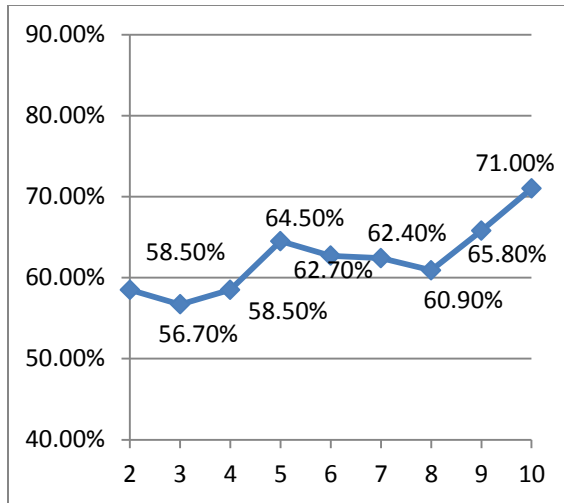

Figure 43: Female DP – RM Interview Session

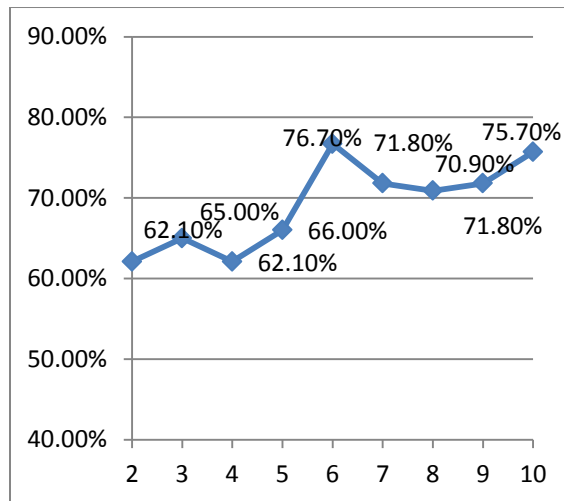

Figure 44: Female DP – RM Reading Session

3.1.1.2.2 Cross Validated Classification Results

The Depressed – Remitted (DP-RM) pairwise group for the female patients were studied and according to the cross validated classification 10 bands gave the best discriminating result (69.90%), 5 bands gave the second best (64.50%) and 9 bands gave

the third best discriminating result (63.70%) for the interview session. These results can be seen in Figure 45 below.

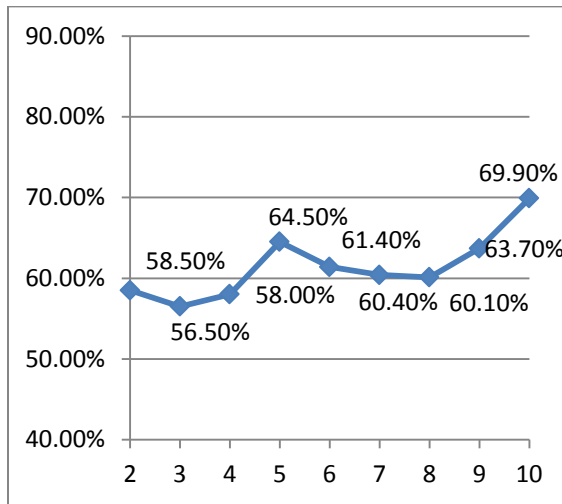

Figure 45: Female DP – RM Interview Session

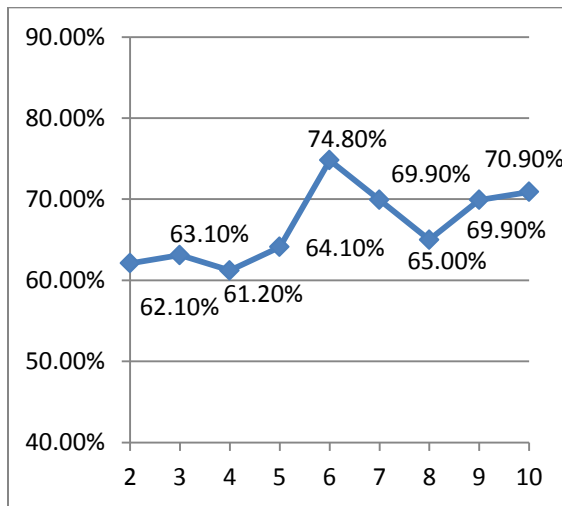

Figure 46: Female DP – RM Reading Session

For the reading session, 6 bands gave the best discriminating result with a classification rate of 74.80%, 10 bands gave the second best (70.90%). The third best result was taken from the 7 bands and 9 bands results (69.90%). The classification results for different band numbers for the female DP-RM reading session is shown in Figure 46 above.

3.1.1.2.3 Quadratic Classification Results

Quadratic classification results are shown in Figure 47 for the interview session and in Figure 48 for the reading session. 10 bands gave the best discriminating result with a classification rate of 72.50%, 9 bands gave the second best (71.20%) and 5 bands gave the third best discriminating result (68.40%) for the interview session. For the reading session, 10 bands gave the best discriminating result with a classification rate of 77.70%, 6 bands gave the second best (75.70%). The third best discriminating result is 9 bands with a classification rate of 74.80%.

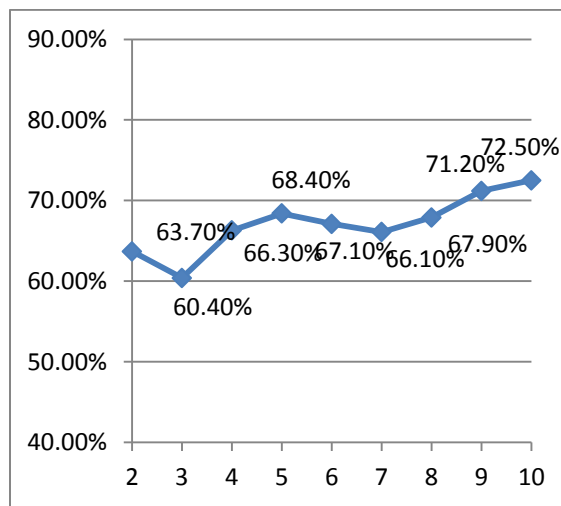

Figure 47: Female DP – RM Interview Session

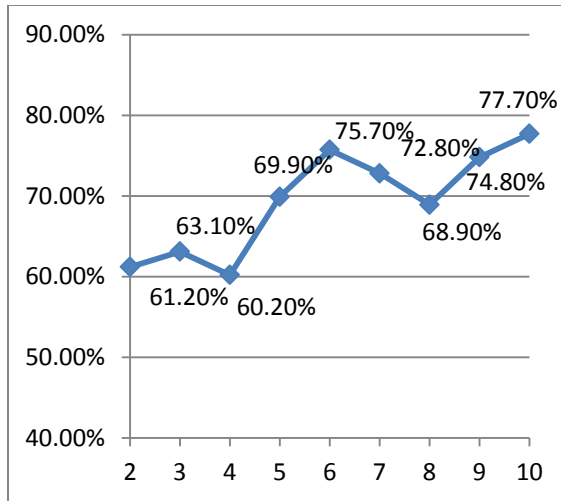

Figure 48: Female DP – RM Reading Session

3.1.1.3 High Risk Suicidal & Remitted (HR – RM) Pairwise Group

3.1.1.3.1 Linear Classification Results

The HR-RM (High Risk Suicidal-Remitted) pairwise group during the interview session was analyzed using the linear classification method and 10 bands gave the best discriminating result with a classification rate of 79.40%. 9 bands and 7 bands gave the second best (75.40%) result, and finally 6 bands gave the third best discriminating result (73.80%). Figure 49 shows the classification results for the different band numbers for the female DP-HR interview session. For the reading session (using the linear classification method), 10 bands gave the best discriminating result with a classification rate of 87.50%, 7 bands gave the second best (85.20%) and 9 bands gave the third best discriminating result (81.80%). Figure 50 shows the classification results for different band numbers for the female DP-HR reading session.

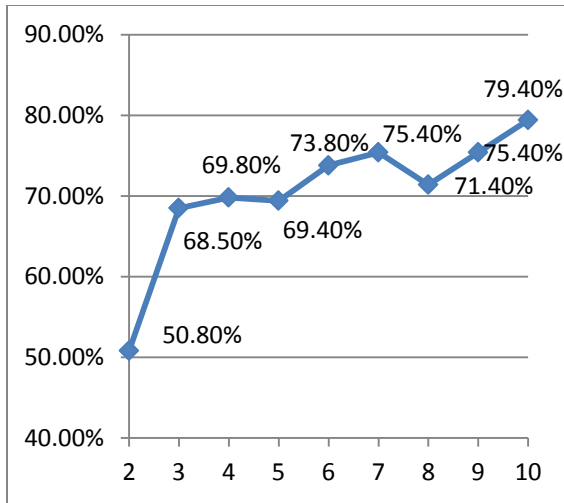

Figure 49: Female HR – RM Interview Session

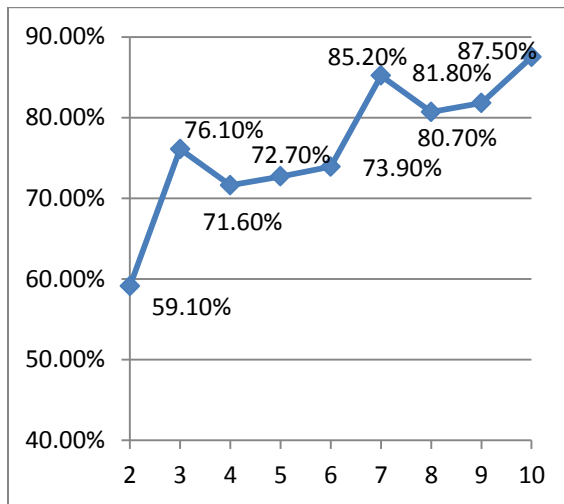

Figure 50: Female HR – RM Reading Session

3.1.1.3.2 Cross Validated Classification Results

Cross validated classification results are shown in Figure 51 for the interview session and in Figure 52 for the reading session. 10 bands gave the best discriminating result with a classification rate of 76.60%; 6, 7, and 9 bands gave the second best

(73.80%); and 3, 5 bands gave the third best discriminating result (68.50%) for the interview session. For the reading session, 7 bands gave the best discriminating result with a classification rate of 83.00%. 9 bands and 10 bands gave the second best (78.40%) result and finally the third best discriminating result is 8 bands with a classification rate of 76.10%.

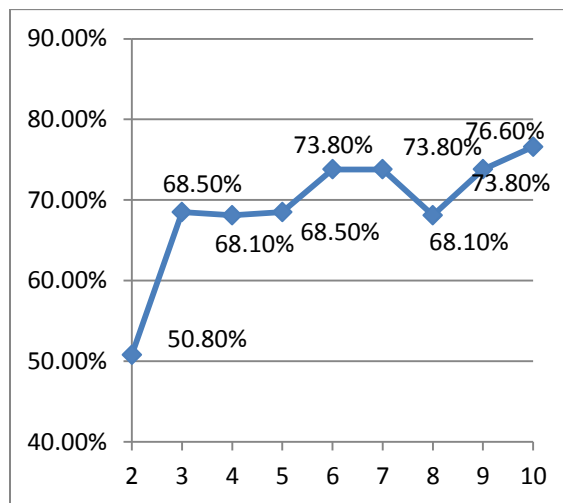

Figure 51: Female HR – RM Interview Session

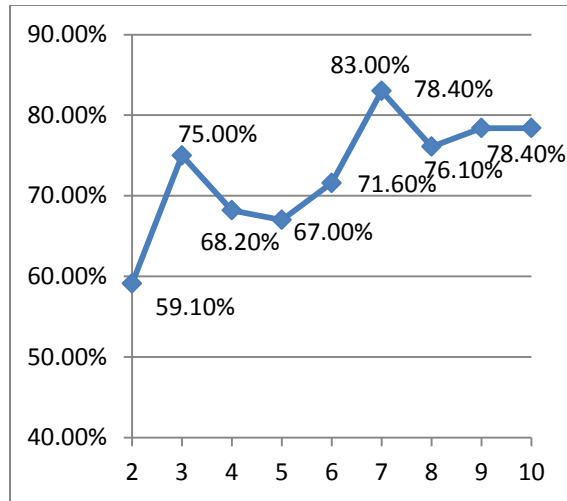

Figure 52: Female HR – RM Reading Session

3.1.1.3.3 Quadratic Classification Results

According to the quadratic discriminant classification, 2 bands gave the best discriminating result (79.00%), 10 bands gave the second best (77.80%) and 7 bands gave the third best discriminating result (75.00%) for the interview session. These results can be seen in Figure 53 below. For the reading session, 10 bands gave the best discriminating result with a classification rate of 87.50%, 7 bands gave the second best (85.20%). The third best discriminating result was taken from the 8 bands (80.70%). The classification results for different band numbers for the female DP-HR reading session is shown below in Figure 54.

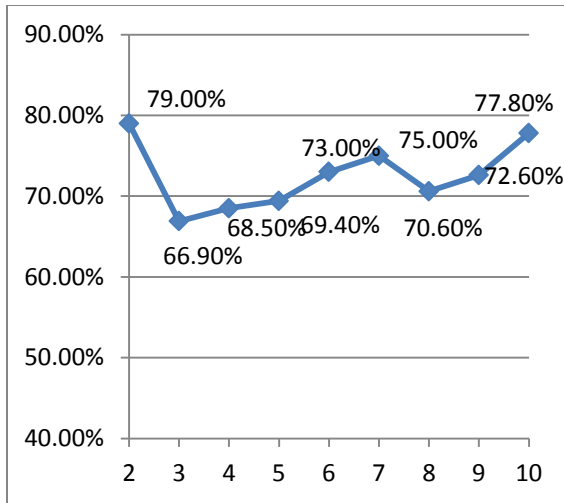

Figure 53: Female HR – RM Interview Session

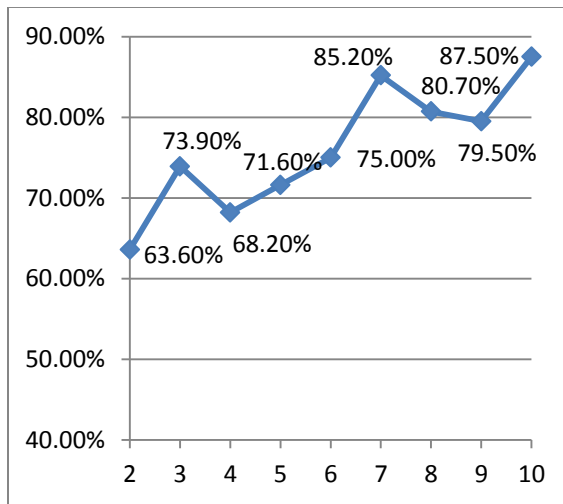

Figure 54: Female HR – RM Reading Session

The following table, Table 29, shows all the best discriminating band/bands (optimized band numbers) of female patients for different pairwise groups with different classification methods. The table also shows the classification rates for these optimized bands.

Table 29: The Best Band Number Results for the Female Patients (0 – 2000 Hz)

Pairwise Group	FEMALE PATIENTS (0 – 2000 Hz)					
	Optimized Band Numbers			Classification Rate		
	Linear	Cross Validated	Quadratic	Linear	Cross Validated	Quadratic
DP – HR Interview	9 bands	9 bands	9 bands	77.90%	77.90%	79.40%
DP – HR Reading	7 bands	7 bands & 3 bands	7 bands & 10 bands	76.70%	68.90%	73.80%
DP – RM Interview	10 bands	10 bands	10 bands	71.00%	69.90%	72.50%
DP – RM Reading	6 bands	6 bands	10 bands	76.70%	74.80%	77.70%
HR – RM Interview	10 bands	10 bands	10 bands	79.40%	76.60%	77.80%
HR – RM Reading	10 bands	7 bands	10 bands	87.50%	83.00%	87.50%

For the female patients, the quadratic classifier seems to be the best discriminant classifier for the DP-RM pairwise group for both types of speech samples (the interview session, the reading session) for the 0 – 2000 Hz frequency range. For the HR-RM pairwise group, the linear classifier is the best classifier for the interview session. For the reading session, both the linear and the quadratic classifiers gave the same best result. The quadratic classifier seems to be the best classifier for the DP-HR interview session. On the other hand, the linear classifier seems to be the best classifier for the DP-HR reading session.

For the DP-RM pairwise group, 10 bands give the best results for both sessions (72.50% for the interview session and 77.70% for the reading session). So, 10 bands is the optimized band number for both the DP-RM interview session and the DP-RM reading session. 10 bands is also the optimized band number for the HR-RM pairwise

group for both sessions. It gave 79.40% classification rate for the HR-RM interview session and 87.50% classification rate for the HR-RM reading session. 9 bands is the optimized band number for the DP-HR interview session with a classification rate of 79.40% and 7 bands is the optimized band number for the DP-HR reading session with a classification rate of 76.70%.

3.1.2 Results for the Male Patients

3.1.2.1 Depressed & High Risk Suicidal (DP – HR) Pairwise Group

3.1.2.1.1 Linear Classification Results

The linear classification for the Depressed – Remitted (DP-HR) pairwise group for the male patients during the interview session showed that 9 bands gave the best discriminating result with a classification rate of 75.90%, 3 bands gave the second best (75.60%). The third best discriminating result were 6 bands and 10 bands (74.30%). Figure 55 shows the classification results for the different band numbers for the male DP-HR interview session. For the reading session, 10 bands gave the best discriminating result with a classification rate of 76.00%; 7 bands and 8 bands gave the second best (71.90%); and 9 bands gave the third best discriminating result (70.80%). The classification results for the different band numbers for the male DP-RM reading session are shown in Figure 56.

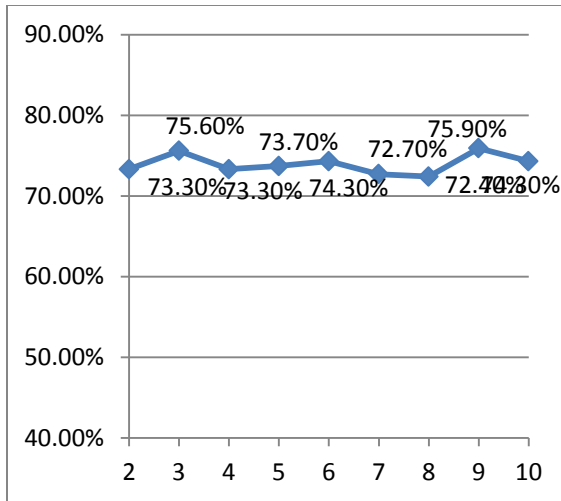

Figure 55: Male DP – HR Interview Session

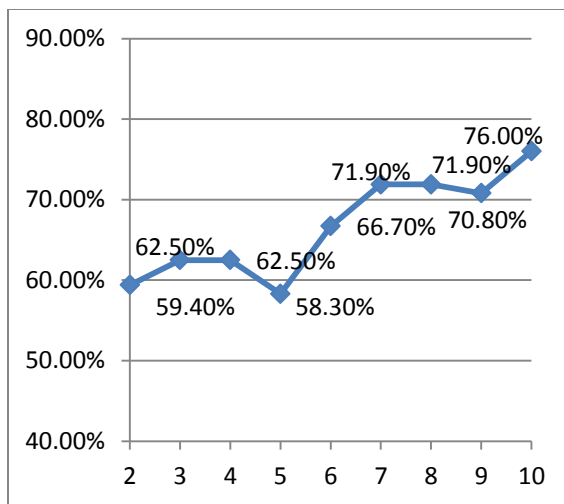

Figure 56: Male DP – HR Reading Session

3.1.2.1.2 Cross Validated Classification Results

The leave-one-out method was used for the cross validated classification and 3 bands gave the best discriminating result (75.20%). 9 bands gave the second best (74.60%); 6 bands and 10 bands gave the third best discriminating result (74.00%) for the interview session. These results can be seen below in Figure 57.

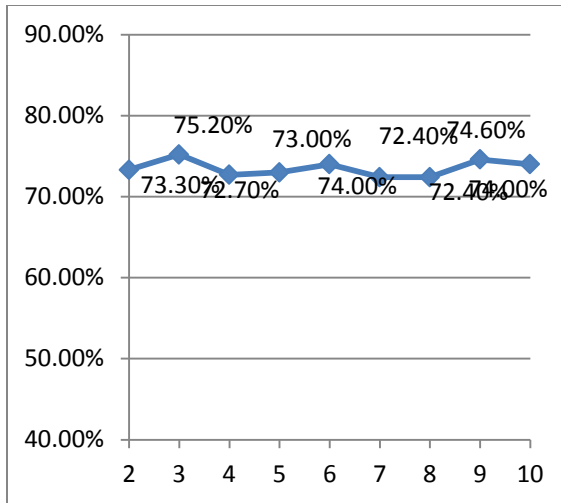

Figure 57: Male DP – HR Interview Session

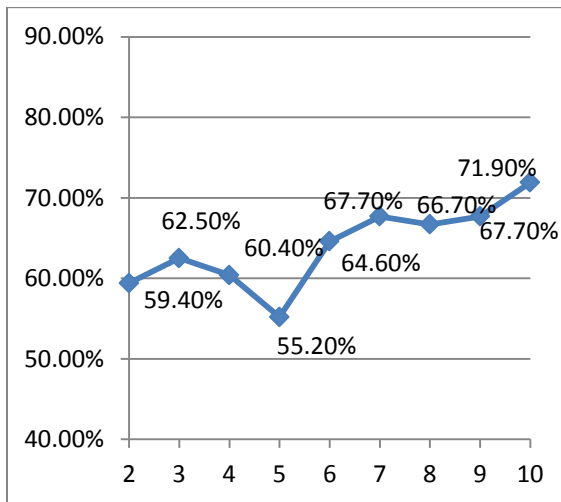

Figure 58: Male DP – HR Reading Session

For the reading session, 10 bands gave the best discriminating result with a classification rate of 71.90%; 7 bands and 9 bands gave the second best (67.70%); the third best discriminating result was taken from the 8 bands results (66.70%). The classification results for the different band numbers for the male DP-HR reading session are shown in Figure 58.

3.1.2.1.3 Quadratic Classification Results

Quadratic classification results are shown in Figure 59 for the interview session and in Figure 60 for the reading session. 3 bands gave the best discriminating result with a classification rate of 76.50%, 9 bands gave the second best (76.20%) and 10 bands gave the third best discriminating result (74.30%) for the interview session. For the reading session, 10 bands gave the best discriminating result with a classification rate of 78.10%, 7 bands gave the second best (72.90%). The third best discriminating result is 8 bands and 9 bands with a classification rate of 71.90%.

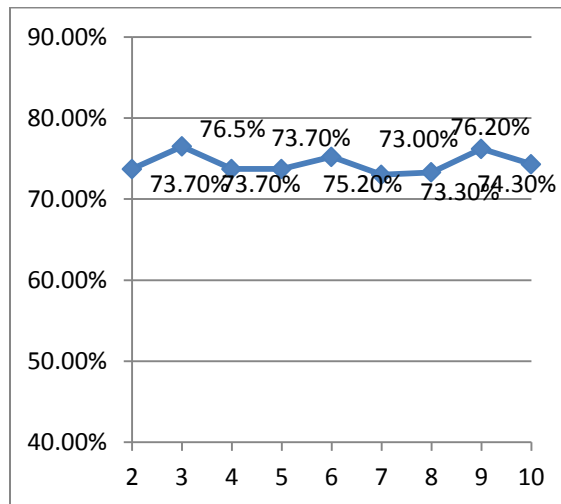

Figure 59: Male DP – HR Interview Session

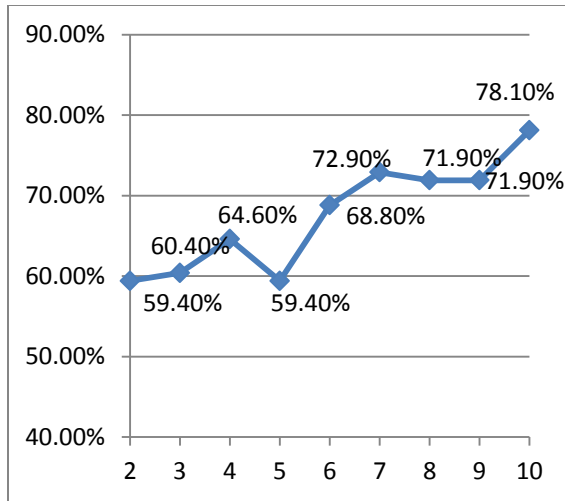

Figure 60: Male DP – HR Reading Session

3.1.2.2 Depressed & Remitted (DP – RM) Pairwise Group

3.1.2.2.1 Linear Classification Results

The DP-RM (Depressed-Remitted) pairwise group during the interview session was analyzed using the linear classification method and 8 bands gave the best discriminating result with a classification rate of 84.20%. 4 bands, 9 bands and 10 bands gave the second best (83.00%) result, and finally 6 bands gave the third best discriminating result (81.90%). Figure 61 shows the classification results for different band numbers for the male DP-RM interview session. For the reading session (using the linear classification method), 9 bands gave the best discriminating result with a classification rate of 75.80%. 6 bands and 10 bands gave the second best (74.70%); 4 bands and 8 bands gave the third best discriminating result (73.70%). Figure 62 shows the classification results for the different band numbers for the male DP-RM reading session.

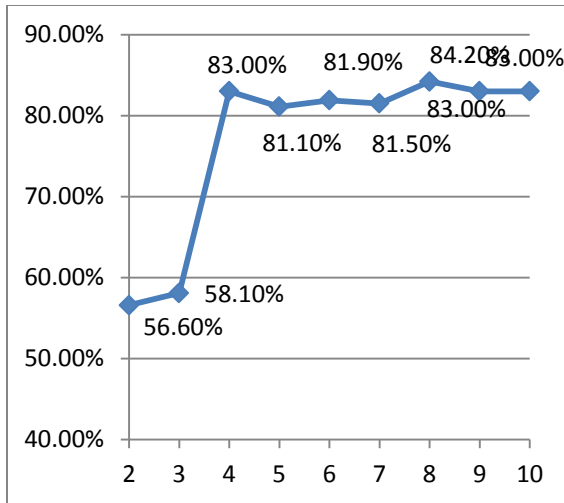

Figure 61: Male DP – RM Interview Session

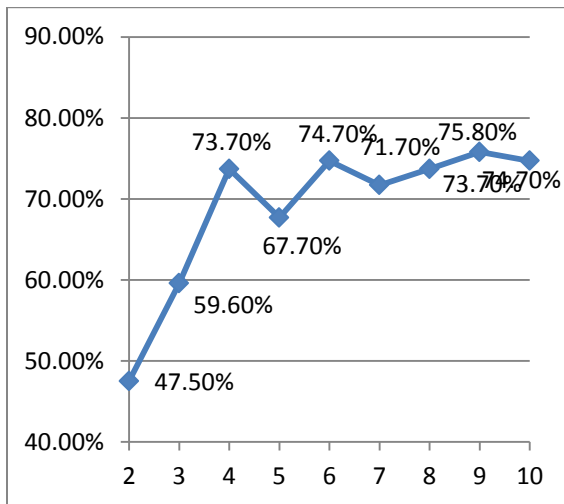

Figure 62: Male DP – RM Reading Session

3.1.2.2.2 Cross Validated Classification Results

The cross validated classification results are shown in Figure 63 for the interview session and in Figure 64 for the reading session. 4 bands and 8 bands gave the best discriminating result with a classification rate of 82.30%; 9 bands gave the second best (81.90%); and 7 bands and 10 bands gave the third best discriminating result (81.50%)

for the interview session. For the reading session, 6 bands gave the best discriminating result with a classification rate of 73.70%. 4 bands gave the second best (72.70%) result and finally the third best discriminating result is 10 bands with a classification rate of 69.70%.

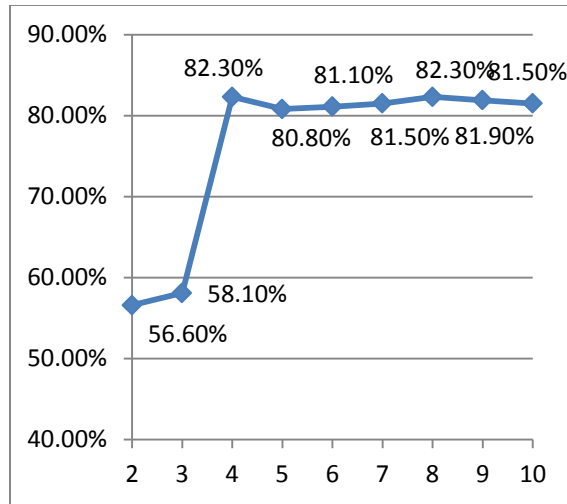

Figure 63: Male DP – RM Interview Session

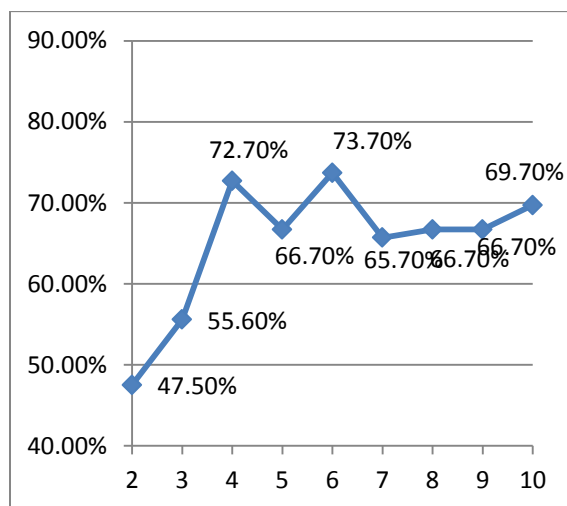

Figure 64: Male DP – RM Reading Session

3.1.2.2.3 Quadratic Classification Results

According to the quadratic discriminant classification, 9 bands gave the best discriminating result (84.50%), 8 bands gave the second best (83.80%) and 10 bands gave the third best discriminating result (83.40%) for the interview session. These results can be seen in Figure 65 below. For the reading session, 4 bands and 10 bands gave the best discriminating result with a classification rate of 75.80%; 6 bands and 9 bands gave the second best (73.70%). The third best discriminating result was taken from the 5 bands results (72.70%). The classification results for the different band numbers for the male DP – RM reading session is shown in Figure 66.

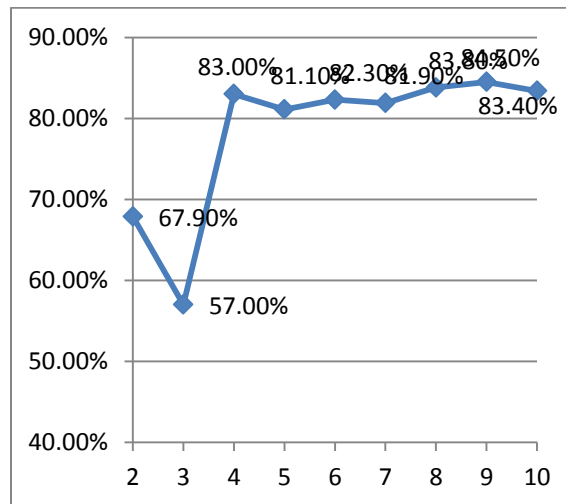

Figure 65: Male DP – RM Interview Session

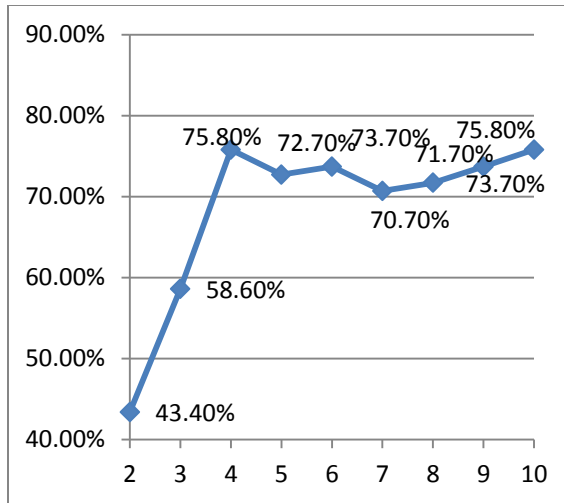

Figure 66: Male DP – RM Reading Session

3.1.2.3 High Risk Suicidal & Remitted (HR – RM) Pairwise Group

3.1.2.3.1 Linear Classification Results

In this part of the research, the High Risk Suicidal - Remitted (HR-RM) pairwise group for the male patients were studied. According to the linear classification, 9 bands and 10 bands gave the best discriminating result with a classification rate of 85.10%; 8 bands gave the second best (82.80%) and 3 bands gave the third best discriminating result (79.50%) for the interview session. Figure 67 shows the classification results for different band numbers for the male HR-RM interview session. For the reading session, 9 bands gave the best discriminating result with a classification rate of 81.90%, 6 bands gave the second best (78.30%) and 10 bands gave the third best discriminating result (75.90%). The classification results for different band numbers for the male HR-RM reading session is shown in Figure 68 below.

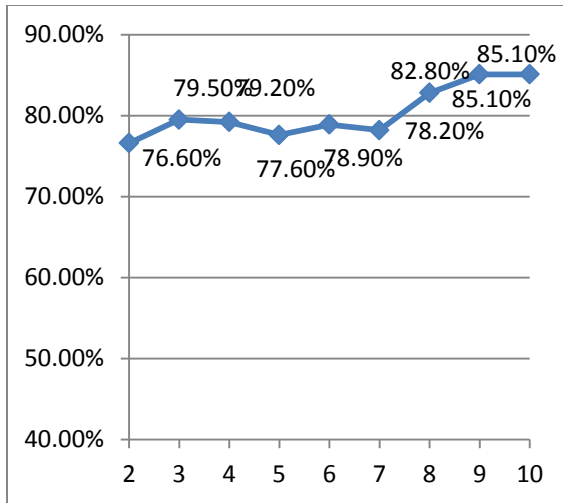

Figure 67: Male HR – RM Interview Session

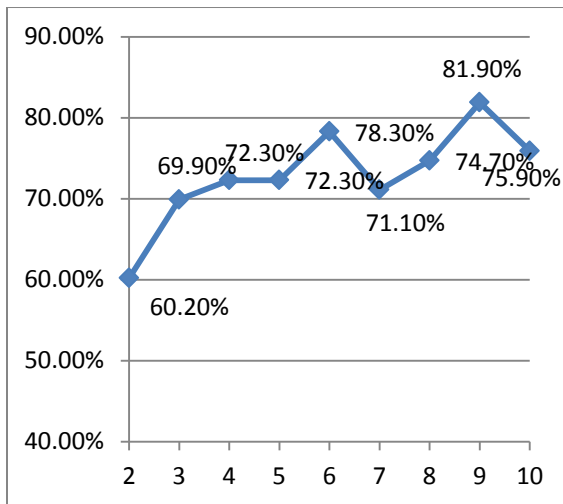

Figure 68: Male HR – RM Reading Session

3.1.2.3.2 Cross Validated Classification Results

The High Risk Suicidal – Remitted (HR-RM) pairwise group for the male patients were studied and according to the cross validated classification 9 bands gave the best discriminating result (84.40%), 10 bands gave the second best (84.10%) and 8 bands gave

the third best discriminating result (82.50%) for the interview session. These results can be seen in Figure 69 below.

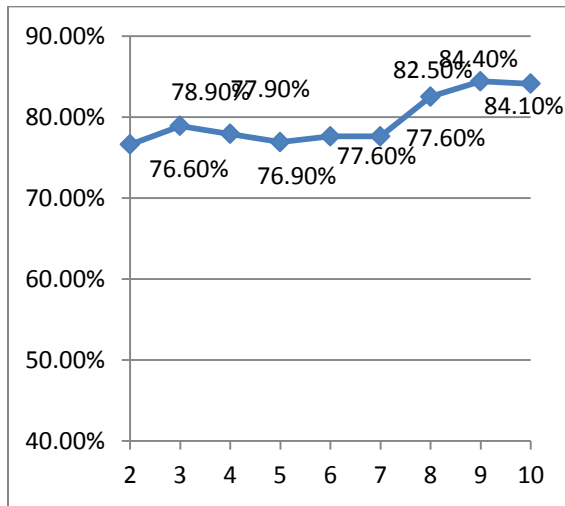

Figure 69: Male HR – RM Interview Session

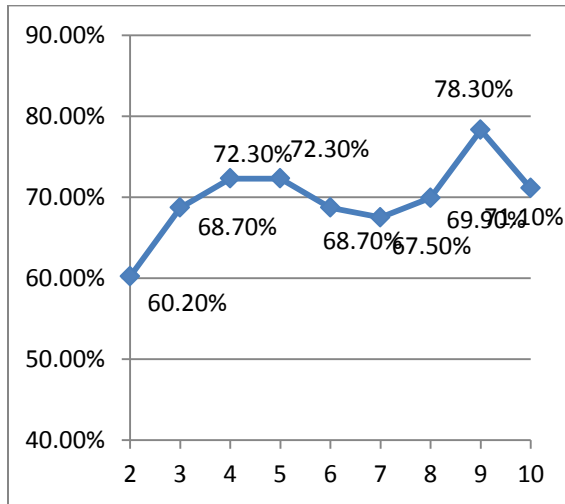

Figure 70: Male HR – RM Reading Session

For the reading session; 9 bands gave the best discriminating result with a classification rate of 78.30%; 4 bands and 5 bands gave the second best (72.30%). The third best discriminating result was taken from the 10 bands results (71.10%). The classification results for different band numbers for the male HR-RM reading session is shown in Figure 70 above.

3.1.2.3.3 Quadratic Classification Results

The quadratic classification results are shown in Figure 71 for the interview session and in Figure 72 for the reading session. 9 bands and 10 bands gave the best discriminating result with a classification rate of 85.10%, 8 bands gave the second best (82.80%) and 3 bands gave the third best discriminating result (79.50%) for the interview session. For the reading session, 9 bands gave the best discriminating result with a classification rate of 81.90%, 6 bands gave the second best (74.70%). The third best discriminating result is 10 bands and bands with a classification rate of 73.50%.

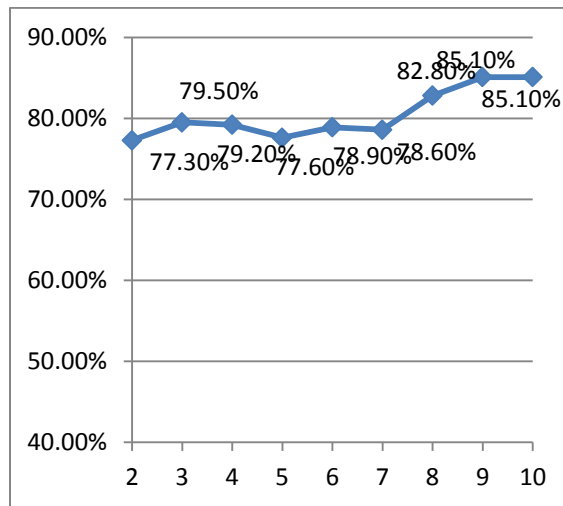

Figure 71: Male HR – RM Interview Session

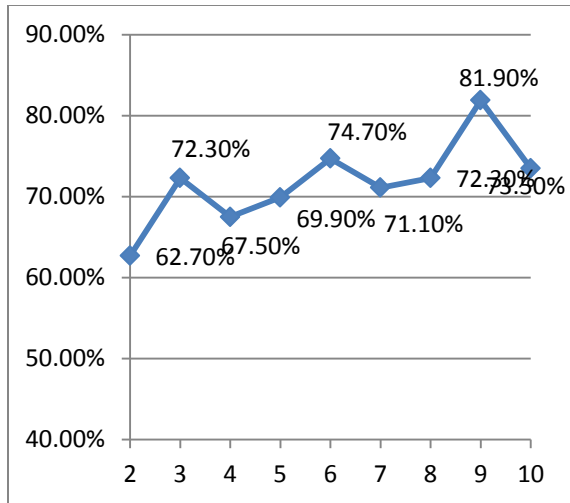

Figure 72: Male HR – RM Reading Session

Table 30 shows all the optimized band numbers (the best discriminating band/bands) of male patients for different pairwise groups (DP-HR, DP-RM, HR-RM) with different classification methods. The table also shows the classification rates for these optimized bands

Table 30: The Best Band Number Results for the Male Patients

	MALE PATIENTS (0 – 2000 Hz)					
<u>Pairwise Group</u>	<u>Optimized Band Numbers</u>			<u>Classification Rate</u>		
	Linear	Cross Validated	Quadratic	Linear	Cross Validated	Quadratic
DP – HR Interview	9 bands	3 bands	3 bands	75.90%	75.20%	76.50%
DP – HR Reading	10 bands	10 bands	10 bands	76.00%	71.90%	78.10
DP – RM Interview	8 bands	4 bands & 8 bands	9 bands	84.20%	82.30%	84.50%
DP – RM Reading	9 bands	6 bands	4 bands & 10 bands	75.80%	73.70%	75.80%
HR – RM Interview	9 bands & 10 bands	9 bands	9 bands & 10 bands	85.10%	84.40%	85.10%
HR – RM Reading	9 bands	9 bands	9 bands	81.90%	78.30%	81.90%

For the male patients, the quadratic classifier seems to be the best discriminant classifier for all pairwise groups (DP-HR, DP-RM, and HR-RM) and for both types of the speech samples (the interview session, and the reading session) for the 0 – 2000 Hz frequency range. For the DP-RM reading session, the HR-RM interview session and the HR-RM reading session; linear discriminant classifier also gave results similar to the quadratic discriminant classifier.

3 bands is the optimized band number for the DP-HR interview session with a classification rate of 76.50% and 10 bands is the optimized band number for the DP-HR reading session with a classification rate of 78.10%. For the DP-RM pairwise group, 9 bands give the best results for both sessions (84.50% for the interview session and 75.80% for the reading session). So, 9 bands is the optimized band number for both the DP-RM interview session and the DP-RM reading session. 4 bands and 10 bands also

gave the best results for the DP-RM reading sessions. 9 bands is also the optimized band number for the HR-RM pairwise group for both sessions. It gave 85.10% classification rate for the HR-RM interview session and 81.90% classification rate for the HR-RM reading session. For the HR-RM interview, 10 bands also gave the best results with an 85.10% classification rate.

3.1.3 Comparison of Classification Type

In this subchapter, the classification types that were used in this research will be compared. Three different types of classification method were used. They are the linear discriminant classifier, quadratic discriminant classifier and cross validated discriminant classifier which is the leave-one-out classification method. This sub-chapter will show the results of classification type comparisons.

3.1.3.1 Female Patients' Comparisons

When the classification type is compared for the Depressed – High Risk Suicidal (DP-HR) pairwise group for the female patients during the interview session, the quadratic classifier gave the best result for all of the bands except 3 bands. Figure 73 shows the results below.

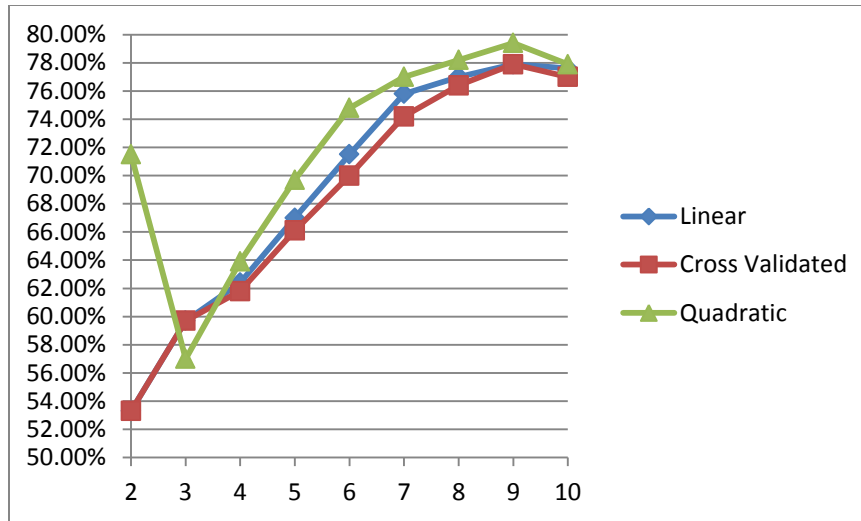

Figure 73: Female DP – HR Interview Session

Figure 74 shows the results for the Depressed – High Risk Suicidal (DP-HR) pairwise group for the female patients during the reading session. The linear classifier gave the best result for all of the bands except 2 bands.

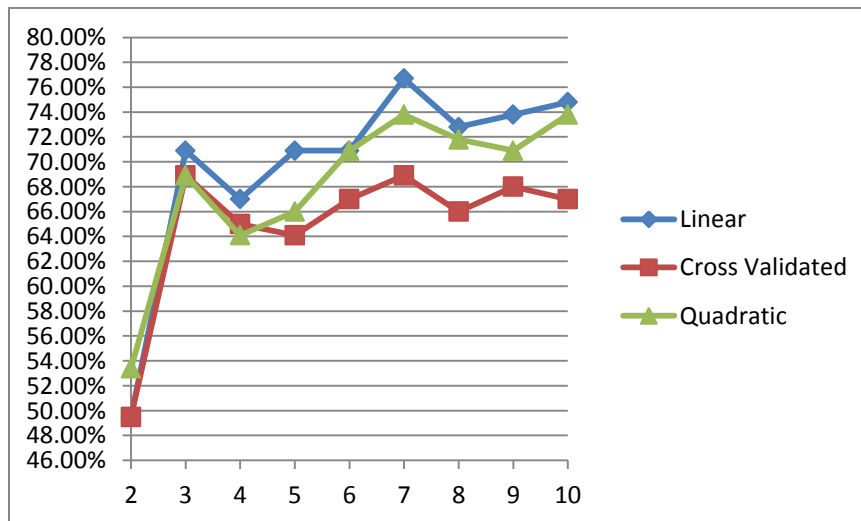

Figure 74: Female DP – HR Reading Session

Table 31 below shows all the results for the Depressed – High Risk Suicidal (DP-HR) pairwise group for the female patients during both sessions.

Table 31: The Best Classification Type Comparison Results for the DP – HR Pair of Female Patient

	Female DP - HR Interview	Female DP - HR Reading
Band #	0 - 2000 Hz	0 - 2000 Hz
2	Quadratic	Quadratic
3	Linear & Cross	Linear
4	Quadratic	Linear
5	Quadratic	Linear
6	Quadratic	Linear & Quadratic
7	Quadratic	Linear
8	Quadratic	Linear
9	Quadratic	Linear
10	Quadratic	Linear

The quadratic classifier gave the best result for all of the bands, when the classification type is compared for the Depressed – Remitted (DP-RM) pairwise group for the female patients during the interview session which is shown in Figure 75.

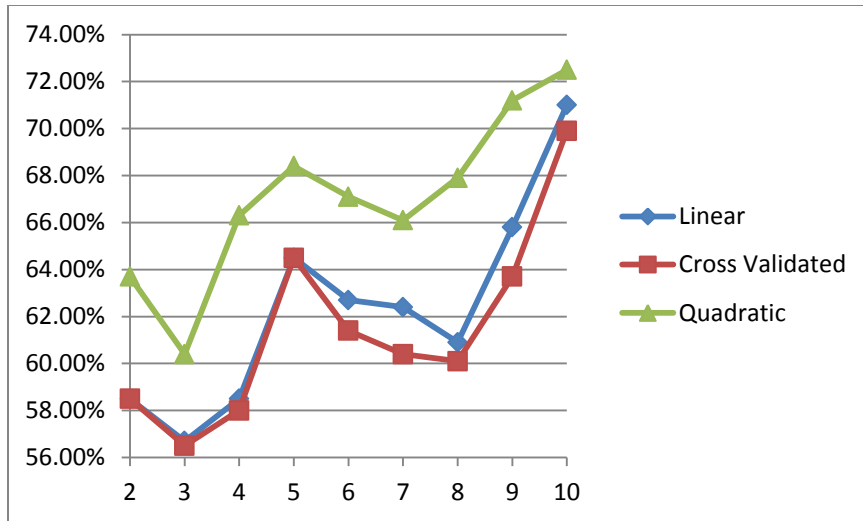

Figure 75: Female DP – RM Interview Session

Figure 76 shows the results for the Depressed – Remitted (DP-RM) pairwise group for the female patients during the reading session. The quadratic classifier gave the best result for 10 bands, 9 bands, 7 bands, 5 bands. The linear classifier gave the best result for 8 bands, 6 bands, 4 bands, 3 bands. For 2 bands, both the linear and the cross validated classifier gave good results.

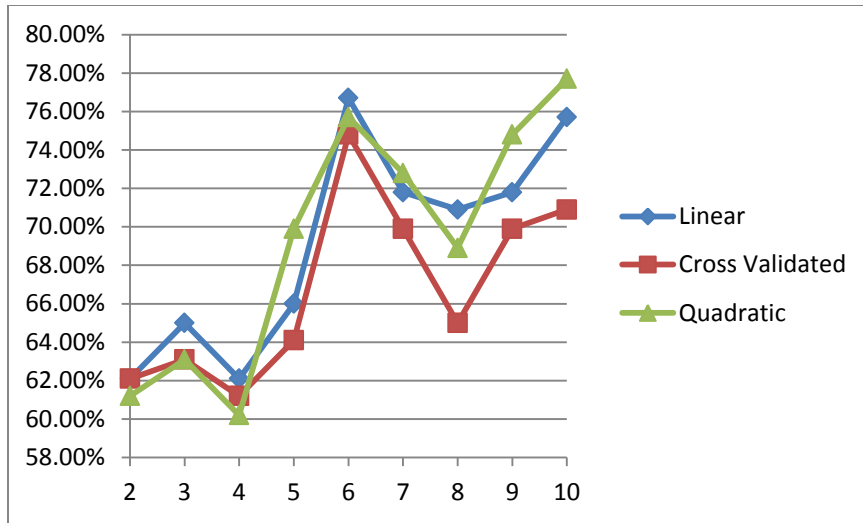

Figure 76: Female DP – RM Reading Session

The results for the Depressed – Remitted (DP-RM) pairwise group for the female patients during both sessions are shown in Table 32 below.

Table 32: The Best Classification Type Comparison Results for the DP – RM Pair of Female Patients

	Female DP - RM Interview	Female DP - RM Reading
Band #	0 - 2000 Hz	0 - 2000 Hz
2	Quadratic	Linear & Cross
3	Quadratic	Linear
4	Quadratic	Linear
5	Quadratic	Quadratic
6	Quadratic	Linear
7	Quadratic	Quadratic
8	Quadratic	Linear
9	Quadratic	Quadratic
10	Quadratic	Quadratic

Figure 77 shows the results for the High Risk Suicidal – Remitted (HR-RM) pairwise group for the female patients during the interview session. The linear classifier gave the best result for all bands except 2 bands. The quadratic classifier gave the best results for 8 bands, 7 bands, and 2 bands. The cross validated classifier gave good results for 6 bands, and 3 bands. All classifiers gave the same result for 5 bands.

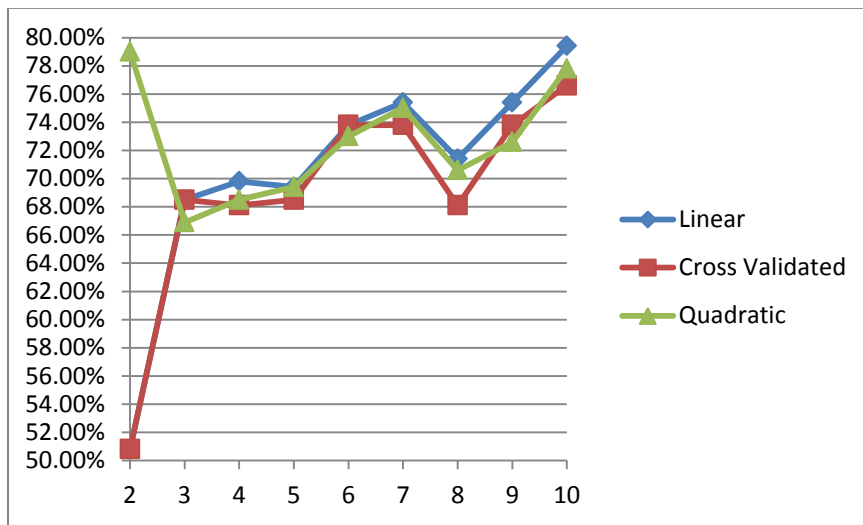

Figure 77: Female HR – RM Interview Session

The high Risk Suicidal – Remitted (HR-RM) pairwise group for the female patients during the reading session was analyzed and the results are shown in Figure 78. Both the linear and the quadratic classifier gave the best result for 10 bands, 8 bands, 7 bands, 6 bands, 5 bands. Only the linear classifier gave the best result for 9 bands, 4 bands, and 3 bands. Only the quadratic classifier gave the best result for 2 bands.

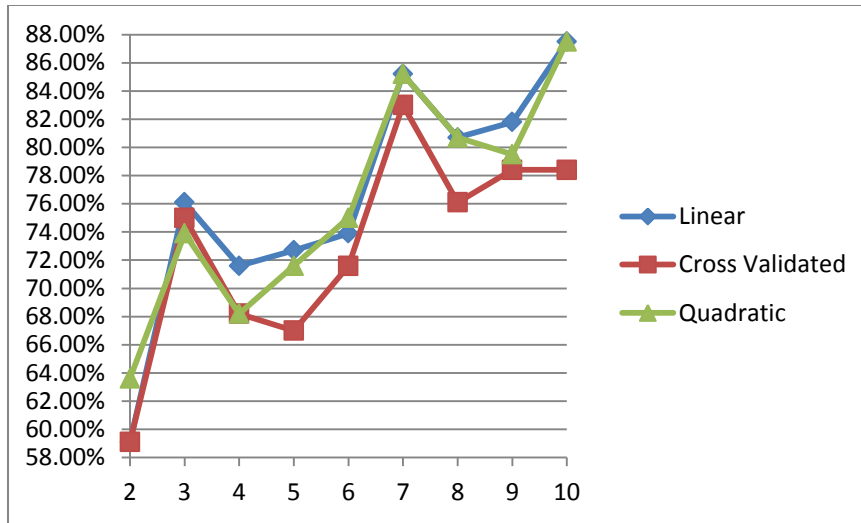

Figure 78: Female HR – RM Reading Session

The results for the High Risk Suicidal – Remitted (HR-RM) pairwise group for the female patients during both sessions are shown in Table 33 below.

Table 33: The Best Classification Type Comparison Results for the HR – RM Pair of Female Patients

	Female HR - RM Interview	Female HR - RM Reading
Band #	0 - 2000 Hz	0 - 2000 Hz
2	Quadratic	Quadratic
3	Linear & Cross	Linear
4	Linear	Linear
5	All best	Linear & Quadratic
6	Linear & Cross	Linear & Quadratic
7	Linear & Quadratic	Linear & Quadratic
8	Linear & Quadratic	Linear & Quadratic
9	Linear	Linear
10	Linear	Linear & Quadratic

3.1.3.2 Male Patients' Comparisons

When the classification type is compared for the Depressed – High Risk Suicidal (DP-HR) pairwise group for the male patients during the interview session, the quadratic classifier gave the best result for all of the bands as shown in Figure 79.

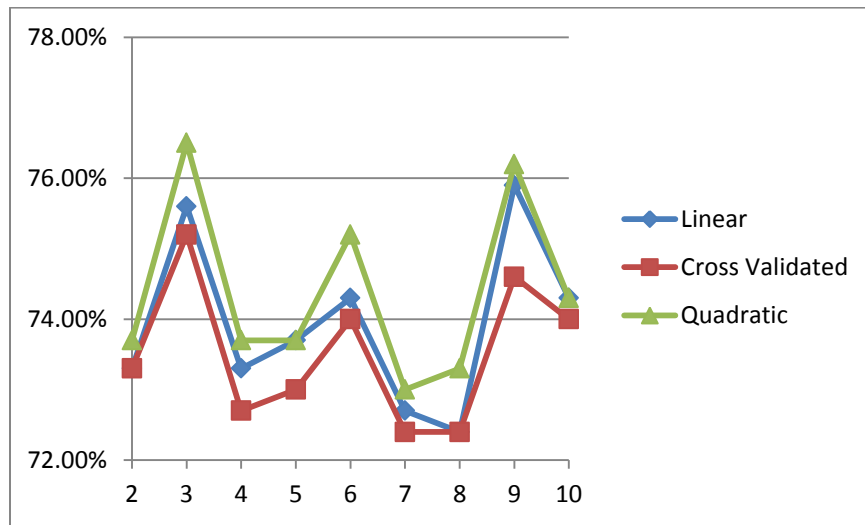

Figure 79: Male DP – HR Interview Session

Figure 80 shows the results for the Depressed – High Risk Suicidal (DP-HR) pairwise group for the male patients during the reading session. Quadratic classifier gave the best result for all of the bands except 3 bands. For 3 bands, both the linear and the cross validated classifiers gave the same good result. For 8 bands, both the linear and the quadratic classifiers gave the same good result. Finally, all three classifiers gave the best result for 2 bands.

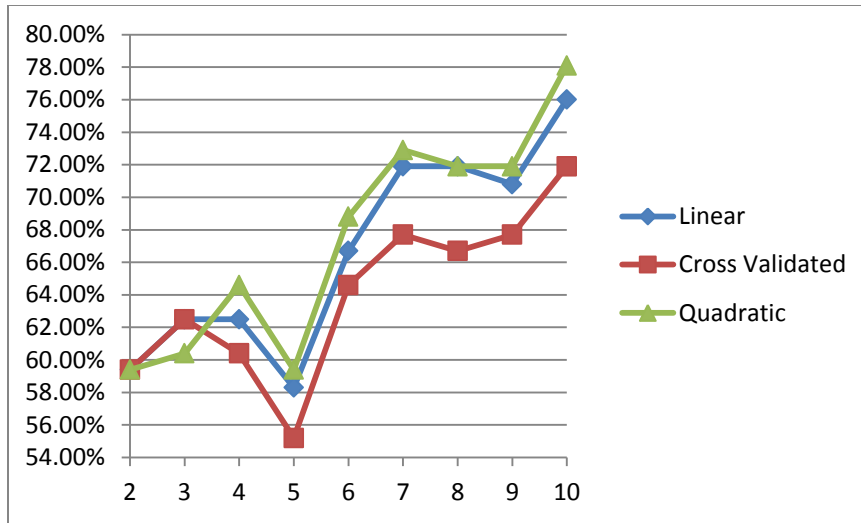

Figure 80: Male DP – HR Reading Session

Table 34 below shows all the results for the Depressed – High Risk Suicidal (DP-HR) pairwise group for the male patients during both sessions.

Table 34: The Best Classification Type Comparison Results for the DP – HR Pair of Male Patients

	Male DP - HR Interview	Male DP - HR Reading
Band #	0 - 2000 Hz	0 - 2000 Hz
2	Quadratic	All best
3	Quadratic	Linear & Cross
4	Quadratic	Quadratic
5	Quadratic	Quadratic
6	Quadratic	Quadratic
7	Quadratic	Quadratic
8	Quadratic	Linear & Quadratic
9	Quadratic	Quadratic
10	Quadratic	Quadratic

Quadratic classifier gave the best result for all of the bands except 3 bands, when the classification type is compared for the Depressed – Remitted (DP-RM) pairwise group for the male patients during the interview session which is shown in Figure 81. For 3 bands, linear and cross validated classifiers both gave same good classification result. All three classifiers gave the best result for 4 bands, 5 bands, and 7 bands. Linear classifiers also gave good results for 8 bands and 10 bands as well as the quadratic classifiers. Quadratic classifier gave good result 6 bands.

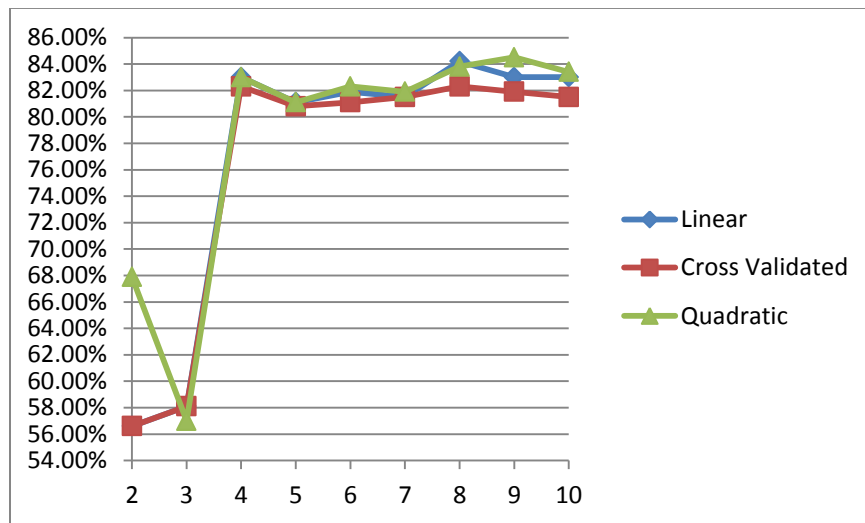

Figure 81: Male DP – RM Interview Session

Figure 82 shows the results for the Depressed – Remitted (DP-RM) pairwise group for the male patients during the reading session. Quadratic classifier gave the best result for 10 bands, 5 bands, and 4 bands. Linear classifier gave the best result for 9 bands, 8 bands,

and 7 bands. For 2 bands, both the linear and the cross validated classifier gave good results. For 3 bands, both the linear and the quadratic classifier gave good results. All three classifiers gave the best result for 6 bands.

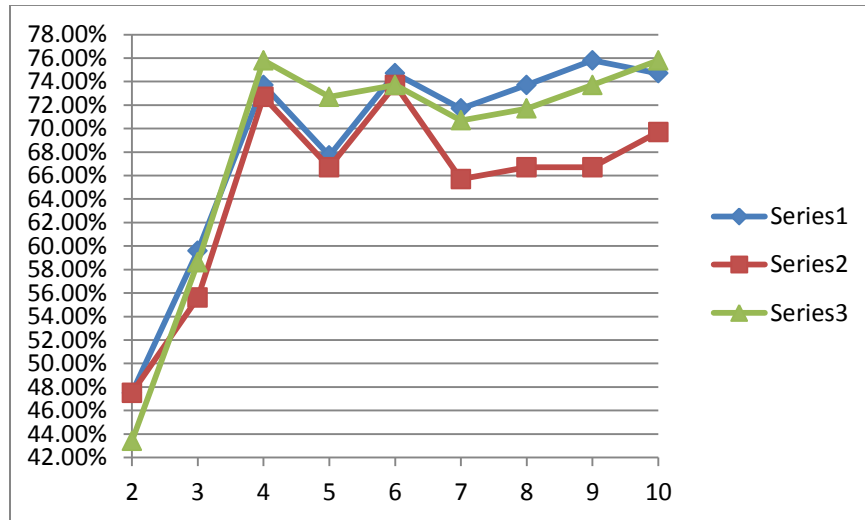

Figure 82: Male DP – RM Reading Session

The results for the Depressed – Remitted (DP-RM) pairwise group for the male patients during both sessions are shown in Table 35 below.

Table 35: The Best Classification Type Comparison Results for the DP – RM Pair of Male Patients

	Male DP - RM Interview	Male DP - RM Reading
Band #	0 - 2000 Hz	0 - 2000 Hz
2	Quadratic	Linear & Cross
3	Linear & Cross	Linear & Quadratic
4	All Best	Quadratic
5	All Best	Quadratic
6	Quadratic	All Best
7	All Best	Linear
8	Linear & Quadratic	Linear
9	Quadratic	Linear
10	Linear & Quadratic	Quadratic

Figure 83 shows the results for the High Risk Suicidal – Remitted (HR-RM) pairwise group for the male patients during the interview session. Quadratic classifier gave the best result for all bands. All classifiers gave the same result for 8 bands. Both the linear and the quadratic classifiers gave the best result for all bands except 2 bands and 7 bands.

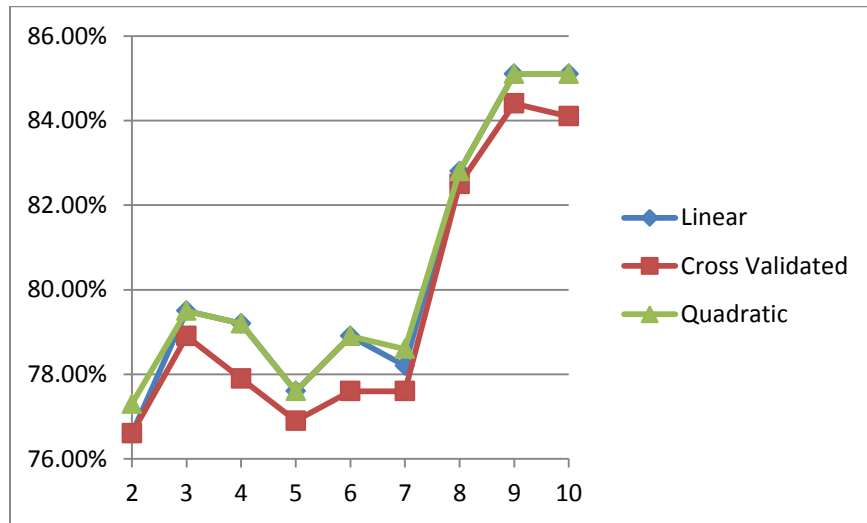

Figure 83: Male HR – RM Interview Session

High Risk Suicidal – Remitted (HR-RM) pairwise group for the male patients during the reading session was analyzed and the results are shown in Figure 84. Both the linear and the quadratic classifier gave the best result for 7 bands, 9 bands. Only the linear classifier gave the best result for 6 bands, 8 bands, and 10 bands. Only the quadratic classifier gave the best result for 2 bands and 3 bands. Both the linear and the cross validated classifier gave the best result for 4 bands, 5 bands.

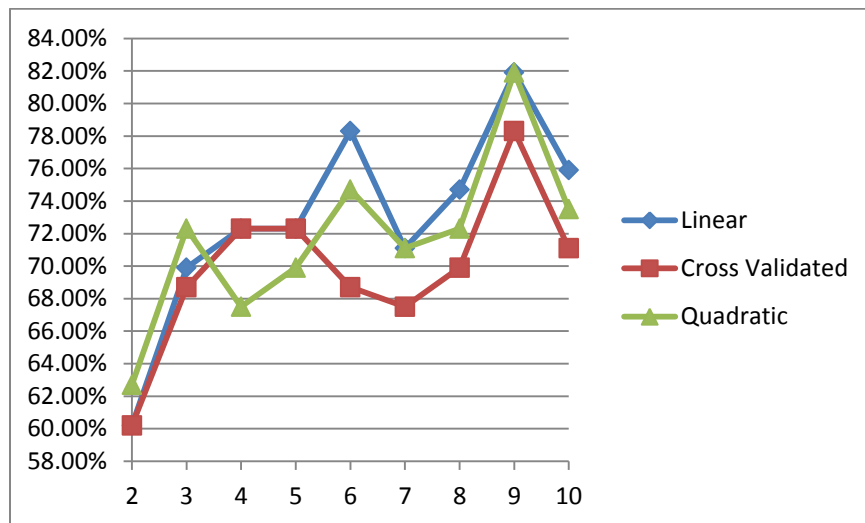

Figure 84: Male HR – RM Reading Session

The results for the High Risk Suicidal – Remitted (HR-RM) pairwise group for the male patients during both sessions are shown in Table 36 below.

Table 36: The Best Classification Type Comparison Results for the HR – RM Pair of Male Patient

	Male HR - RM Interview	Male HR - RM Reading
Band #	0 - 2000 Hz	0 - 2000 Hz
2	Quadratic	Quadratic
3	Linear & Quadratic	Quadratic
4	Linear & Quadratic	Linear & Cross
5	Linear & Quadratic	Linear & Cross
6	Linear & Quadratic	Linear
7	Quadratic	Linear & Quadratic
8	All Best	Linear
9	Linear & Quadratic	Linear & Quadratic
10	Linear & Quadratic	Linear

3.1.4 Comparison of Interview vs. Reading Sessions

Two different types of speech samples were used in this research. They are speech samples from the spontaneous speech during the clinical interview with a psychiatrist (interview session) and speech samples that was gathered while the patients were reading a predetermined part of a book named (reading session). This sub-chapter will show the results of different session comparisons.

3.1.4.1 Female Patients' Comparisons

When interview session and reading session is compared for the Depressed – High Risk Suicidal (DP-HR) pairwise group for the female patients using the linear classification, the interview session gave the best result for 10 bands, 9 bands, 8 bands, and 2 bands. Reading session gave the best result for 5 bands, 4 bands, and 3 bands. Both

sessions gave the same results for 6 bands and 7 bands. These results can be seen in Figure 85 below.

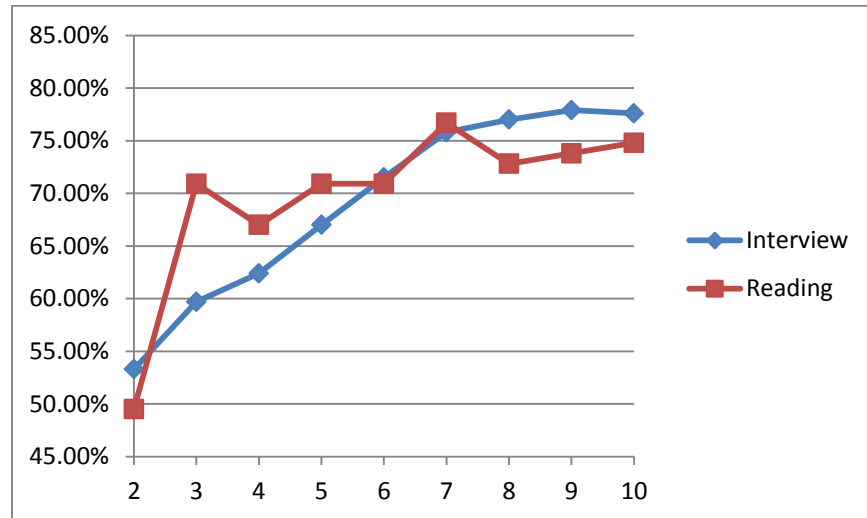

Figure 85: Female DP – HR Linear Classification

For the Depressed – High Risk Suicidal (DP-HR) pairwise group for the female patients using the cross validated classification; interview session gave the best result for all bands except 3 bands and 4 bands. These results can be seen in Figure 86 below.

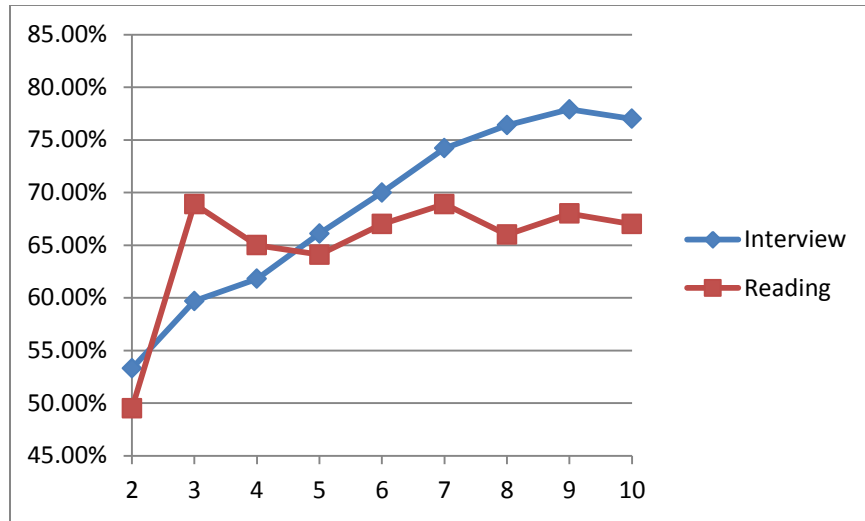

Figure 86: Female DP – HR Cross Validated Classification

For the Depressed – High Risk Suicidal (DP-HR) pairwise group for the female patients using the quadratic classification, interview session gave the best result for all bands except 3 bands. Both sessions gave the same best result for 4 bands. These results can be seen in Figure 87 below.

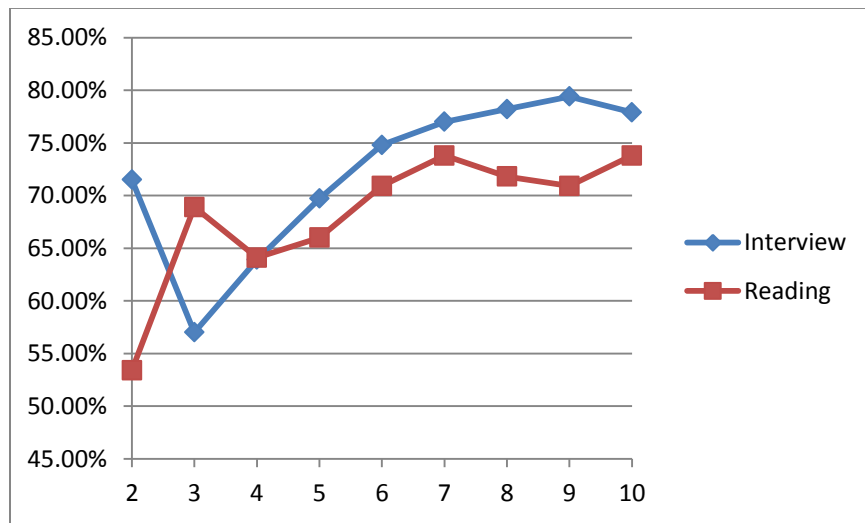

Figure 87: Female DP – HR Quadratic Classification

All of the results about different session comparisons are shown in Table 37 below for the Depressed – High Risk Suicidal (DP-HR) pairwise group for the female patients.

Table 37: Comparison of Interview vs. Reading Session Results for the DP – HR Pair of Female Patients

FEMALE DP - HR PAIR			
	Linear	Cross Validated	Quadratic
Band #	0 - 2000	0 - 2000	0 - 2000
2	Interview	Interview	Interview
3	Reading	Reading	Reading
4	Reading	Reading	Both best
5	Reading	Interview	Interview
6	Both best	Interview	Interview
7	Both best	Interview	Interview
8	Interview	Interview	Interview
9	Interview	Interview	Interview
10	Interview	Interview	Interview

When interview session and reading session is compared for the Depressed – Remitted (DP-RM) pairwise group for the female patients using the linear classification, reading session gave the best result for all results. These results can be seen in Figure 88 below.

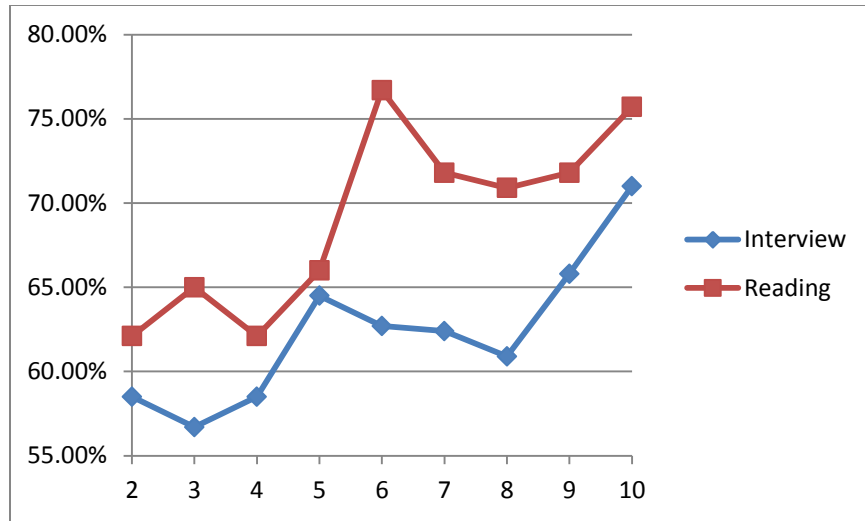

Figure 88: Female DP – RM Linear Classification

For the Depressed – Remitted (DP-RM) pairwise group for the female patients using the cross validated classification, reading session gave the best result for all bands. Both sessions gave the same best result for 5 bands. These results can be seen in Figure 89 below.

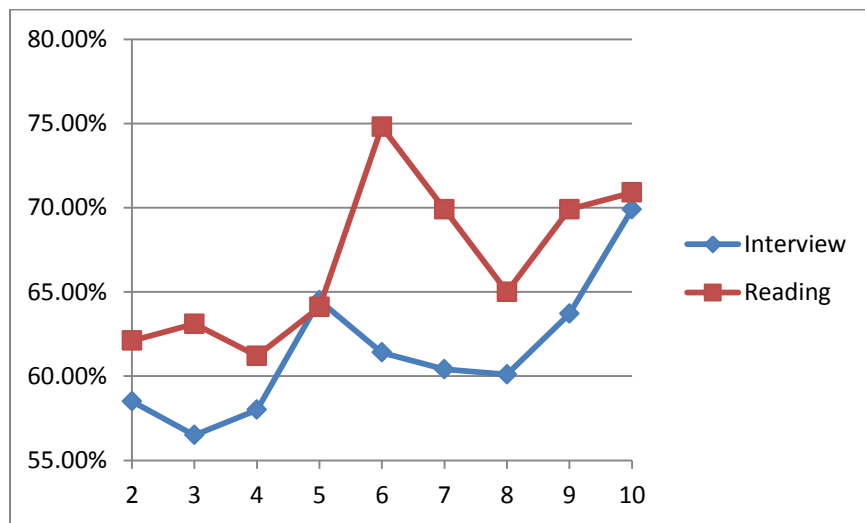

Figure 89: Female DP – RM Cross Validated Classification

For the Depressed – Remitted (DP-RM) pairwise group for the female patients using the quadratic classification, reading session gave the best result for all bands except 2 bands and 4 bands. These results can be seen in Figure 90 below.

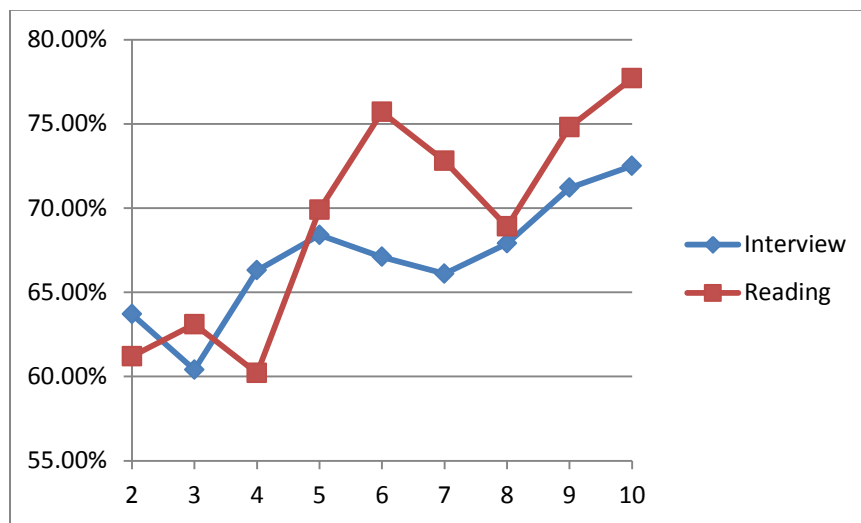

Figure 90: Female DP – RM Quadratic Classification

All of the results about different session comparisons are shown in Table 38 below for the Depressed – Remitted (DP-RM) pairwise group for the female patients.

Table 38: Comparison of Interview vs. Reading Session Results for the DP – RM Pair of Female Patients

FEMALE DP - RM PAIR			
	Linear	Cross Validated	Quadratic
Band #	0 - 2000	0 - 2000	0 - 2000
2	Reading	Reading	Interview
3	Reading	Reading	Reading
4	Reading	Reading	Interview
5	Reading	Both best	Reading
6	Reading	Reading	Reading
7	Reading	Reading	Reading
8	Reading	Reading	Reading
9	Reading	Reading	Reading
10	Reading	Reading	Reading

When interview session and reading session is compared for the High Risk Suicidal – Remitted (HR-RM) pairwise group for the female patients using the linear classification, reading session gave the best result for all results. Both sessions gave the same best result for 6 bands. These results can be seen in Figure 91 below.

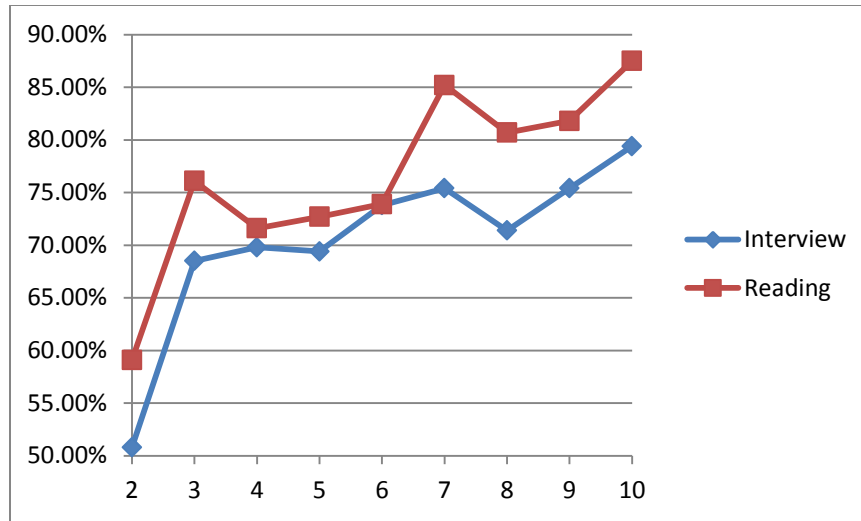

Figure 91: Female HR – RM Linear Classification

For the High Risk Suicidal – Remitted (HR-RM) pairwise group for the female patients using the cross validated classification, reading session gave the best result for all bands except 5 bands and 6 bands. Both sessions gave the same best result for 4 bands. These results can be seen in Figure 92 below.

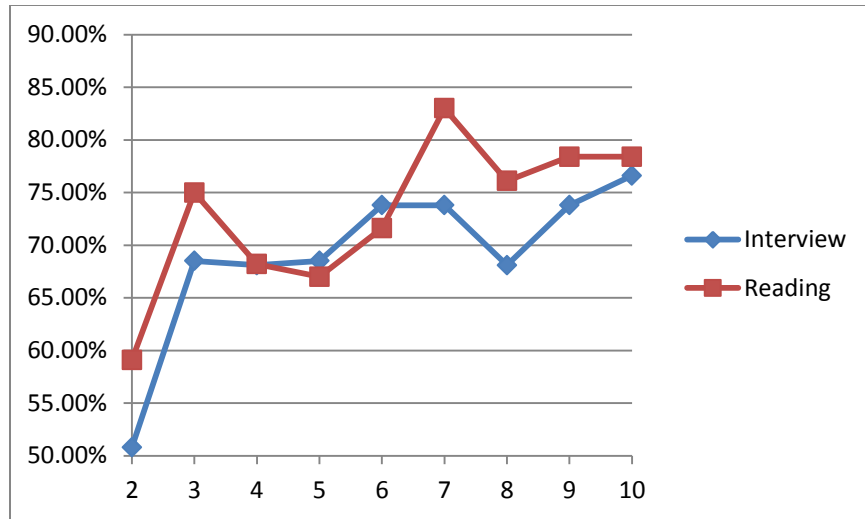

Figure 92: Female HR – RM Cross Validated Classification

For the High Risk Suicidal – Remitted (HR-RM) pairwise group for the female patients using the quadratic classification, reading session gave the best result for all bands. Interview session gave the same best result for 2 bands and 4 bands. These results can be seen in Figure 93 below.

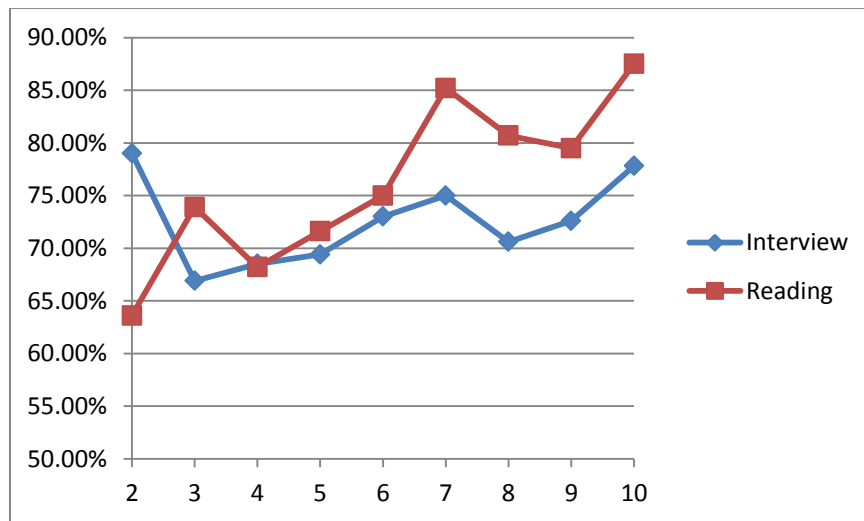

Figure 93: Female HR – RM Quadratic Classification

All of the results about different session comparisons are shown in Table 39 below for the High Risk Suicidal – Remitted (HR-RM) pairwise group for the female patients.

Table 39: Comparison of Interview vs. Reading Session Results for the HR – RM Pair of Female Patients

FEMALE HR - RM PAIR			
	Linear	Cross Validated	Quadratic
Band #	0 - 2000	0 - 2000	0 - 2000
2	Reading	Reading	Interview
3	Reading	Reading	Reading
4	Reading	Both best	Interview
5	Reading	Interview	Reading
6	Both best	Interview	Reading
7	Reading	Reading	Reading
8	Reading	Reading	Reading
9	Reading	Reading	Reading
10	Reading	Reading	Reading

3.1.4.2 Male Patients' Comparisons

When interview session and reading session is compared for the Depressed – High Risk Suicidal (DP-HR) pairwise group for the male patients using the linear classification, interview session gave the best result for all bands except 10 bands. Both sessions gave the same results for 7 bands and 8 bands. These results can be seen in Figure 94 below.

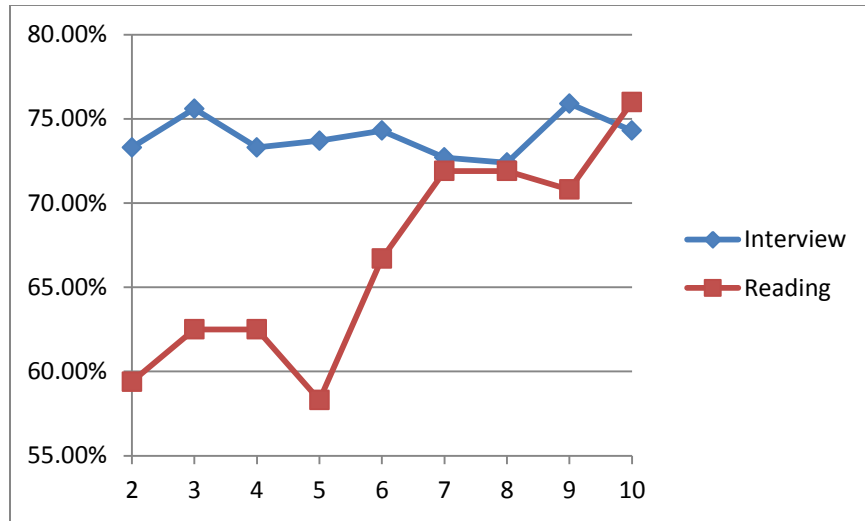

Figure 94: Male DP – HR Linear Classification

For the Depressed – High Risk Suicidal (DP-HR) pairwise group for the male patients using the cross validated classification; interview session gave the best result for all bands. These results can be seen in Figure 95 below.

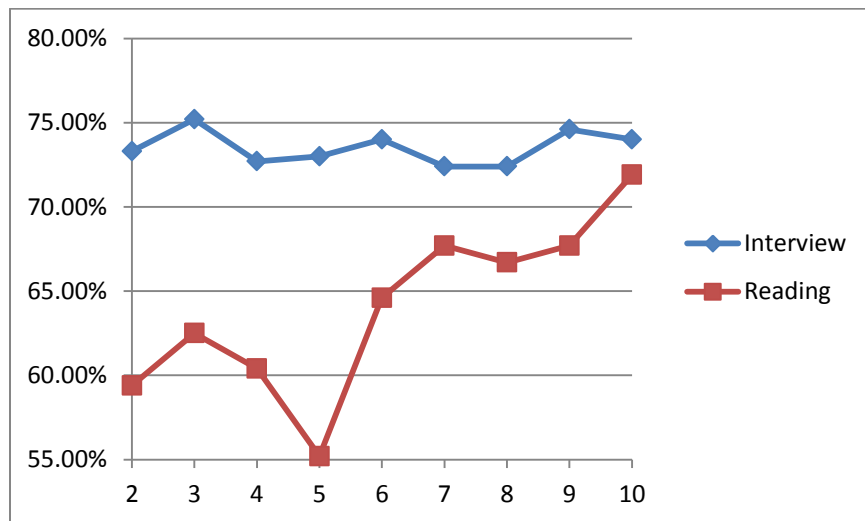

Figure 95: Male DP – HR Cross Validated Classification

For the Depressed – High Risk Suicidal (DP-HR) pairwise group for the male patients using the quadratic classification, interview session gave the best result for all bands except 10 bands. Both sessions gave the same best result for 7 bands. These results can be seen in Figure 96 below.

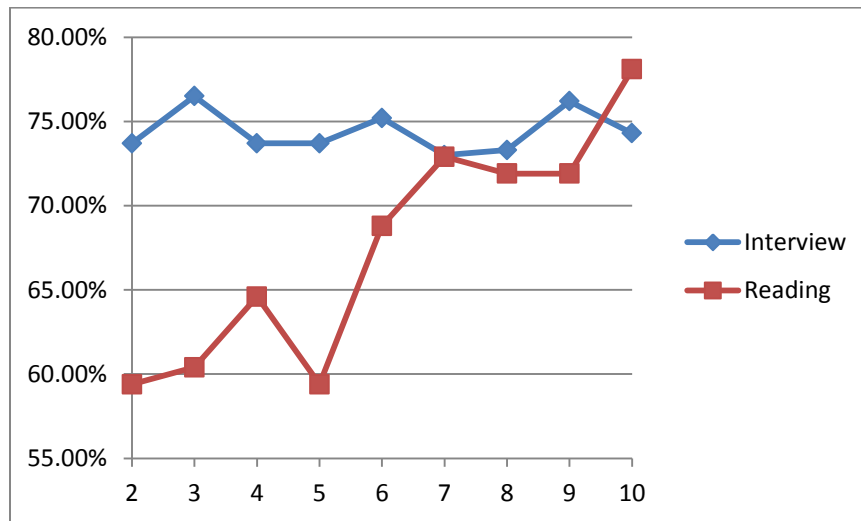

Figure 96: Male DP – HR Quadratic Classification

All of the results about different session comparisons are shown in Table 40 below for the Depressed – High Risk Suicidal (DP-HR) pairwise group for the male patients.

Table 40: Comparison of Interview vs. Reading Session Results for the DP – HR Pair of Male Patients

MALE DP - HR PAIR			
	Linear	Cross Validated	Quadratic
Band #	0 - 2000	0 - 2000	0 - 2000
2	Interview	Interview	Interview
3	Interview	Interview	Interview
4	Interview	Interview	Interview
5	Interview	Interview	Interview
6	Interview	Interview	Interview
7	Both Best	Interview	Both Best
8	Both Best	Interview	Interview
9	Interview	Interview	Interview
10	Reading	Interview	Reading

When interview session and reading session is compared for the Depressed – Remitted (DP-RM) pairwise group for the male patients using the linear classification, interview session gave the best result for all results except 3 bands. For this band, the classification rate was about same for both sessions but reading session is slightly better. These results can be seen in Figure 97 below.

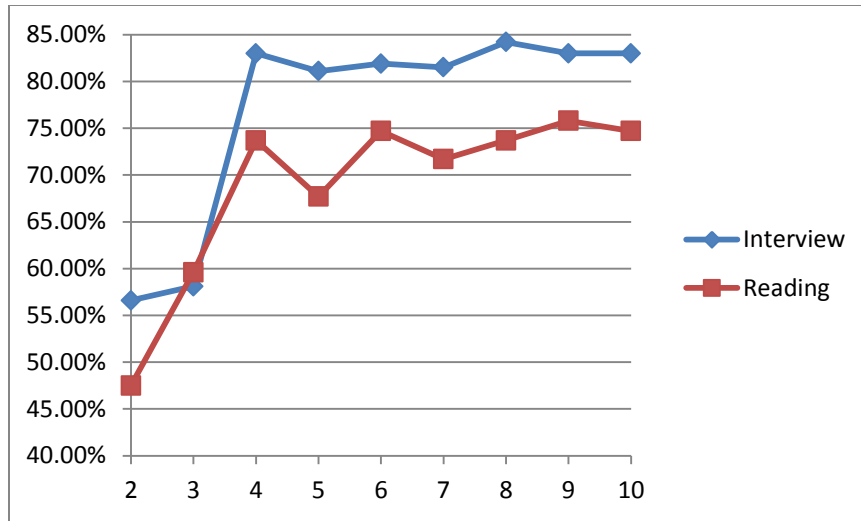

Figure 97: Male DP – RM Linear Classification

For the Depressed – Remitted (DP-RM) pairwise group for the male patients using the cross validated classification; interview session gave the best result for all bands. These results can be seen in Figure 98 below.

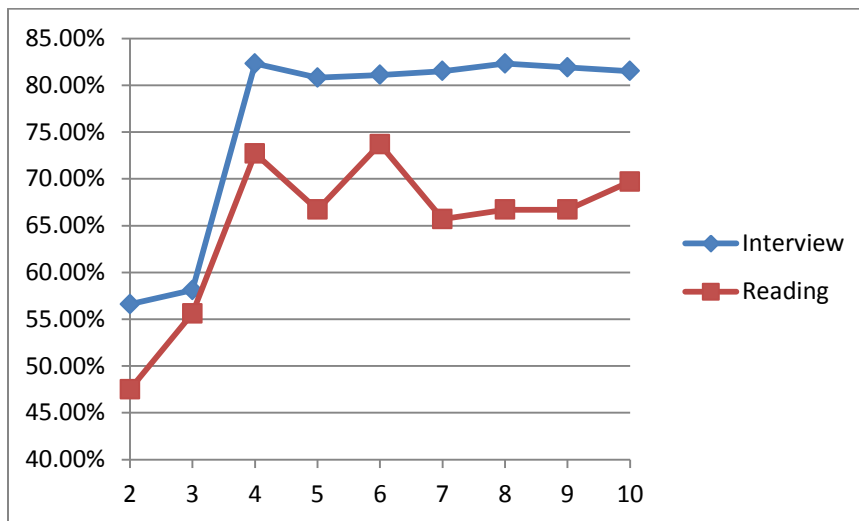

Figure 98: Male DP – RM Cross Validated Classification

For the Depressed – Remitted (DP-RM) pairwise group for the male patients using the quadratic classification, interview session gave the best result for all bands except 3 bands. For this band, the classification rate was about same for both sessions but the reading session is slightly better. These results can be seen in Figure 99 below.

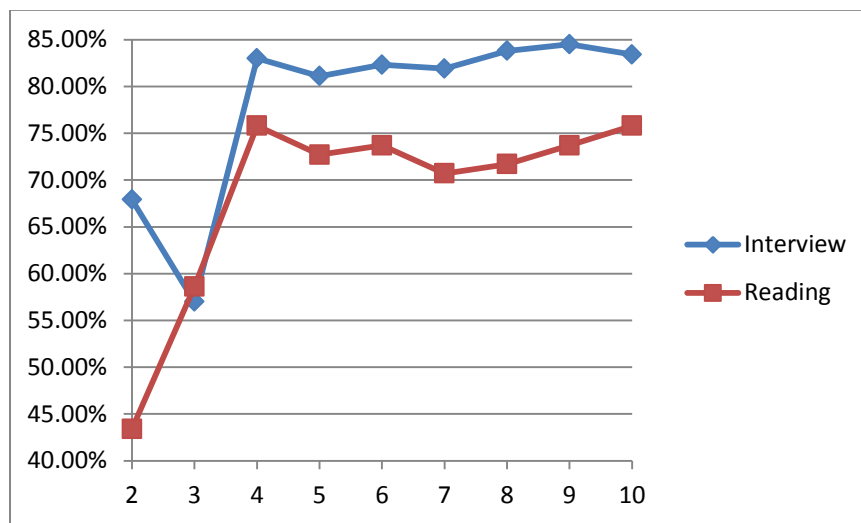

Figure 99: Male DP – RM Quadratic Classification

All of the results about different session comparisons are shown in Table 41 below for the Depressed – Remitted (DP-RM) pairwise group for the male patients.

Table 41: Comparison of Interview vs. Reading Session Results for the DP – RM Pair of Male Patient

MALE DP - RM PAIR			
	Linear	Cross Validated	Quadratic
Band #	0 - 2000	0 - 2000	0 - 2000
2	Interview	Interview	Interview
3	About same but Reading	About same but Interview	About same but Reading
4	Interview	Interview	Interview
5	Interview	Interview	Interview
6	Interview	Interview	Interview
7	Interview	Interview	Interview
8	Interview	Interview	Interview
9	Interview	Interview	Interview
10	Interview	Interview	Interview

When interview session and reading session is compared for the High Risk Suicidal – Remitted (HR-RM) pairwise group for the male patients using the linear classification, interview session gave the best result for all results. Both sessions gave the same best result for 6 bands. These results can be seen in Figure 100 below.

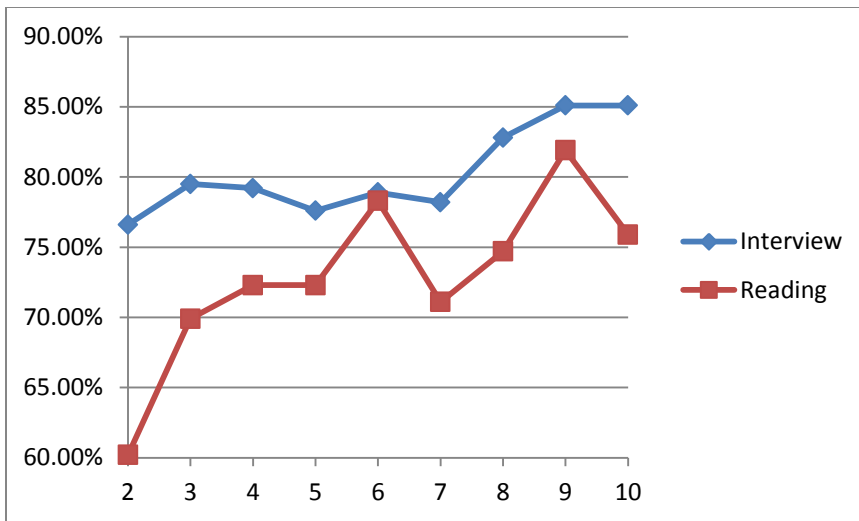

Figure 100: Male HR – RM Linear Classification

For the High Risk Suicidal – Remitted (HR-RM) pairwise group for the male patients using the cross validated classification; interview session gave the best result for all bands. These results can be seen in Figure 101 below.

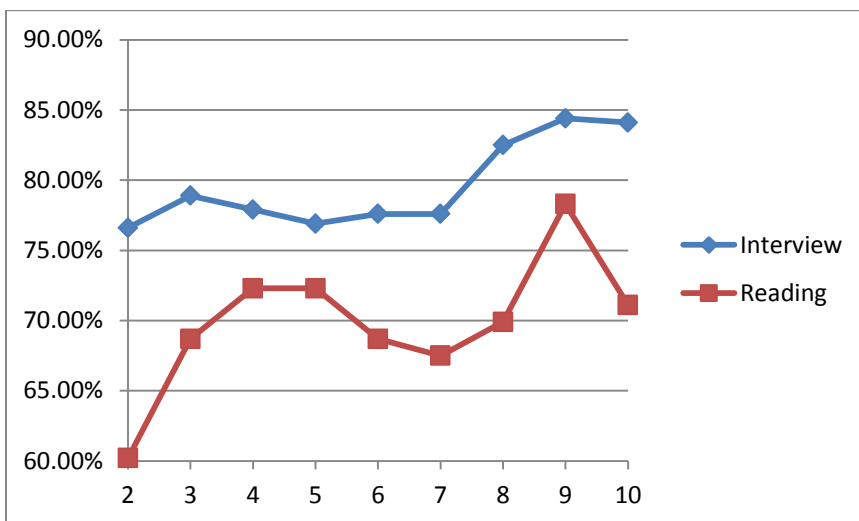

Figure 101: Male HR – RM Cross Validated Classification

For the High Risk Suicidal – Remitted (HR-RM) pairwise group for the male patients using the quadratic classification, interview session gave the best result for all bands.

These results can be seen in Figure 102 below.

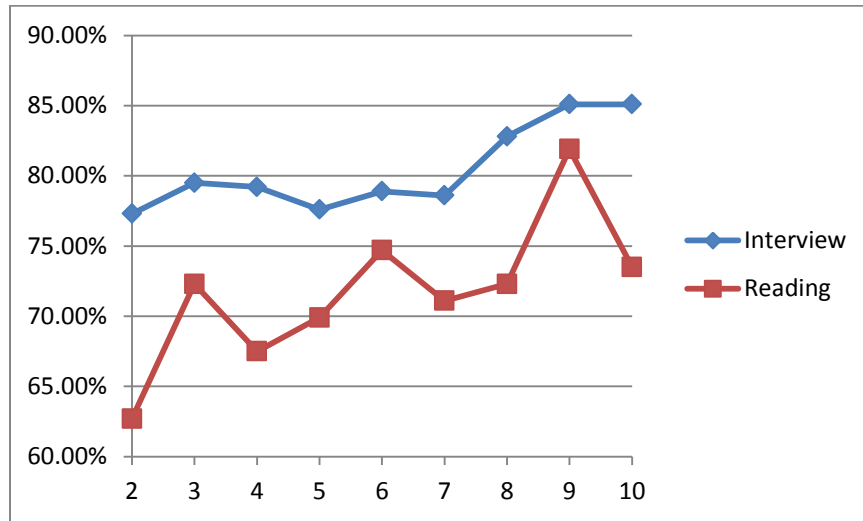

Figure 102: Male HR – RM Quadratic Classification

All of the results about different session comparisons are shown in Table 42 below for the High Risk Suicidal – Remitted (HR-RM) pairwise group for the male patients.

Table 42: Comparison of Interview vs. Reading Session Results for the HR – RM Pair of Male Patients

MALE HR - RM PAIR			
	Linear	Cross Validated	Quadratic
Band #	0 - 2000	0 - 2000	0 - 2000
2	Interview	Interview	Interview
3	Interview	Interview	Interview
4	Interview	Interview	Interview
5	Interview	Interview	Interview
6	Both best	Interview	Interview
7	Interview	Interview	Interview
8	Interview	Interview	Interview
9	Interview	Interview	Interview
10	Interview	Interview	Interview

3.1.5 Comparison of Pairwise Groups

In this subchapter, three different types of pairwise groups are compared. They are Depressed – High Risk Suicidal (DP-HR), Depressed – Remitted (DP-RM), High Risk Suicidal – Remitted (HR-RM). Depressed patients (DP) are the people who were diagnosed with depression, High Risk Suicidal patients (HR) are the people who were diagnosed with high risk suicide, and Remitted patients (RM) are the people who were diagnosed with remission from the depression. This part of the paper will show the results of different pairwise groups’ comparisons.

3.1.5.1 Female Patients’ Pairwise Group Comparisons

When the pairwise groups were compared for the female interview session with using the linear classification, HR-RM pairwise group gave the best classification rates for all bands except 2 bands, 8 bands and 9 bands. DP- HR pairwise group gave the best

classification rates for 8 bands, 9 bands and 7 bands. Finally, DP-RM pairwise group gave the best classification rate for 2 bands. These results can be seen in Figure 103 below.

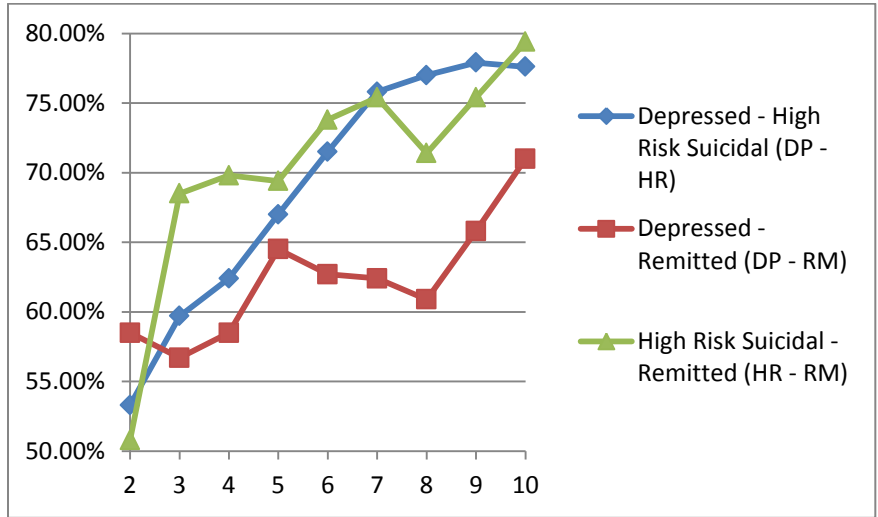

Figure 103: Female Interview Session with Linear Classification

When the pairwise groups were compared for the female interview session with using the cross validated classification, HR-RM pairwise group gave the best classification rates for all bands except 2 bands, 8 bands and 9 bands. DP- HR pairwise group gave the best classification rates for 7 bands, 8 bands, 9 bands and 10 bands. Finally, DP-RM pairwise group gave the best classification rate for 2 bands. These results can be seen in Figure 104 below.

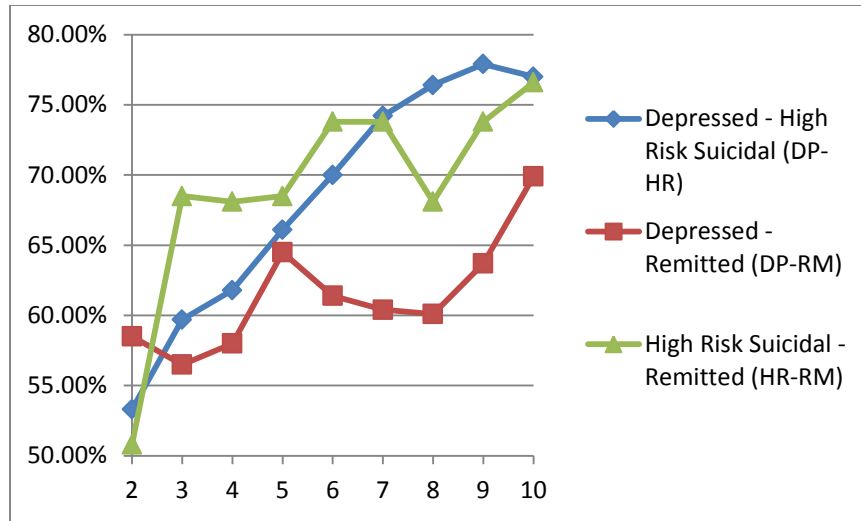

Figure 104: Female Interview Session with Cross Validated Classification

When the pairwise groups were compared for the female interview session with using the quadratic classification, HR-RM pairwise group gave the best classification rates mostly for the lower number of bands (2 bands, 3 bands, 4 bands, and 10 bands). DP- HR pairwise group gave the best classification rates for the higher number of bands (6 bands, 7 bands, 8 bands, 9 bands and 10 bands). Finally, all pairwise groups gave the best classification rate for 5 bands. These results can be seen in Figure 105 below.

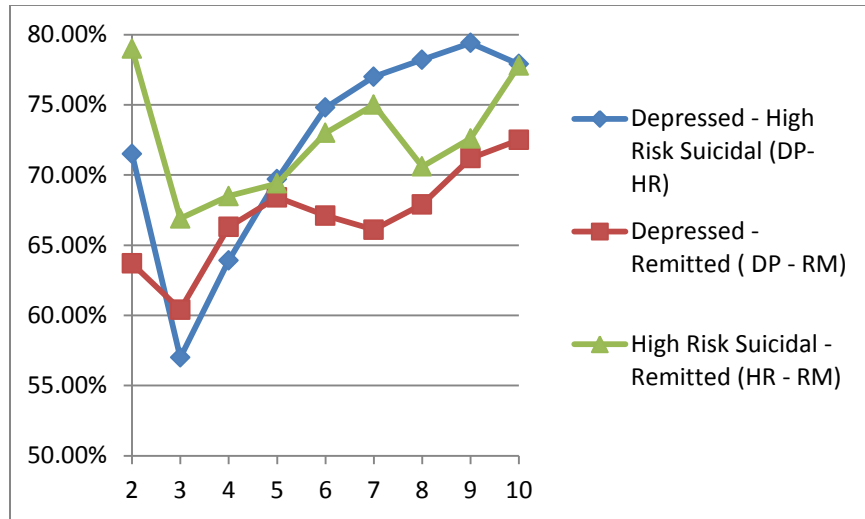

Figure 105: Female Interview Session with Quadratic Classification

All of the results about different pairwise groups' comparisons are shown in Table 43 below for the female interview session.

Table 43: Comparison of Pairwise Groups for the Female Patients Interview Session

FEMALE INTERVIEW			
	Linear	Cross Validated	Quadratic
Band #	0 - 2000	0 - 2000	0 - 2000
2	DP - RM	DP - RM	HR - RM
3	HR - RM	HR - RM	HR - RM
4	HR - RM	HR - RM	HR - RM
5	HR - RM	HR - RM	All Same
6	HR - RM	HR - RM	DP - HR
7	HR - RM & DP- HR	DP - HR & HR - RM	DP - HR
8	DP - HR	DP - HR	DP - HR
9	DP - HR	DP - HR	DP - HR
10	HR - RM	DP - HR & HR - RM	DP - HR & HR - RM

When the pairwise groups were compared for the female reading session with using the linear classification, HR-RM pairwise group gave the best classification rates for all bands except 2 bands, 6 bands. DP- RM pairwise group gave the best classification rates for 2 bands, and 6 bands. These results can be seen in Figure 106 below.

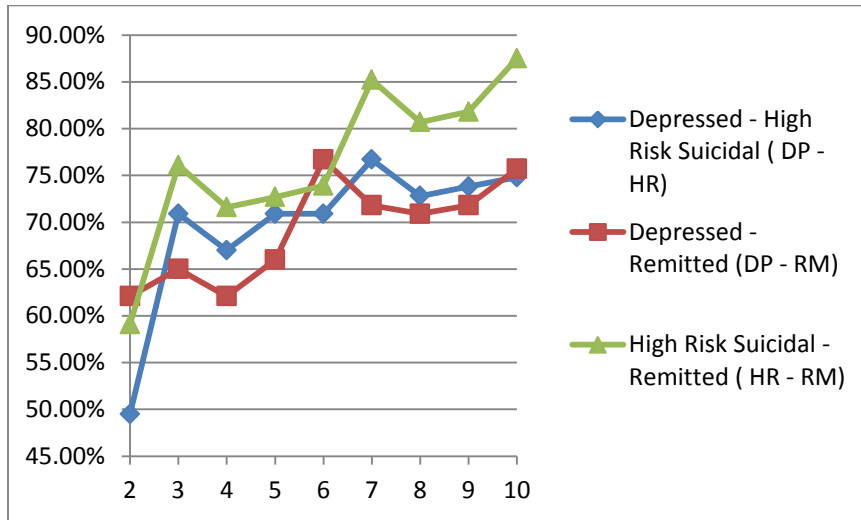

Figure 106: Female Reading Session with Linear Classification

When the pairwise groups were compared for the female reading session with using the cross validated classification, HR-RM pairwise group gave the best classification rates for all bands except 2 bands and 6 bands. DP-RM pairwise group gave the best classification rate for 2 bands and 6 bands. These results can be seen in Figure 107 below.

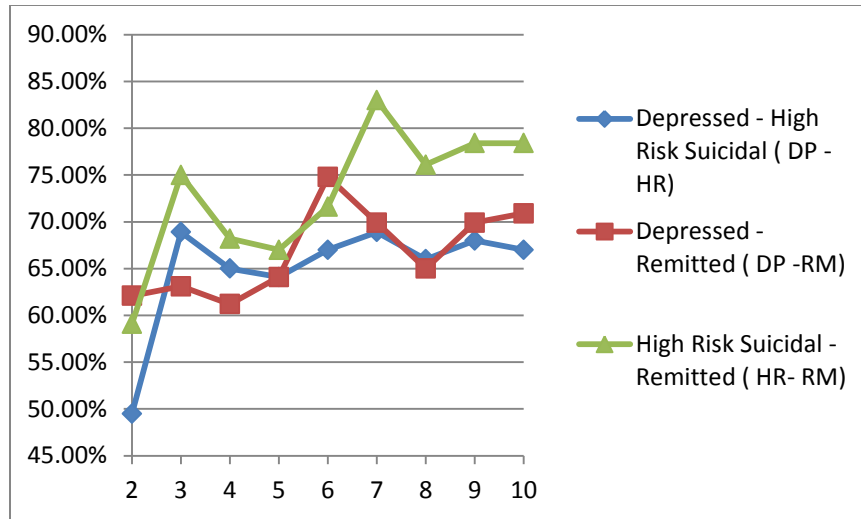

Figure 107: Female Reading Session with Cross Validated Classification

When the pairwise groups were compared for the female reading session with using the quadratic classification, HR-RM pairwise group gave the best classification rates for all bands. DP-RM pairwise group also gave the best classification rate for 5 bands and 6 bands. These results can be seen in Figure 108 below.

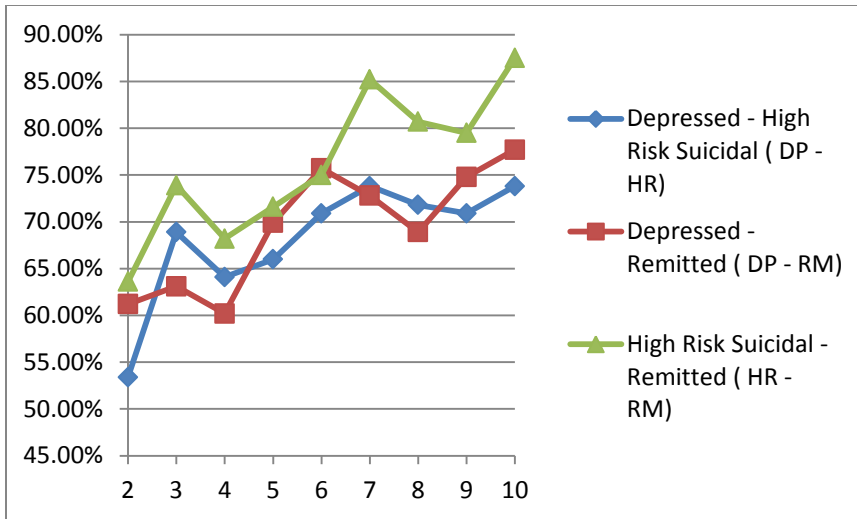

Figure 108: Female Reading Session with Quadratic Classification

All of the results about different pairwise groups' comparisons are shown in Table 44 below for the female reading session.

Table 44: Comparison of Pairwise Groups for the Female Patients Reading Session

FEMALE READING			
	Linear	Cross Validated	Quadratic
Band #	0 - 2000	0 - 2000	0 - 2000
2	DP - RM	DP - RM	HR - RM
3	HR - RM	HR - RM	HR - RM
4	HR - RM	HR - RM	HR - RM
5	HR - RM	HR - RM	HR - RM & DP - RM
6	DP - RM	DP - RM	HR - RM & DP - RM
7	HR - RM	HR - RM	HR - RM
8	HR - RM	HR - RM	HR - RM
9	HR - RM	HR - RM	HR - RM
10	HR - RM	HR - RM	HR - RM

3.1.5.2 Male Patients' Pairwise Group Comparisons

When the pairwise groups were compared for the male interview session with using the linear classification, DP-RM pairwise group gave the best classification rates for all bands except 2 bands, 3 bands, 9 bands and 10 bands. HR-RM pairwise group gave the best classification rates for 2 bands, 3 bands, 9 bands and 10 bands. These results can be seen in Figure 109 below.

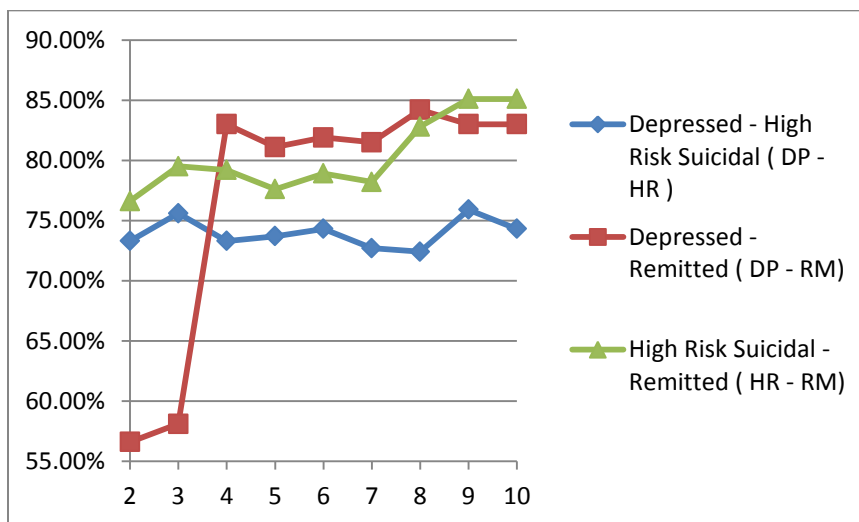

Figure 109: Male Interview Session with Linear Classification

When the pairwise groups were compared for the male interview session with using the cross validated classification, HR-RM pairwise group gave the best classification rates for all 2 bands, 3 bands, 9 bands and 10 bands. DP-RM pairwise group gave the best classification rate for 4 bands, 5 bands, 6 bands, 7 bands. Both the HR-RM pairwise

group and the DP-RM pairwise group gave good result for 8 bands. These results can be seen in Figure 110 below.

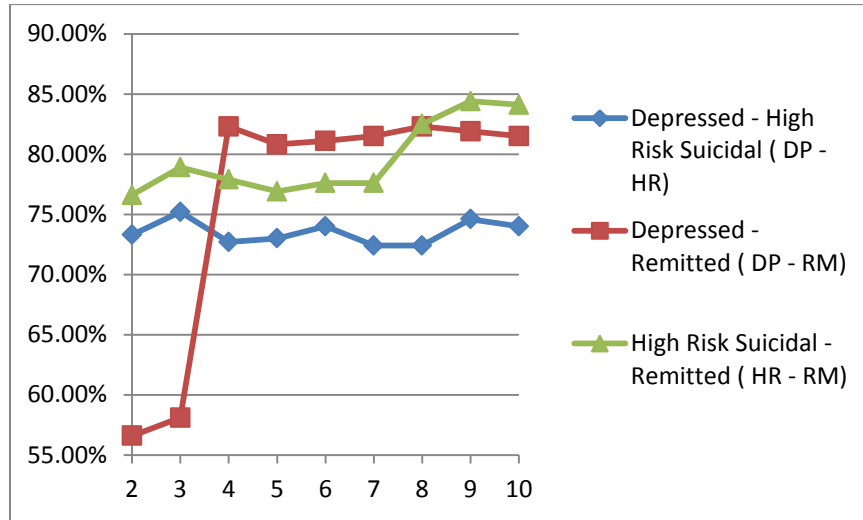

Figure 110: Male Interview Session with Cross Validated Classification

For the male interview session results with using the quadratic classification, HR-RM pairwise group gave the best classification rates for 2 bands, 3 bands, and 10 bands. DP-RM pairwise group gave the best classification rates for 4 bands, 5 bands, 6 bands, and 7 bands. Finally, both the HR-RM pairwise group and the DP-RM pairwise group gave good result for 8 bands and 9 bands and this can be seen in Figure 111.

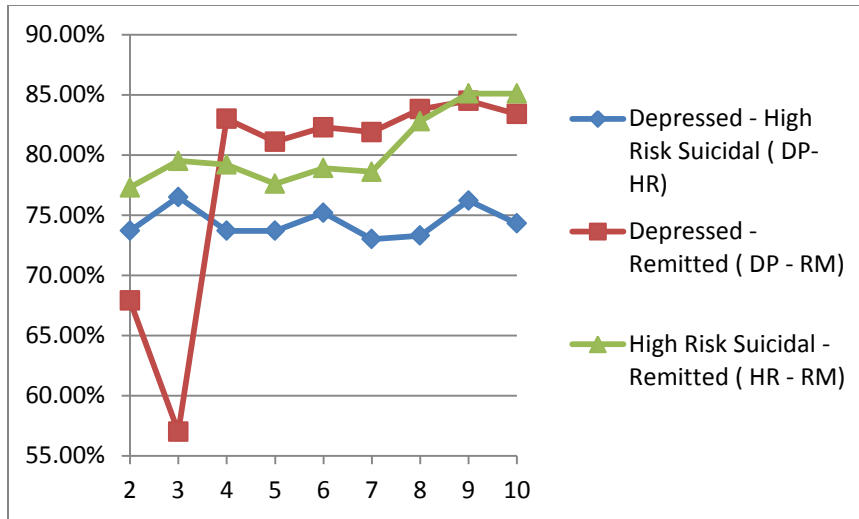

Figure 111: Male Interview Session with Quadratic Classification

All of the results about different pairwise groups' comparisons are shown in Table 45 below for the male interview session.

Table 45: Comparison of Pairwise Groups for the Male Patients Interview Session

MALE INTERVIEW			
	Linear	Cross Validated	Quadratic
Band #	0 - 2000	0 - 2000	0 - 2000
2	HR - RM	HR - RM	HR - RM
3	HR - RM	HR - RM	HR - RM
4	DP - RM	DP - RM	DP - RM
5	DP - RM	DP - RM	DP - RM
6	DP - RM	DP - RM	DP - RM
7	DP - RM	DP - RM	DP - RM
8	DP - RM	DP - RM & HR -RM	DP - RM & HR - RM
9	HR - RM	HR - RM	DP - RM & HR - RM
10	HR - RM	HR - RM	HR - RM

When the pairwise groups were compared for the male reading session with using the linear classification, HR-RM pairwise group gave the best classification rates for all bands. DP- HR pairwise group gave the best classification rates for 2 bands. DP-RM pairwise group gave the best classification rate for 4 bands and 8 bands. Finally, all pairwise groups gave the same best classification rate for 7 bands and 10 bands. These results can be seen in Figure 112 below.

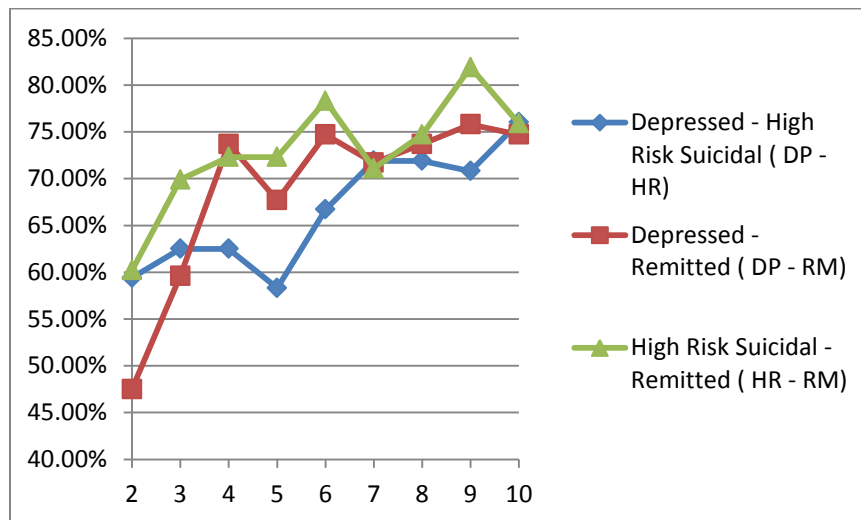

Figure 112: Male Reading Session with Linear Classification

When the pairwise groups were compared for the male reading session with using the cross validated classification, HR-RM pairwise group gave the best classification rates for all bands except 6 bands. DP- HR pairwise group gave the best classification rates for 2 bands. DP-RM pairwise group gave the best classification rate for 4 bands and 6 bands.

Finally, all pairwise groups gave the same best classification rate for 7 bands and 10 bands. These results can be seen in Figure 113 below.

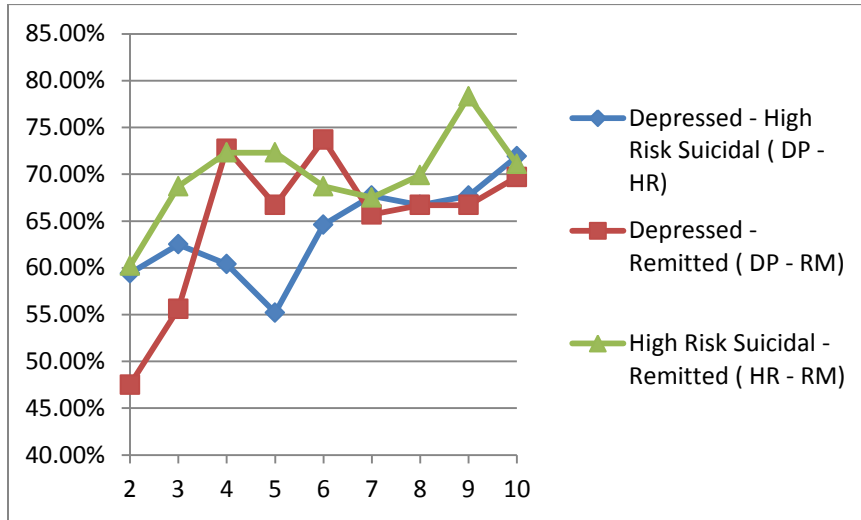

Figure 113: Male Reading Session with Cross Validated Classification

When the pairwise groups were compared for the male reading session with using the quadratic classification, HR-RM pairwise group gave the best classification rates for 2 bands, 3 bands, 6 bands, and 9 bands. DP-RM pairwise group gave the best classification rate for 4 bands, 5 bands and 6 bands. DP- HR pairwise group gave the best classification rates for 7 bands and 10 bands. Finally, all pairwise groups gave the best classification rate for 8 bands. These results can be seen in Figure 114 below.

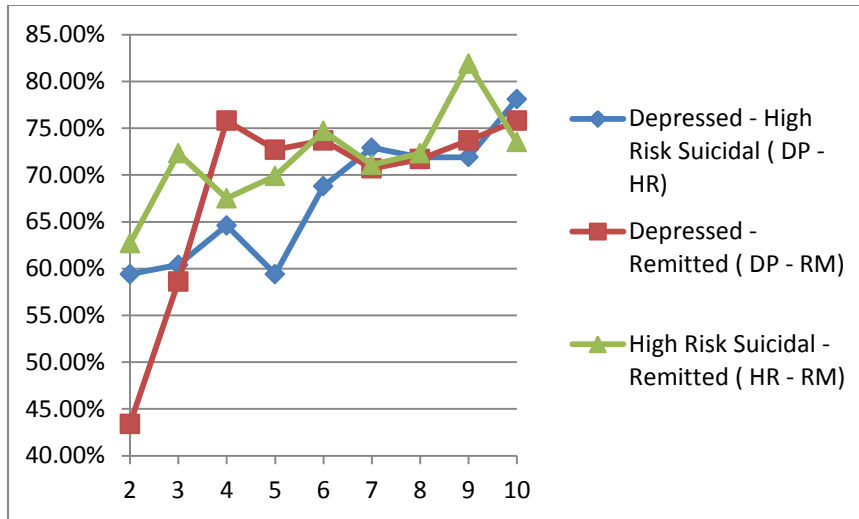

Figure 114: Male Reading Session with Quadratic Classification

All of the results about different pairwise groups' comparisons are shown in Table 46 below for the male reading session.

Table 46: Comparison of Pairwise Groups for the Male Patients Reading Session

MALE READING			
	Linear	Cross Validated	Quadratic
Band #	0 - 2000	0 - 2000	0 - 2000
2	HR - RM & DP - HR	HR - RM & DP - HR	HR - RM
3	HR - RM	HR - RM	HR - RM
4	HR - RM & DP - RM	HR - RM & DP - RM	DP - RM
5	HR - RM	HR - RM	DP - RM
6	HR - RM	DP - RM	HR - RM & DP - RM
7	All Same	All Same	DP - HR
8	HR - RM & DP - RM	HR - RM	All same
9	HR - RM	HR - RM	HR - RM
10	All Same	All Same	DP - HR

3.2 Optimization with Different Energy Band Ranges

In the previous section, different numbers of energy bands in the 0 – 2000 Hz frequency range have been studied and their effects on classification have been analyzed. For this part of the research, the optimization with different band ranges has been analyzed. The analyzed energy band ranges are 0-2000 Hz and 0-3000 Hz frequency range. Different numbers of energy bands has been studied in the 0 – 3000 Hz frequency range and the difference between 0-2000 Hz and 0-3000 Hz frequency range had been analyzed in this section.

Different numbers of energy bands were studied in the 0 – 3000 Hz frequency range. Two equal bands (0-1500 Hz, 1500-3000 Hz), three equal bands (0-1000 Hz, 1000-2000 Hz, 2000-3000 Hz), four equal bands (0-750 Hz, 750-1500 Hz, 1500-2250 Hz, 2250-3000 Hz), five equal bands (0-600 Hz, 600-1200 Hz, 1200-1800 Hz, 1800-2400 Hz, 2400- 3000 Hz), six equal bands (0-500 Hz, 500-1000 Hz, 1000-1500 Hz, 1500-2000 Hz, 2000-2500 Hz, 2500-3000 Hz), seven equal bands (0-428 Hz, 428-857 Hz, 857-1286 Hz, 1286-1714 Hz, 1714-2142 Hz, 2142-2571 Hz, 2571-3000 Hz), eight equal bands (0-375 Hz, 375-750 Hz, 750-1125 Hz, 1125-1500 Hz, 1500-1875 Hz, 1875-2250 Hz, 2250-2625 Hz, 2625-3000 Hz), nine equal bands (0-333 Hz, 333-667 Hz, 667-1000 Hz, 1000-1333 Hz, 1333-1666 Hz, 1666-1999 Hz, 1999-2332 Hz, 2332-2666 Hz, 2666-3000 Hz) and ten equal bands (0-300 Hz, 300-600 Hz, 600-900 Hz, 900-1200 Hz, 1200-1500 Hz, 1500-1800 Hz, 1800-2100 Hz, 2100-2400 Hz, 2400- 2700 Hz, 2700-3000 Hz) were analyzed.

Pairwise discriminant analyses were examined by three different discriminant classifiers; linear discriminant analysis, quadratic discriminant analysis, and cross validated (the leave-one-out classification method) discriminant analysis were used to classify high risk suicidal patients from the depressed patients and the remitted patients.

Three different pairwise groups were investigated for the discriminant analyses. They are Depressed – High Risk Suicidal (DP-HR) pairwise group, Depressed – Remitted (DP-RM) pairwise group, and High Risk Suicidal – Remitted (HR-RM) pairwise group. Two different types of recordings (interview session, reading session) were analyzed for both the female and the male patients. They are speech recordings during the interview session and during the reading session.

3.2.1 Different Band Ranges Results for the Female Patients

3.2.1.1 Depressed & High Risk Suicidal (DP – HR) Pairwise Group

3.2.1.1.1 Linear Classification Results

Depressed – High Risk Suicidal (DP-HR) pairwise group for the female patients using the linear classifier were studied with different band numbers and different band ranges of 0-2000 Hz and 0-3000 Hz. According to the linear classification, the discrimination results are better with 0-2000 Hz frequency range for the interview session except 2 bands, 3 bands, and 4 bands. For 2 bands, 3 bands, and 4 bands both ranges gave similar results; for the other bands 0-2000 Hz frequency range gave better results. Figure 115 below shows the classification results for different band numbers for the female DP-HR interview session having different band ranges (0-2000 Hz and 0-3000 Hz).

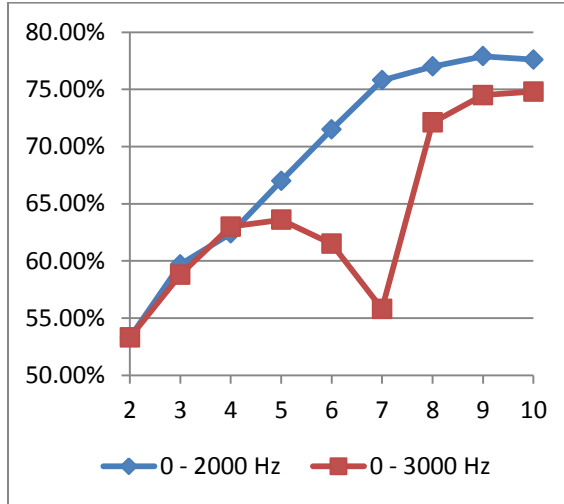

Figure 115: Female DP – HR Interview Session

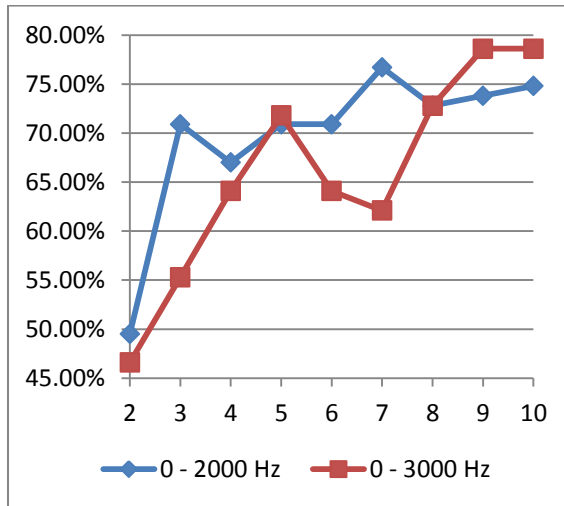

Figure 116: Female DP – HR Reading Session

For the reading session of the Depressed – High Risk Suicidal (DP-HR) pairwise group for the female patients using the linear classification; the classification rate of 0-2000 Hz frequency range is higher for all bands except 5 bands, 8 bands, 9 and 10 bands.

The classification rate of 0-3000 Hz frequency range is higher for 9 bands and 10 bands. They gave the same classification rate for 5 bands, 8 bands. Figure 116 above shows these results.

3.2.1.1.2 Cross Validated Classification Results

Depressed – High Risk Suicidal (DP-HR) pairwise group for the female patients using the cross validated classifier were studied with different band numbers and different band ranges of 0-2000 Hz and 0-3000 Hz. The discrimination results are better with 0-2000 Hz frequency range for the interview session except 2 bands and 4 bands. For 2 bands and 4 bands, both ranges gave similar results; for the other bands, the 0-2000 Hz frequency range gave better results. Figure 117 below shows the classification results for different band numbers for the female DP-HR interview session having different band ranges.

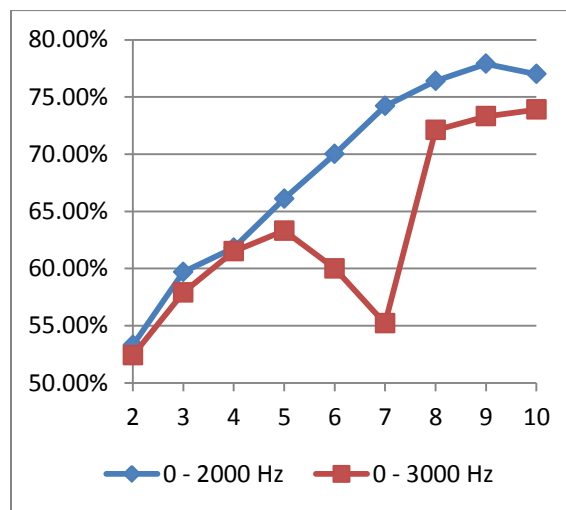

Figure 117: Female DP – HR Interview Session

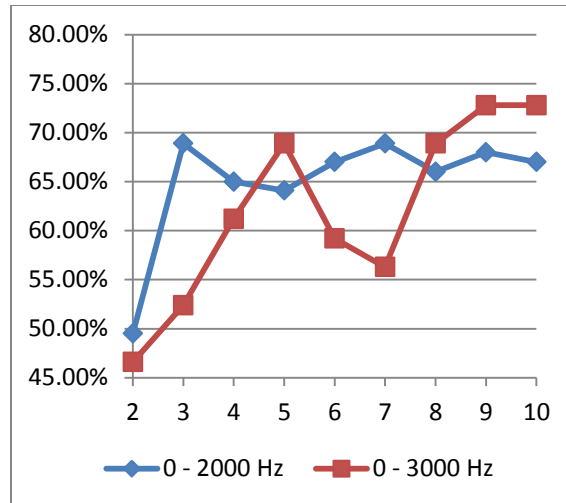

Figure 118: Female DP – HR Reading Session

For the reading session of the Depressed – High Risk Suicidal (DP-HR) pairwise group for the female patients using the cross validated classification; the classification rate of 0-2000 Hz frequency range is higher for all bands except 5 bands, 8 bands, 9 bands and 10 bands. The classification rate of 0-3000 Hz frequency range is higher for 5 bands, 8 bands, 9 bands and 10 bands. Figure 118 above shows these results.

3.2.1.1.3 Quadratic Classification Results

Depressed – High Risk Suicidal (DP-HR) pairwise group for the female patients using the quadratic classifier were studied with different band numbers and different band ranges of 0-2000 Hz and 0-3000 Hz. According to the quadratic classification, the discrimination results of the interview session are better with 0-2000 Hz frequency range for all bands. Figure 119 below shows these results.

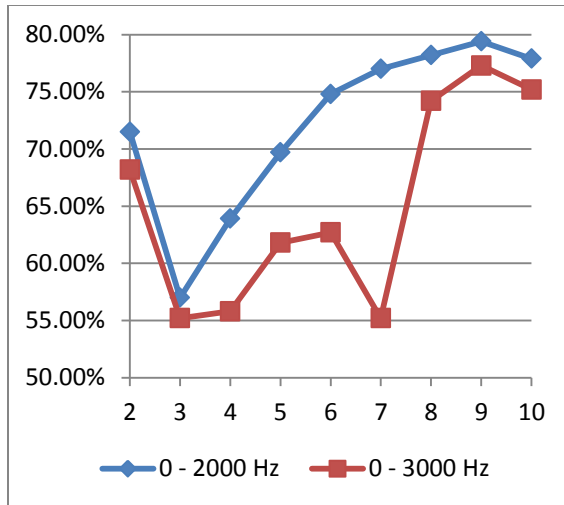

Figure 119: Female DP – HR Interview Session

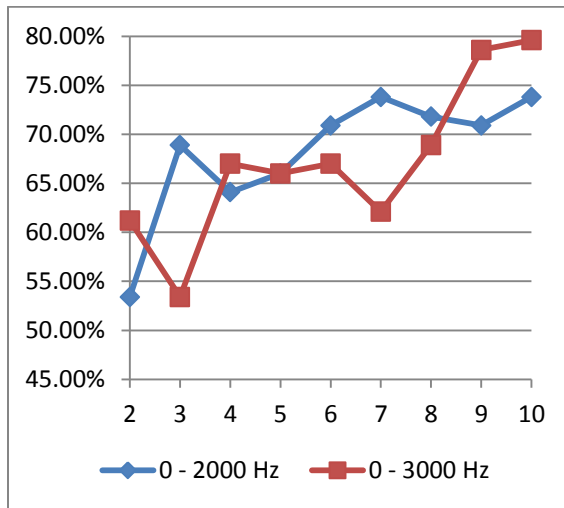

Figure 120: Female DP – HR Reading Session

For the reading session of the Depressed – High Risk Suicidal (DP-HR) pairwise group for the female patients using the quadratic classification; the classification rate of 0-2000 Hz frequency range is higher for all bands except 2 bands, 4 bands, 5 bands, 9 bands and 10 bands. The classification rate of 0-3000 Hz frequency range is higher for 2 bands, 4

bands, 9 bands and 10 bands. For 5 bands, both ranges gave the same result. Figure 120 above shows the classification results for different band numbers for the female DP-HR reading session having different band ranges (0-2000 Hz and 0-3000 Hz) using the quadratic classification.

3.2.1.2 Depressed & Remitted (DP – RM) Pairwise Group

3.2.1.2.1 Linear Classification Results

Depressed – Remitted (DP-RM) pairwise group for the female patients using the linear classifier were studied with different band numbers and different band ranges of 0-2000 Hz and 0-3000 Hz. The discrimination results are better with 0-3000 Hz frequency range for the interview session except 2 bands, 9 bands and 10 bands. For 2 bands, both ranges gave similar results. Figure 121 below shows the classification results for different band numbers for the female DP-RM interview session having different band ranges.

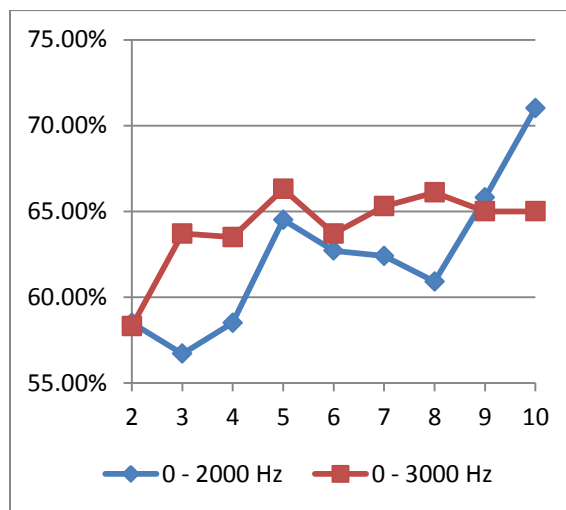

Figure 121: Female DP – RM Interview Session

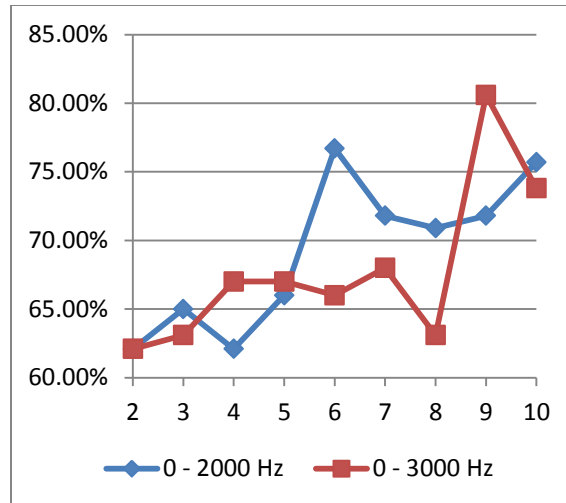

Figure 122: Female DP – RM Reading Session

For the reading session of the Depressed – Remitted (DP-RM) pairwise group for the female patients using the linear classification; the classification rate of 0-2000 Hz frequency range is higher for all bands except 2 bands, 4 bands, 5 bands, and 9 bands. The classification rate of 0-3000 Hz frequency range is higher for 4 bands, 5 bands and 9 bands. They gave the same classification rate for 2 bands. Figure 122 above shows these results.

3.2.1.2.2 Cross Validated Classification Results

The discrimination results are better with 0-3000 Hz frequency range except 2 bands, 9 bands, and 10 bands for the interview session of Depressed – Remitted (DP-RM) pairwise group for the female patients using the cross validated classifier. For 2 bands and 9 bands, both ranges gave the same results. Figure 123 below shows the classification

results for different band numbers for the female DP-RM interview session having different band ranges.

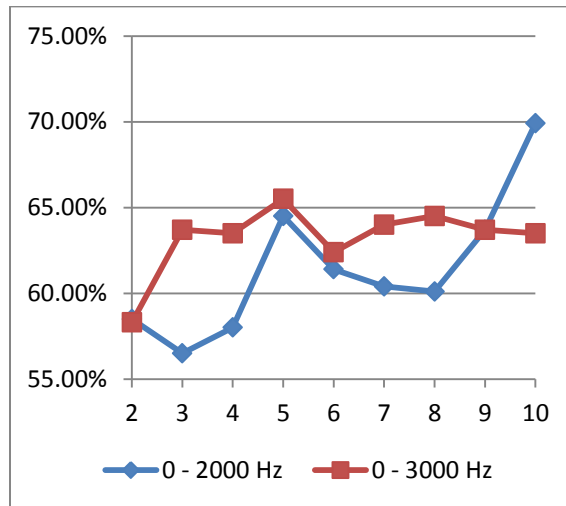

Figure 123: Female DP – RM Interview Session

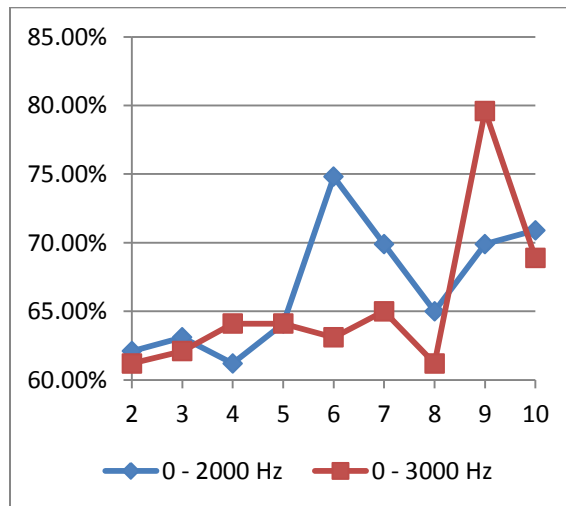

Figure 124: Female DP – RM Reading Session

For the reading session of the Depressed – Remitted (DP-RM) pairwise group for the female patients using the cross validated classification; the classification rate of 0-2000 Hz frequency range is higher for all bands except 4 bands, 5 bands and 9 bands. The classification rate of 0-3000 Hz frequency range is higher for 4 bands and 9 bands. They are the same for 5 bands. Figure 124 above shows these results.

3.2.1.2.3 Quadratic Classification Results

Depressed – Remitted (DP-RM) pairwise group for the female patients using the quadratic classifier were studied with different band numbers and different band ranges of 0-2000 Hz and 0-3000 Hz. According to the quadratic classification, the discrimination results of the interview session are better with 0-2000 Hz frequency range for all bands except 3 bands. For 3 bands, the discrimination results of the interview session are better with 0-3000 Hz frequency range Figure 125 below shows these results.

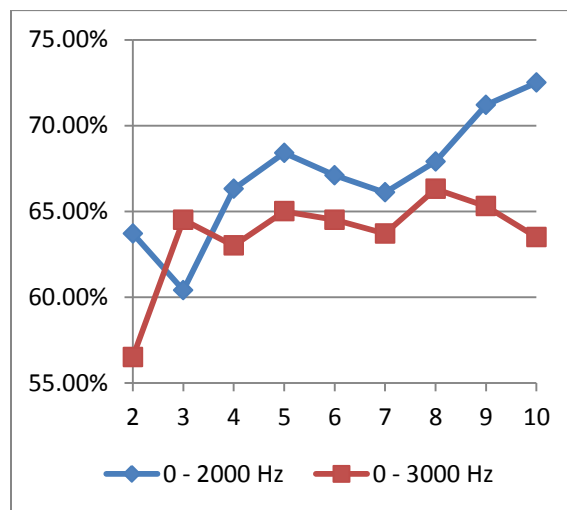

Figure 125: Female DP – RM Interview Session

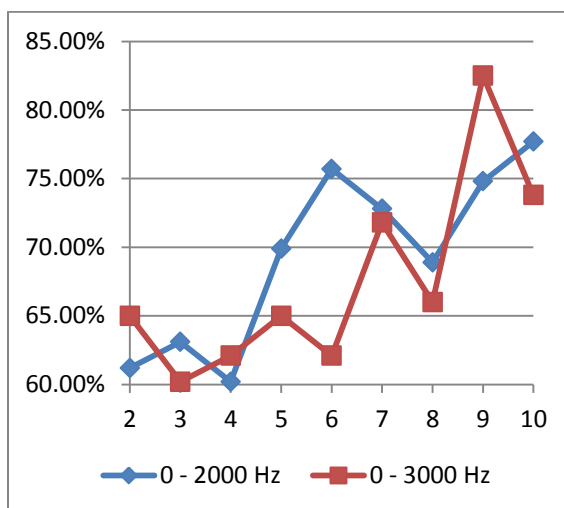

Figure 126: Female DP – RM Reading Session

For the reading session of the Depressed – Remitted (DP-RM) pairwise group for the female patients using the quadratic classification; the classification rate of 0-2000 Hz frequency range is higher for all bands except 2 bands, 4 bands, and 9 bands. The classification rate of 0-3000 Hz frequency range is higher for 2 bands, 4 bands, and 9 bands. Figure 126 above shows the classification results for different band numbers.

3.2.1.3 High Risk Suicidal & Remitted (HR – RM) Pairwise Group

3.2.1.3.1 Linear Classification Results

High Risk Suicidal – Remitted (HR-RM) pairwise group for the female patients using the linear classifier were studied with different band numbers and different band ranges of 0-2000 Hz and 0-3000 Hz. According to the linear classification, the classification rate of 0-2000 Hz frequency range is higher for all bands except 2 bands, 5 bands, and 8 bands for the interview session. For 2 bands, 5 bands, and 8 bands, 0-3000

Hz frequency range gave better results. Figure 127 below shows the classification results for different band numbers for the female HR-RM interview session having different band ranges (0-2000 Hz and 0-3000 Hz).

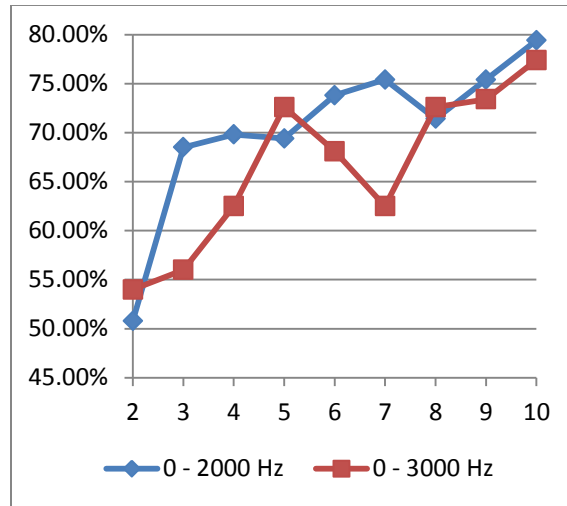

Figure 127: Female HR – RM Interview Session

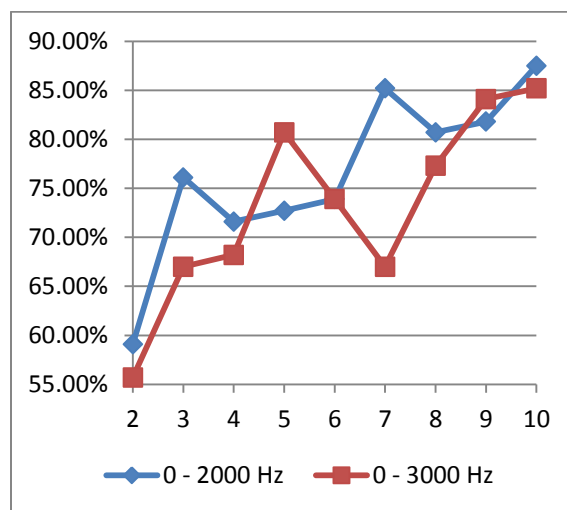

Figure 128: Female HR – RM Reading Session

For the reading session of the High Risk Suicidal – Remitted (HR-RM) pairwise group for the female patients using the linear classification; the classification rate of 0-2000 Hz frequency range is higher for all bands except 5 bands, 6 bands, and 9 bands. The classification rate of 0-3000 Hz frequency range is higher for 5 bands and 9 bands. They gave the same classification rate for 5 bands. Figure 128 above shows these results.

3.2.1.3.2 Cross Validated Classification Results

High Risk Suicidal – Remitted (HR-RM) pairwise group for the female patients using the cross validated classifier were studied with different band numbers and different band ranges of 0-2000 Hz and 0-3000 Hz. The discrimination results are better with 0-2000 Hz frequency range for the interview session except 2 bands, 5 bands, and 8 bands. For 2 bands, 5 bands and 8 bands, 0-3000 Hz frequency range gave better discrimination results. Figure 129 below shows the classification results for different band numbers for the female HR-RM interview session having different band ranges.

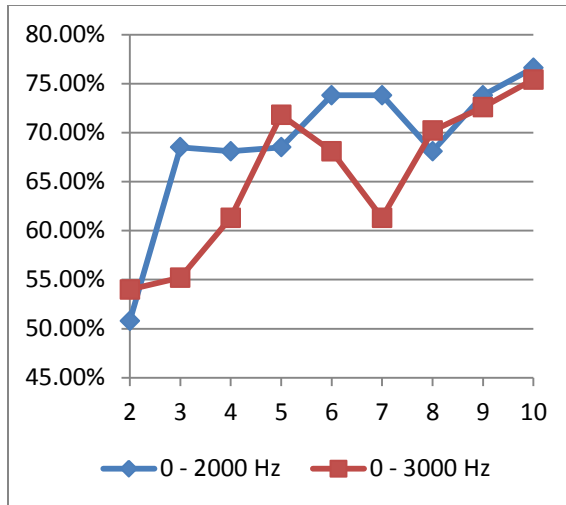

Figure 129: Female HR – RM Interview Session

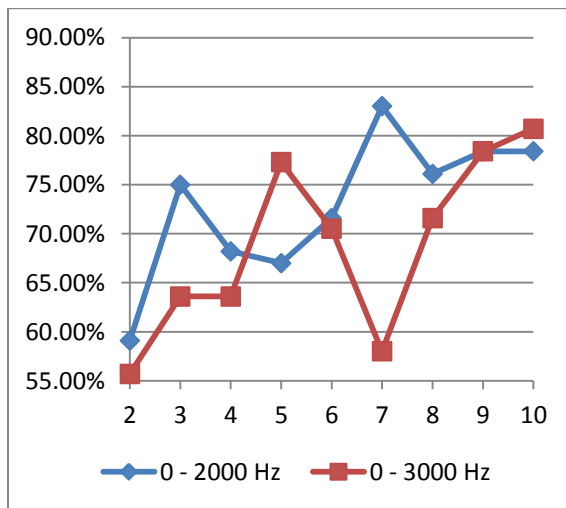

Figure 130: Female HR – RM Reading Session

For the reading session of the High Risk Suicidal – Remitted (HR-RM) pairwise group for the female patients using the cross validated classification; the classification rate of 0-2000 Hz frequency range is higher for all bands except 5 bands, 9 bands and 10 bands.

The classification rate of 0-3000 Hz frequency range is higher for 5 bands, 10 bands but both ranges are equal for 9 bands. Figure 130 above shows these results.

3.2.1.3.3 Quadratic Classification Results

High Risk Suicidal – Remitted (HR-RM) pairwise group for the female patients using the quadratic classifier were studied with different band numbers and different band ranges of 0-2000 Hz and 0-3000 Hz. According to the quadratic classification, the discrimination results of the interview session are better with 0-2000 Hz frequency range for all bands except 5 bands, 8 bands, and 9 bands. Both frequency ranges gave the same classification rate for 8 bands and 9 bands. For 5 bands, the discrimination results are better with 0-3000 Hz frequency range. Figure 131 below shows these results.

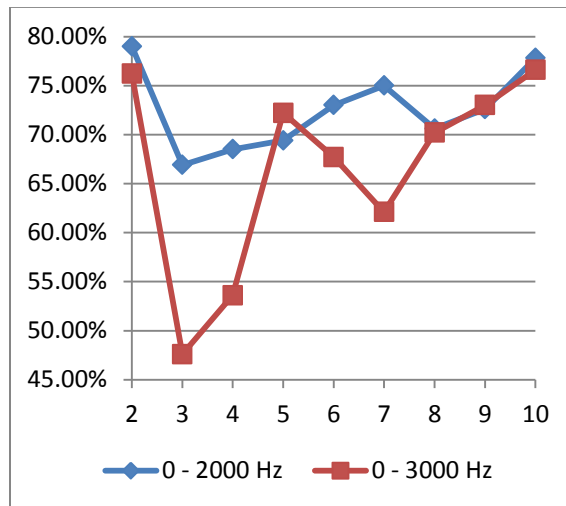

Figure 131: Female HR – RM Interview Session

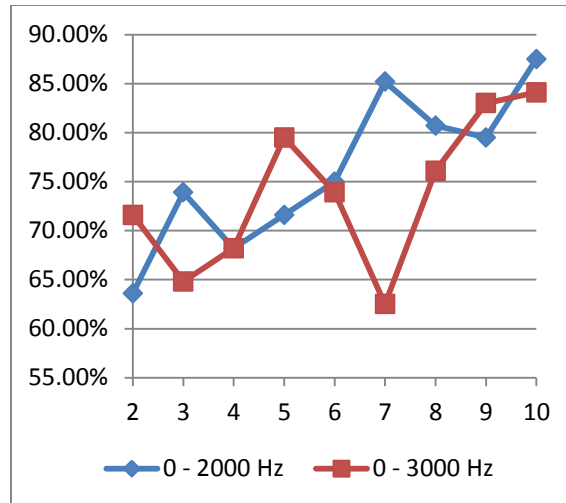

Figure 132: Female HR – RM Reading Session

For the reading session of the High Risk Suicidal – Remitted (HR-RM) pairwise group for the female patients using the quadratic classification; the classification rate of 0-2000 Hz frequency range is higher for 3 bands, 7 bands, 8 bands and 10 bands. The classification rate of 0-3000 Hz frequency range is higher for 2 bands, 5 bands, and 9 bands. For 4 bands and 6 bands, both ranges gave about the same result. Figure 132 above shows the classification results for different band numbers for the female HR-RM reading session having different band ranges using the quadratic classification.

The table below, Table 47, shows all the best results that had been found for different pairwise groups with different classification methods and with different band frequency ranges for the female patients.

Table 47: The Best Band Number Results for the Female Patients with Different Band Frequency Ranges

FEMALE PATIENTS (0 – 2000 Hz)						
Pairwise Group	Optimized Band Numbers			Classification Rate		
	Linear	Cross Validated	Quadratic	Linear	Cross Validated	Quadratic
DP – HR Interview	9 bands	9 bands	9 bands	77.90%	77.90%	79.40%
DP – HR Reading	7 bands	7 bands & 3 bands	7 bands & 10 bands	76.70%	68.90%	73.80%
DP – RM Interview	10 bands	10 bands	10 bands	71.00%	69.90%	72.50%
DP – RM Reading	6 bands	6 bands	10 bands	76.70%	74.80%	77.70%
HR – RM Interview	10 bands	10 bands	2 bands	79.40%	76.60%	79.00%
HR – RM Reading	10 bands	7 bands	10 bands	87.50%	83.00%	87.50%
FEMALE PATIENTS (0 – 3000 Hz)						
Pairwise Group	Optimized Band Numbers			Classification Rate		
	Linear	Cross Validated	Quadratic	Linear	Cross Validated	Quadratic
DP – HR Interview	10 bands	10 bands	9 bands	74.80%	73.90%	77.30%
DP – HR Reading	9 bands & 10 bands	9 bands & 10 bands	10 bands	78.60%	72.80%	79.60%
DP – RM Interview	5 bands	5 bands	8 bands	66.30%	65.50%	66.30%
DP – RM Reading	9 bands	9 bands	9 bands	80.60%	79.60%	82.50%
HR – RM Interview	10 bands	10 bands	10 bands	77.40%	75.40%	76.60%
HR – RM Reading	10 bands	10 bands	10 bands	85.20%	80.70%	84.10%

3.2.2 Different Band Ranges Results for the Male Patients

3.2.2.1 Depressed & High Risk Suicidal (DP – HR) Pairwise Group

3.2.2.1.1 Linear Classification Results

Depressed – High Risk Suicidal (DP-HR) pairwise group for the male patients using the linear classifier were studied with different band numbers and different band ranges of 0-2000 Hz and 0-3000 Hz. According to the linear classification, the discrimination results are better with 0-3000 Hz frequency range for the interview session for all bands. Figure 133 below shows the classification results for different band numbers for the male DP-HR interview session having different band ranges.

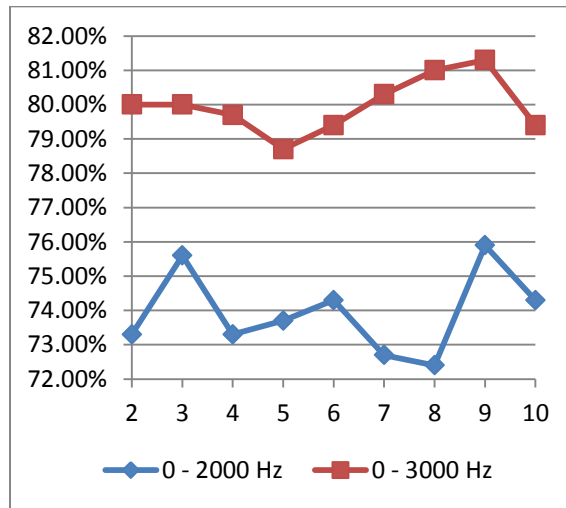

Figure 133: Male DP – HR Interview Session

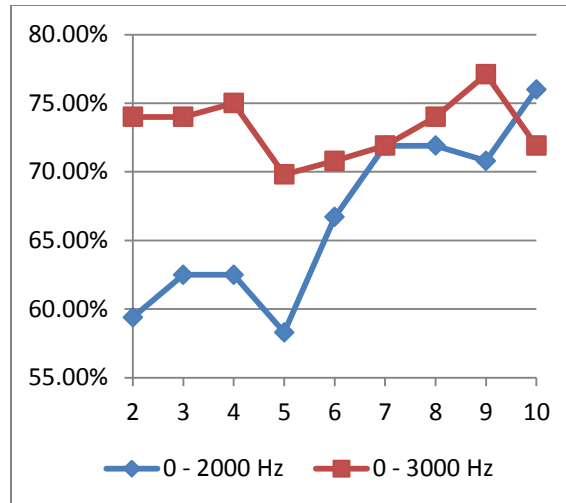

Figure 134: Male DP – HR Reading Session

For the reading session of the Depressed – High Risk Suicidal (DP-HR) pairwise group for the male patients using the linear classification; the classification rate of 0-3000 Hz frequency range is higher for all bands except 7 bands, and 10 bands. The classification rate of 0-2000 Hz frequency range is higher for only 10 bands, and they gave the same classification rate for 7 bands. Figure 134 above shows these results.

3.2.2.1.2 Cross Validated Classification Results

Depressed – High Risk Suicidal (DP-HR) pairwise group for the male patients using the cross validated classifier were studied with different band numbers and different band ranges of 0-2000 Hz and 0-3000 Hz. The discrimination results are better with 0-3000 Hz frequency range for the interview session. This result can be seen in Figure 135 below.

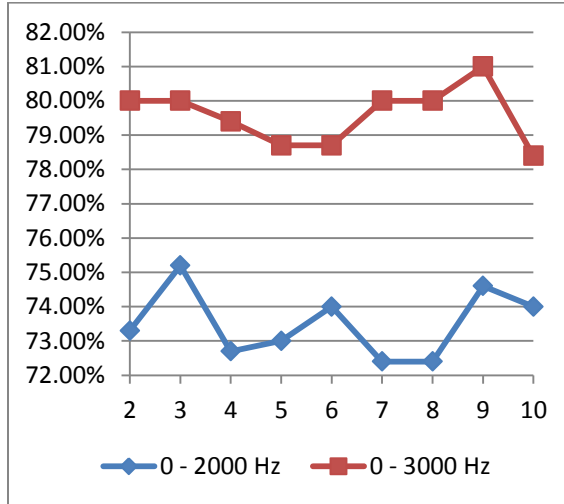

Figure 135: Male DP – HR Interview Session

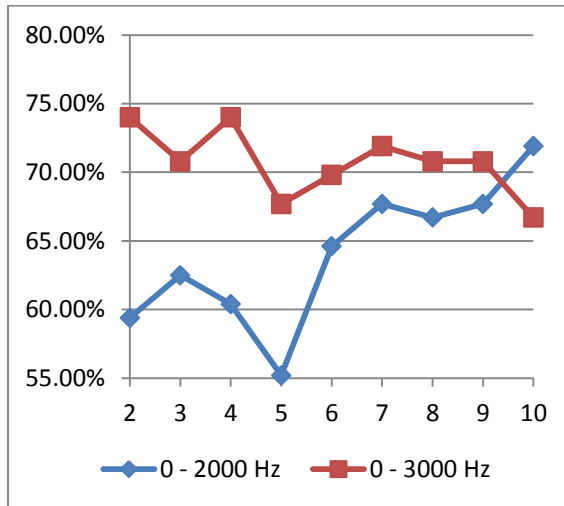

Figure 136: Male DP – HR Reading Session

For the reading session of the Depressed – High Risk Suicidal (DP-HR) pairwise group for male patients using the cross validated classification; the classification rate of 0-3000

Hz frequency range is higher for all bands except 10 bands. The classification rate of 0-2000 Hz frequency range is higher for 10 bands. Figure 136 above shows these results.

3.2.2.1.3 Quadratic Classification Results

Depressed – High Risk Suicidal (DP-HR) pairwise group for the male patients using the quadratic classifier were studied with different band numbers and different band ranges of 0-2000 Hz and 0-3000 Hz. According to the quadratic classification, the discrimination results of the interview session are better with 0-3000 Hz frequency range for all bands. Figure 137 below shows these results.

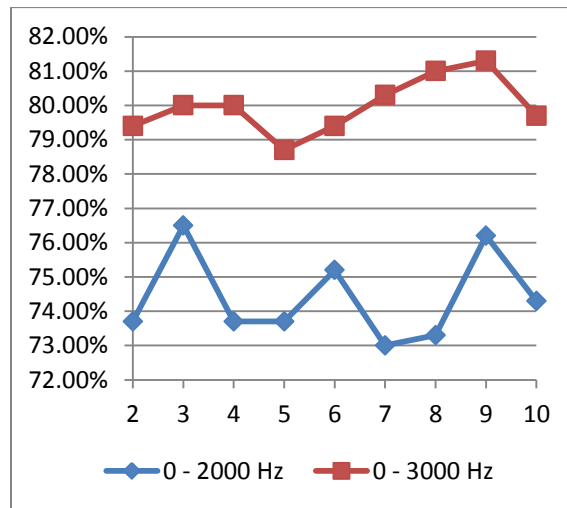

Figure 137: Male DP – HR Interview Session

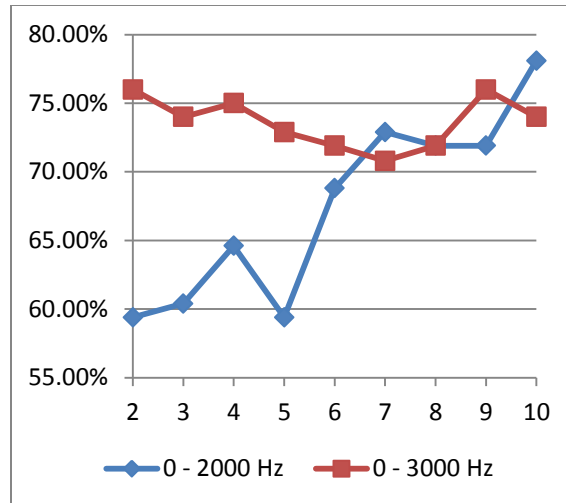

Figure 138: Male DP – HR Reading Session

For the reading session of the Depressed – High Risk Suicidal (DP-HR) pairwise group for the male patients using the quadratic classification; the classification rate of 0-3000 Hz frequency range is higher for all bands except 7 bands, 8 bands, and 10 bands. The classification rate of 0-2000 Hz frequency range is higher for 7 bands, 10 bands. For 8 bands, both ranges gave the same result. Figure 138 above shows the classification results for different band numbers for the male DP-HR reading session having different band ranges (0-2000 Hz and 0-3000 Hz) using the quadratic classification.

3.2.2.2 Depressed & Remitted (DP – RM) Pairwise Group

3.2.2.2.1 Linear Classification Results

Depressed – Remitted (DP-RM) pairwise group for the male patients using the linear classifier were studied with different band numbers and different band ranges of 0-2000 Hz and 0-3000 Hz. The discrimination results are better with 0-2000 Hz frequency

range for the interview session except 3 bands, 9 bands and 10 bands. For 9 bands and 10 bands, both ranges gave the same results. For 3 bands, the discrimination results are better with 0-2000 Hz frequency range. Figure 139 below shows the classification results for different band numbers for the male DP-RM interview session having different band ranges.

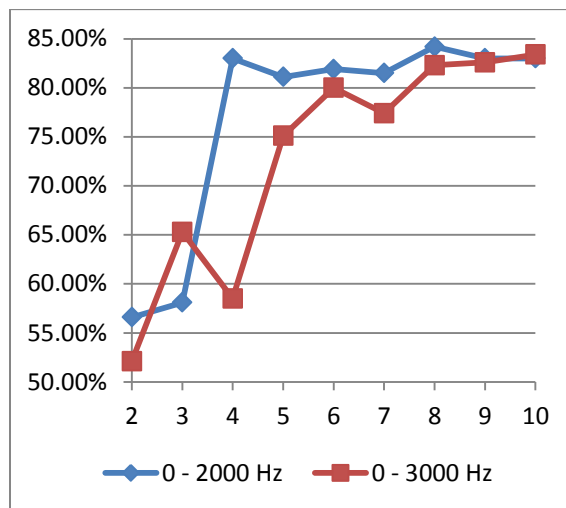

Figure 139: Male DP – RM Interview Session

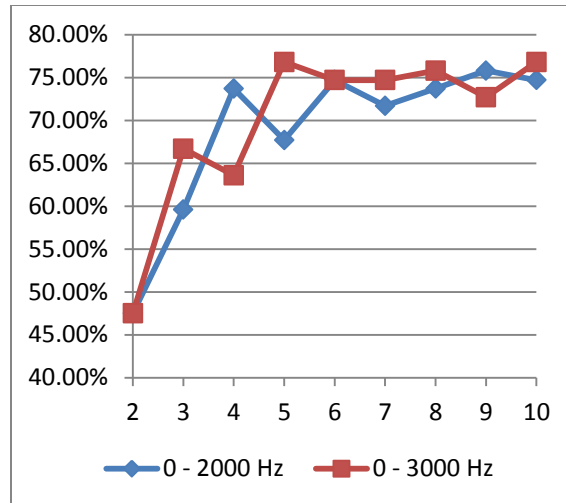

Figure 140: Male DP – RM Reading Session

For the reading session of the Depressed – Remitted (DP-RM) pairwise group for the male patients using the linear classification; the classification rate of 0-3000 Hz frequency range is higher for all bands except 2 bands, 4 bands, 6 bands, and 9 bands. The classification rate of 0-2000 Hz frequency range is higher for 4 bands, and 9 bands. They gave the same classification rate for 2 bands and 6 bands. Figure 140 above shows these results.

3.2.2.2.2 Cross Validated Classification Results

The discrimination results are better with 0-2000 Hz frequency range except 3 bands, 9 bands, and 10 bands for the interview session of Depressed – Remitted (DP-RM) pairwise group for the male patients using the cross validated classifier. For 9 bands and 10 bands, both ranges gave the same results. The discrimination results are better with 0-3000 Hz frequency range for 3 bands. Figure 141 below shows the classification results

for different band numbers for the male DP-RM interview session having different band ranges.

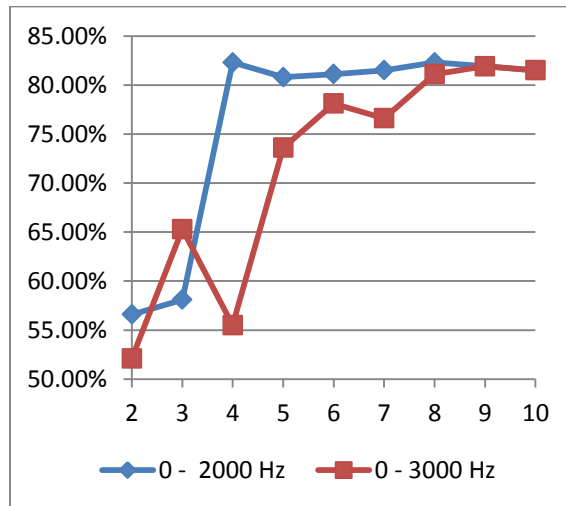

Figure 141: Male DP – RM Interview Session

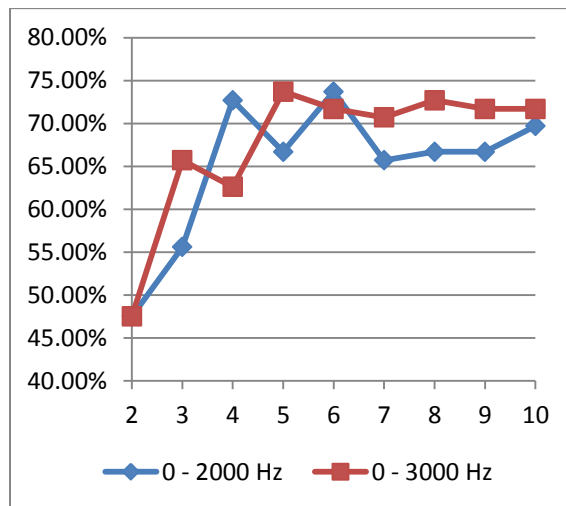

Figure 142: Male DP – RM Reading Session

For the reading session of the Depressed – Remitted (DP-RM) pairwise group for the male patients using the cross validated classification; the classification rate of 0-3000 Hz frequency range is higher for all bands except 2 bands, 4 bands, and 6 bands. The classification rate of 0-2000 Hz frequency range is higher for 4 bands and 6 bands. They are the same for 2 bands. Figure 142 above shows these results.

3.2.2.2.3 Quadratic Classification Results

Depressed – Remitted (DP-RM) pairwise group for the male patients using the quadratic classifier were studied with different band numbers and different band ranges of 0-2000 Hz and 0-3000 Hz. According to the quadratic classification, the discrimination results of the interview session are better with 0-3000 Hz frequency range for all bands except 4 bands, 6 bands, 9 bands and 10 bands. For 4 bands and 9 bands, the discrimination results of the interview session are better with 0-2000 Hz frequency range. The discrimination results of 0-2000 Hz frequency range and 0-3000 Hz frequency range are the same for 6 bands and 10 bands. Figure 143 shows these results.

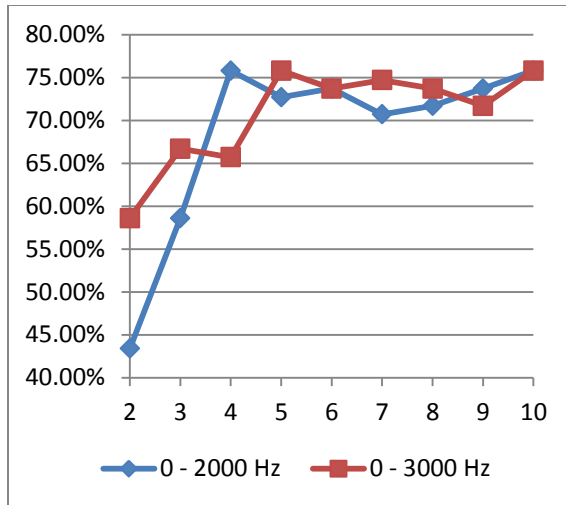

Figure 143: Male DP – RM Interview Session

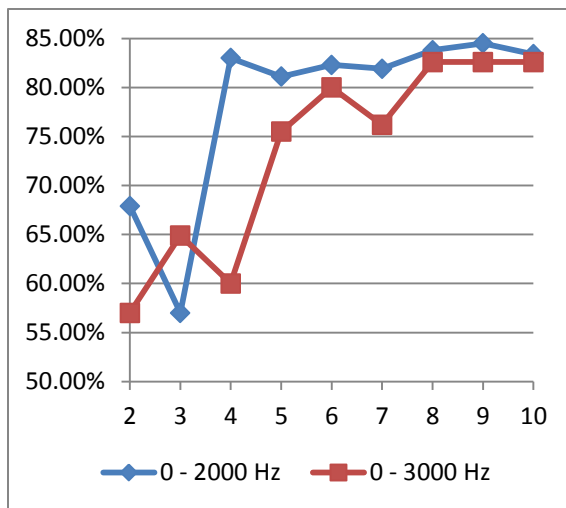

Figure 144: Male DP – RM Reading Session

For the reading session of the Depressed – Remitted (DP-RM) pairwise group for the male patients using the quadratic classification; the classification rate of 0-2000 Hz frequency range is higher for all bands except 3 bands. The classification rate of 0-3000

Hz frequency range is higher for 3 bands. Figure 144 above shows the classification results for different band numbers.

3.2.2.3 High Risk Suicidal & Remitted (HR – RM) Pairwise Group

3.2.2.3.1 Linear Classification Results

For the male patients, High Risk Suicidal – Remitted (HR-RM) pairwise group using the linear classifier were studied with different band numbers and different band ranges of 0-2000 Hz and 0-3000 Hz. According to the linear classification, the classification rate of 0-3000 Hz frequency range is higher for all bands except 9 bands for the interview session. For 9 bands, both frequency ranges gave similar results. Figure 145 below shows the classification results for different band numbers for the female HR-RM interview session having different band ranges (0-2000 Hz and 0-3000 Hz).

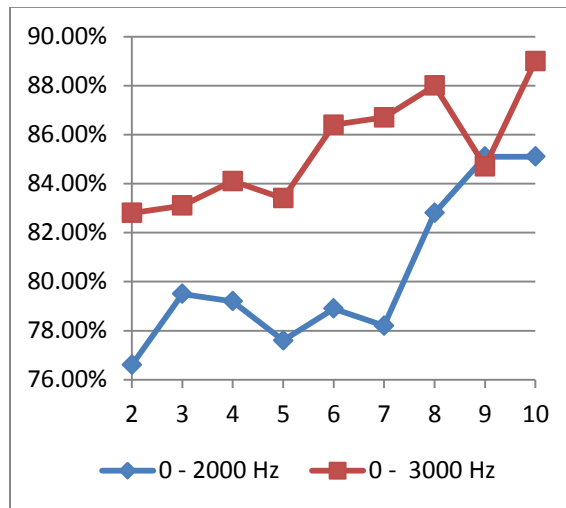

Figure 145: Male HR – RM Interview Session

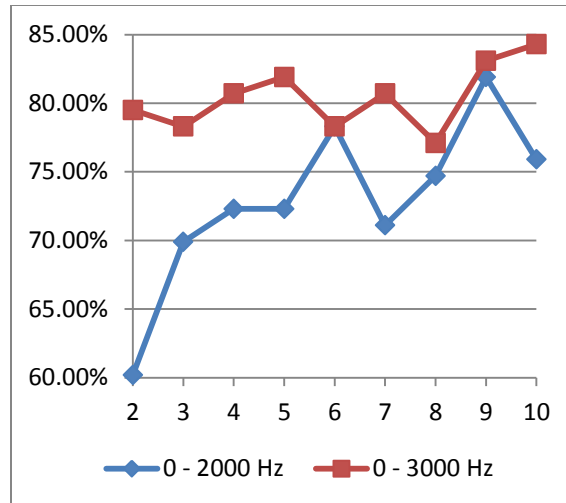

Figure 146: Male HR – RM Reading Session

For the reading session of the High Risk Suicidal – Remitted (HR-RM) pairwise group for the male patients using the linear classification; the classification rate of 0-3000 Hz frequency range is higher for all bands except 6 bands. They gave the same classification rate for 6 bands. Figure 146 above shows these results.

3.2.2.3.2 Cross Validated Classification Results

High Risk Suicidal – Remitted (HR-RM) pairwise group for the male patients using the cross validated classifier were studied with different band numbers and different band ranges of 0-2000 Hz and 0-3000 Hz. The discrimination results are better with 0-3000 Hz frequency range for the interview session except 9 bands. Both the 0-2000 Hz and the 0-3000 Hz frequency ranges gave the same good discrimination results for 9 bands. Figure 147 below shows the classification results for different band numbers for the male HR-RM interview session having different band ranges.

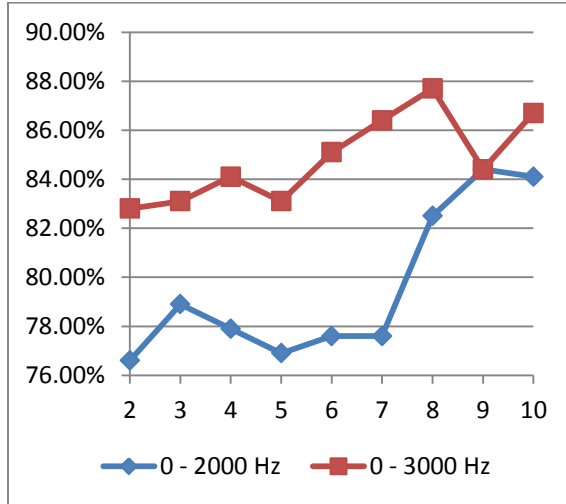

Figure 147: Male HR – RM Interview Session

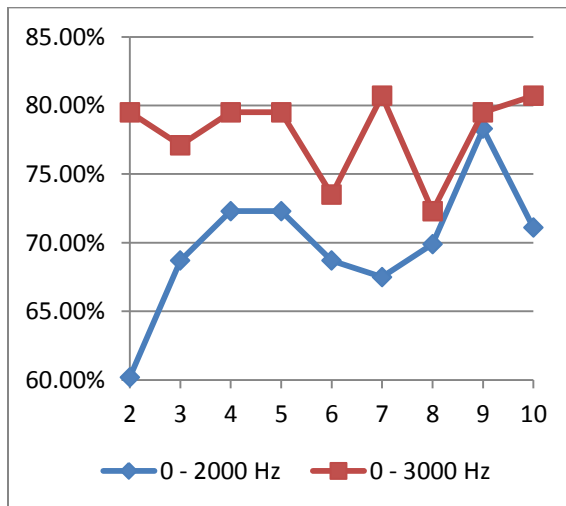

Figure 148: Male HR – RM Reading Session

For the reading session of the High Risk Suicidal – Remitted (HR-RM) pairwise group for the male patients using the cross validated classification; the classification rate of 0-3000 Hz frequency range is higher for all bands. Figure 148 above shows these results.

3.2.2.3.3 Quadratic Classification Results

High Risk Suicidal – Remitted (HR-RM) pairwise group for the male patients using the quadratic classifier were studied with different band numbers and different band ranges of 0-2000 Hz and 0-3000 Hz. According to the quadratic classification, the discrimination results of the interview session are better with 0-3000 Hz frequency range for all bands except 9 bands. Both frequency ranges gave the same classification rate for 9 bands. Figure 149 below shows these results.

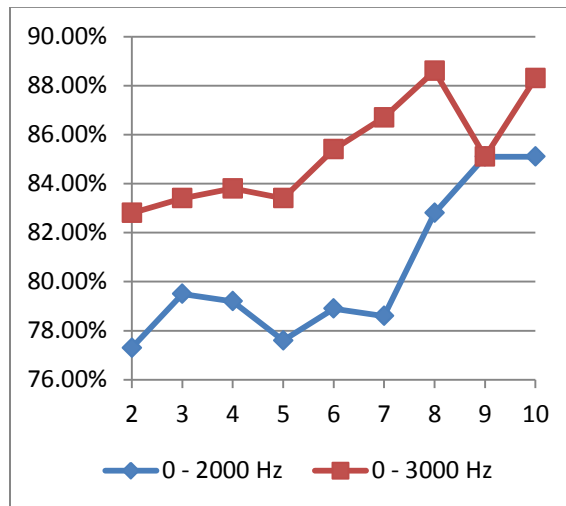

Figure 149: Male HR – RM Interview Session

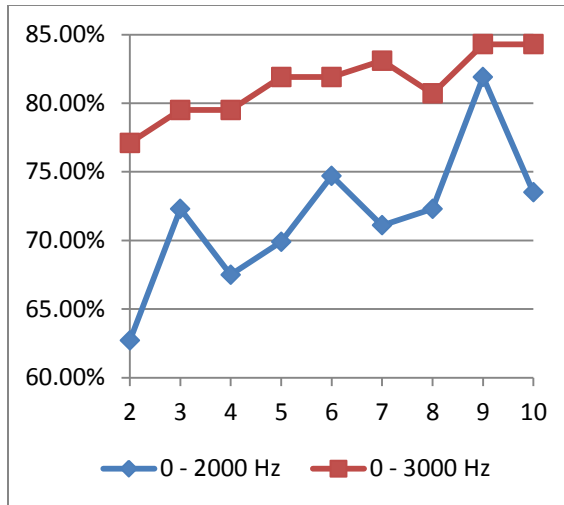

Figure 150: Male HR – RM Reading Session

For the reading session of the High Risk Suicidal – Remitted (HR-RM) pairwise group for the male patients using the quadratic classification; the classification rate of 0-3000 Hz frequency range is higher for all bands. Figure 150 above shows the classification results for different band numbers for the male HR-RM reading session having different band ranges using the quadratic classification.

Table 48 below shows all the best results that had been found for different pairwise groups with different classification methods and with different band frequency ranges for the male patients.

Table 48: The Best Band Number Results for the Male Patients with Different Band Frequency Ranges

MALE PATIENTS (0 – 2000 Hz)						
Pairwise Group	Optimized Band Numbers			Classification Rate		
	Linear	Cross Validated	Quadratic	Linear	Cross Validated	Quadratic
DP – HR Interview	9 bands	3 bands	3 bands	75.90%	75.20%	76.50%
DP – HR Reading	10 bands	10 bands	10 bands	76.00%	71.90%	78.10%
DP – RM Interview	8 bands	4 bands & 8 bands	9 bands	84.20%	82.30%	84.50%
DP – RM Reading	10 bands	6 bands	4 bands & 10 bands	75.80%	73.70%	75.80%
HR – RM Interview	9 bands & 10 bands	9 bands	9 bands & 10 bands	85.10%	84.40%	85.10%
HR – RM Reading	9 bands	9 bands	9 bands	81.90%	78.30%	81.90%
MALE PATIENTS (0 – 3000 Hz)						
Pairwise Group	Optimized Band Numbers			Classification Rate		
	Linear	Cross Validated	Quadratic	Linear	Cross Validated	Quadratic
DP – HR Interview	9 bands	9 bands	9 bands	81.30%	81.00%	81.30%
DP – HR Reading	9 bands	2 bands & 4 bands	2 bands & 9 bands	77.10%	74.00%	76.00%
DP – RM Interview	10 bands	9 bands	8 bands & 9 bands & 10 bands	83.40%	81.90%	82.60%
DP – RM Reading	5 bands & 10 bands	5 bands	5 bands & 10 bands	76.80%	73.70%	75.80%
HR – RM Interview	10 bands	8 bands	8 bands	89.00%	87.70%	88.60%
HR – RM Reading	10 bands	7 bands & 10 bands	9 bands & 10 bands	84.30%	80.70%	84.30%

3.2.3 Comparison of Classification Type with Different Band Ranges

In this research, three different types of classification method were used. They are linear discriminant classifier, quadratic discriminant classifier and cross validated discriminant classifier which is the leave-one-out classification method. In this

subchapter, these classification types that were used in this research will be compared. The following part will show the results of classification type comparisons.

3.2.3.1 Female Patients' Comparisons

When the classification type is compared for the Depressed – High Risk Suicidal (DP-HR) pairwise group for the female patients during the interview session, quadratic classifier in the 0-2000 Hz frequency range gave the best result except 3 bands. For 3 bands, linear and cross validated classifiers in the 0-2000 Hz frequency range gave the best result. Figure 151 shows the results below.

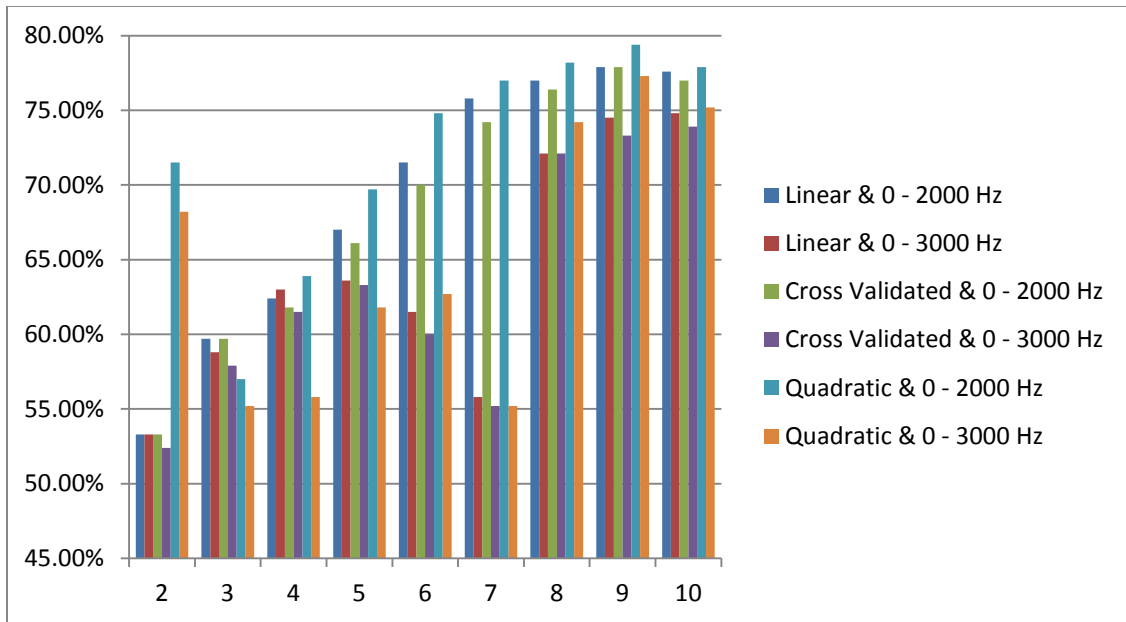

Figure 151: Classification Type Comparison Results for the DP – HR Pair of Female Patients Interview Session

Figure 152 shows the results for the Depressed – High Risk Suicidal (DP-HR) pairwise group for the female patients during the reading session. Linear classifier in the 0-2000 Hz frequency range gave the best result for 3 bands, 7 bands. Both the linear and the quadratic classifier in the 0-2000 Hz frequency range gave the best result for 6 bands. Quadratic classifier in the 0-3000 Hz frequency range gave the best result for 2 bands and 10 bands. Linear classifier in the 0-2000 Hz frequency range and quadratic classifier in the 0-3000 Hz frequency range gave the best result for 4 bands. Linear classifier in the 0-3000 Hz frequency range gave the best result for 5 bands. Linear classification in both frequency ranges gave good results for 8 bands. Linear and quadratic classifier in the 0-3000 Hz frequency range gave the best result for 9 bands.

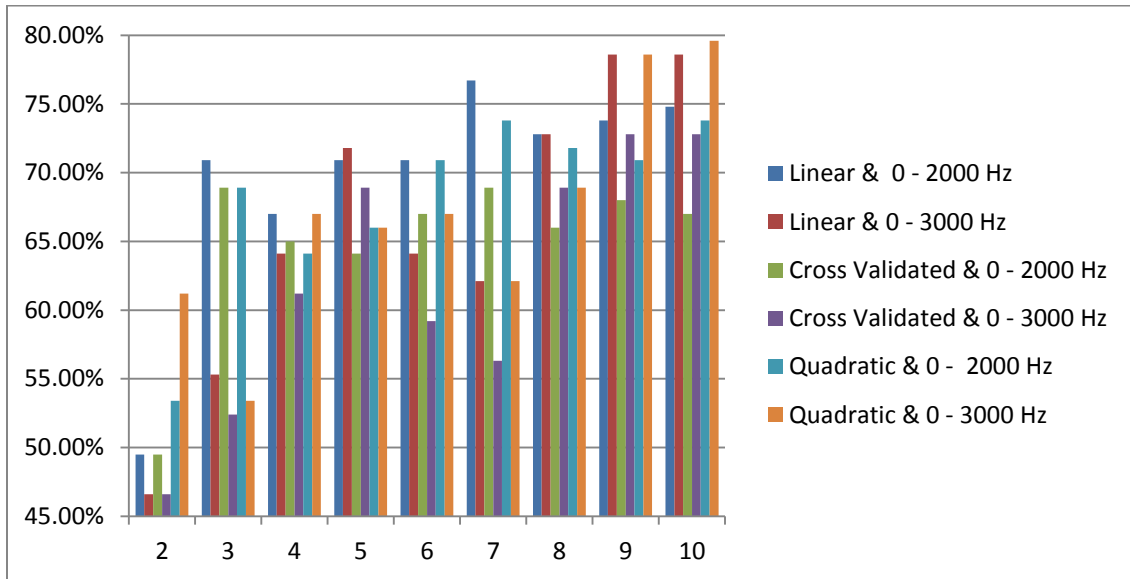

Figure 152: Classification Type Comparison Results for the DP – HR Pair of Female Patients Reading Session

Table 49 below shows all the results for the Depressed – High Risk Suicidal (DP-HR) pairwise group for the female patients during both sessions with different band ranges (0-2000 Hz and 0-3000 Hz). The highlighted classification methods are the classification methods that gave good classification results.

Table 49: The Best Classification Type Comparison Results for the DP – HR Pair of Female Patients

Band #	Female DP - HR Interview		Female DP - HR Reading	
	0 - 2000 Hz	0 - 3000 Hz	0 - 2000 Hz	0 - 3000 Hz
2	Quadratic	Quadratic	Quadratic	Quadratic
3	Linear & Cross	Linear & Cross	Linear	Linear
4	Quadratic	Linear	Linear	Quadratic
5	Quadratic	Linear & Cross	Linear	Linear
6	Quadratic	Linear & Quadratic	Linear & Quadratic	Quadratic
7	Quadratic	All best	Linear	Linear & Quadratic
8	Quadratic	Quadratic	Linear	Linear
9	Quadratic	Quadratic	Linear	Linear & Quadratic
10	Quadratic	All best	Linear	Linear & Quadratic

Quadratic classifier in the 0-2000 Hz frequency range gave the best result for all of the bands except 3 bands, when the classification type is compared for the Depressed – Remitted (DP-RM) pairwise group for the female patients during the interview session which is shown in Figure 153. For 3 bands, quadratic classifier in the 0-3000 Hz frequency range gave the best result.

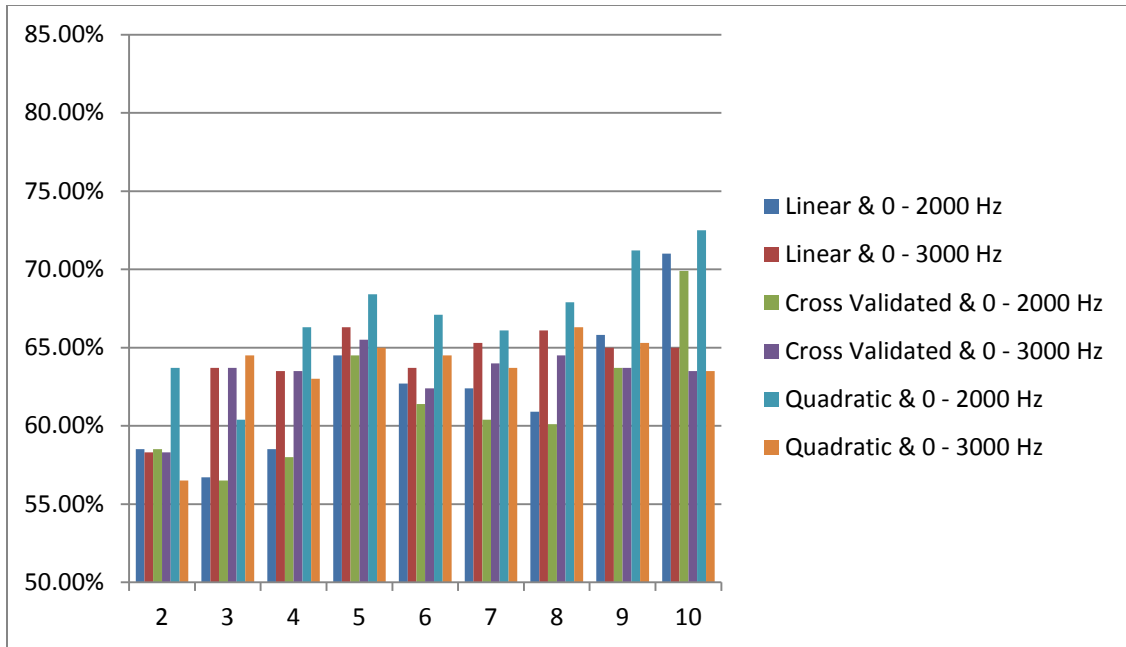

Figure 153: Classification Type Comparison Results for the DP – RM Pair of Female Patients Interview Session

Figure 154 shows the results for the Depressed – Remitted (DP-RM) pairwise group for the female patients during the reading session. Quadratic classifier in the 0-3000 Hz frequency range gave the best result for 10 bands, 9 bands. Linear classifier in the 0-3000 Hz frequency range gave the best result for 4 bands. Linear classifier in the 0-2000 Hz frequency range gave the best result for 3 bands, 6 bands, and 8 bands. Quadratic classifier in the 0-2000 Hz frequency range gave the best result for 5 bands, 7 bands, and 10 bands.

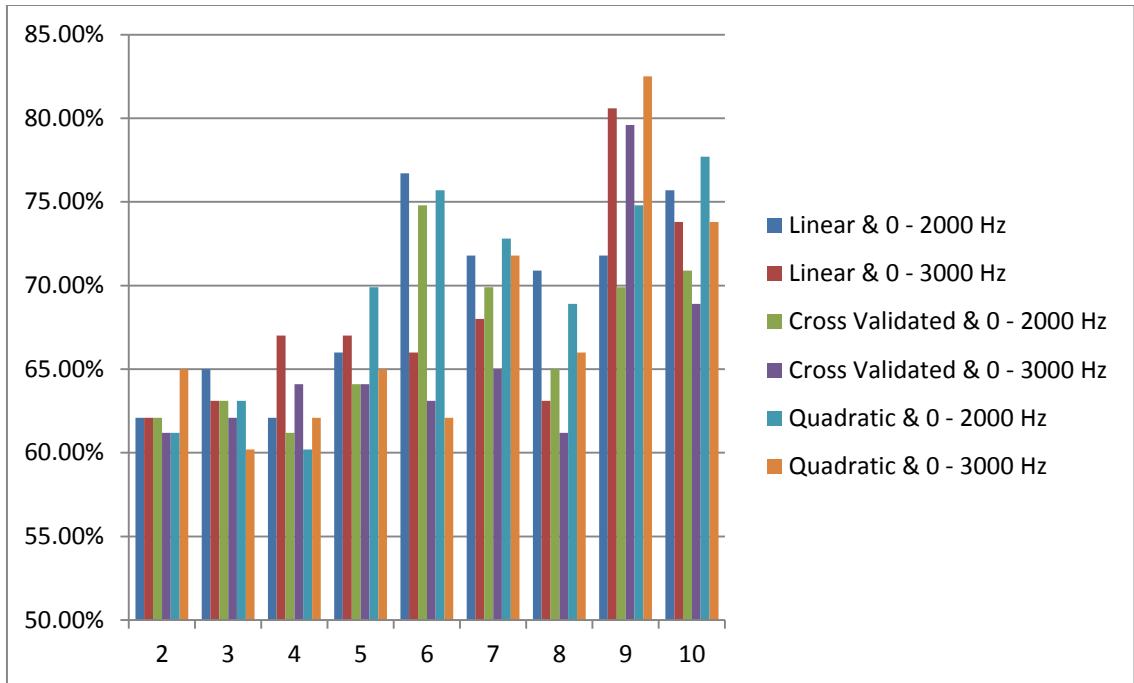

Figure 154: Classification Type Comparison Results for the DP – RM Pair of Female Patients Reading Session

The results for the Depressed – Remitted (DP-RM) pairwise group for the female patients during both sessions are shown in Table 50 below with different band ranges (0-2000 Hz and 0-3000 Hz). The highlighted classification methods are the classification methods that gave good classification results.

Table 50: The Best Classification Type Comparison Results for the DP – RM Pair of Female Patients

Band #	Female DP - RM Interview		Female DP - RM Reading	
	0 - 2000 Hz	0 - 3000 Hz	0 - 2000 Hz	0 - 3000 Hz
2	Quadratic	Linear & Cross	Linear & Cross	Quadratic
3	Quadratic	Quadratic	Linear	Linear & Cross
4	Quadratic	Linear & Cross	Linear	Linear
5	Quadratic	Linear	Quadratic	Linear
6	Quadratic	Quadratic	Linear	Linear
7	Quadratic	Linear	Quadratic	Quadratic
8	Quadratic	Linear & Quadratic	Linear	Quadratic
9	Quadratic	Linear & Quadratic	Quadratic	Quadratic
10	Quadratic	Linear	Quadratic	Linear & Quadratic

Figure 155 shows the results for the High Risk Suicidal – Remitted (HR-RM) pairwise group for the female patients during the interview session. Linear classifier in the 0-3000 Hz frequency range gave the best result for 5 bands and 8 bands. Linear classifier in the 0-2000 Hz frequency range gave the best result for 4 bands, 9 bands and 10 bands. Quadratic classifier in the 0-2000 Hz frequency range gave the best result for 2 bands. Linear and cross validated classifiers in the 0-2000 Hz frequency range gave good results for 3 bands, and 6 bands. Both the linear and the quadratic classifiers in the 0-2000 Hz frequency range gave good results for 7 bands.

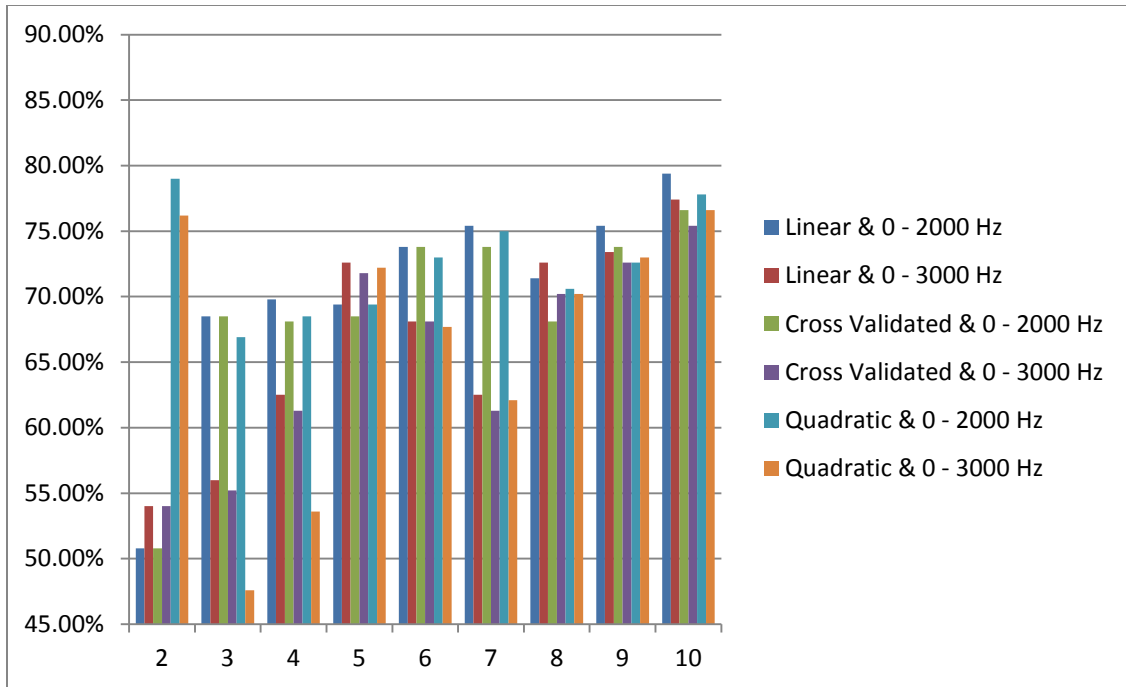

Figure 155: Classification Type Comparison Results for the HR – RM Pair of Female Patients Interview Session

High Risk Suicidal – Remitted (HR-RM) pairwise group for the female patients during the reading session was analyzed and the results are shown in Figure 156. Both the linear and the quadratic classifier in the 0-2000 Hz frequency range gave the best result for 7 bands, 8 bands, and 10 bands. Only the linear classifier in the 0-2000 Hz frequency range gave the best result for 3 bands, and 4 bands. Only the quadratic classifier in the 0-2000 Hz frequency range gave the best result for 6 bands. Linear classifier in the 0-3000 Hz frequency range gave the best result for 5 bands and 9 bands. Quadratic classifier in the 0-3000 Hz frequency range gave the best result for 2 bands.

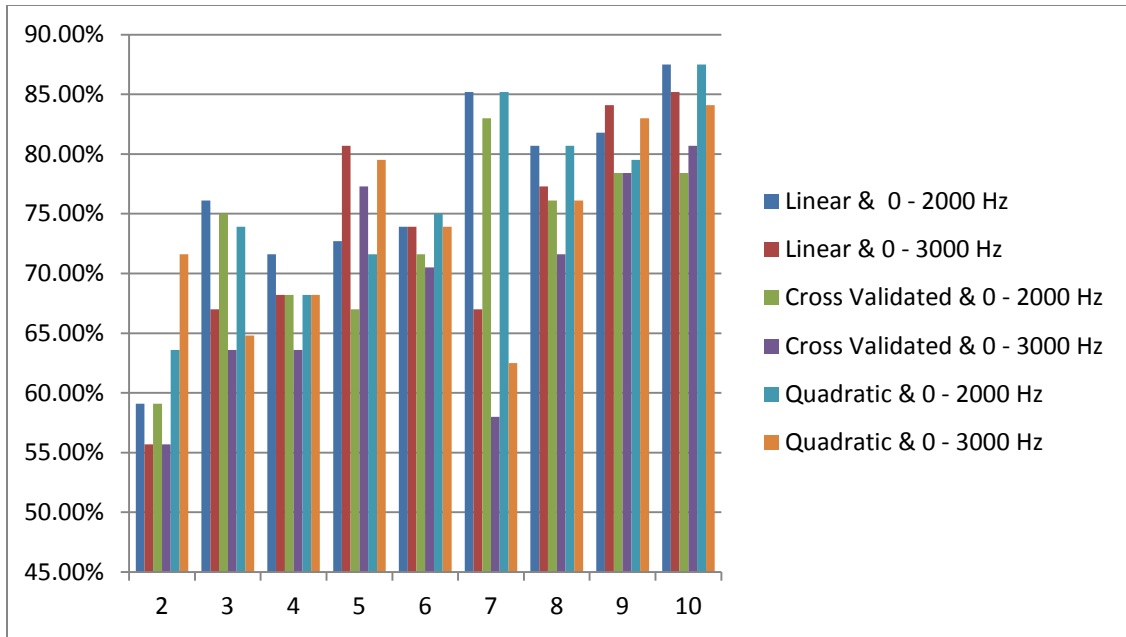

Figure 156: Classification Type Comparison Results for the HR – RM Pair of Female Patients Reading Session

The results for the High Risk Suicidal – Remitted (HR-RM) pairwise group for the female patients during both sessions are shown in Table 51 below with different band ranges (0-2000 Hz and 0-3000 Hz). The highlighted classification methods are the classification methods that gave good classification results.

Table 51: The Best Classification Type Comparison Results for the HR – RM Pair of Female Patients

Band #	Female HR - RM Interview		Female HR - RM Reading	
	0 - 2000 Hz	0 - 3000 Hz	0 - 2000 Hz	0 - 3000 Hz
2	Quadratic	Quadratic	Quadratic	Quadratic
3	Linear & Cross	Linear & Cross	Linear	Linear
4	Linear	Linear & Cross	Linear	Linear & Quadratic
5	All best	Linear	Linear & Quadratic	Linear & Quadratic
6	Linear & Cross	All best	Linear & Quadratic	Linear & Quadratic
7	Linear & Quadratic	All best	Linear & Quadratic	Linear
8	Linear & Quadratic	Linear	Linear & Quadratic	Linear
9	Linear	All best	Linear	Linear
10	Linear	All best	Linear & Quadratic	Linear

3.2.3.2 Male Patients' Comparisons

When the classification type is compared for the Depressed – High Risk Suicidal (DP-HR) pairwise group for the male patients during the interview session, classifiers in the 0-3000 Hz frequency range gave the best result for all of the bands as shown in Figure 157. Linear and cross validated classifiers (0-3000 Hz) gave good results in 2 bands; linear and quadratic classifiers (0-3000 Hz) gave good results in 6 bands, 7 bands, 8 bands, and 9 bands. Only the quadratic classifier (0-3000 Hz) gave good results in 4 bands and 10 bands. All three classifiers in the 0-3000 Hz frequency range gave good results for 3 bands and 5 bands.

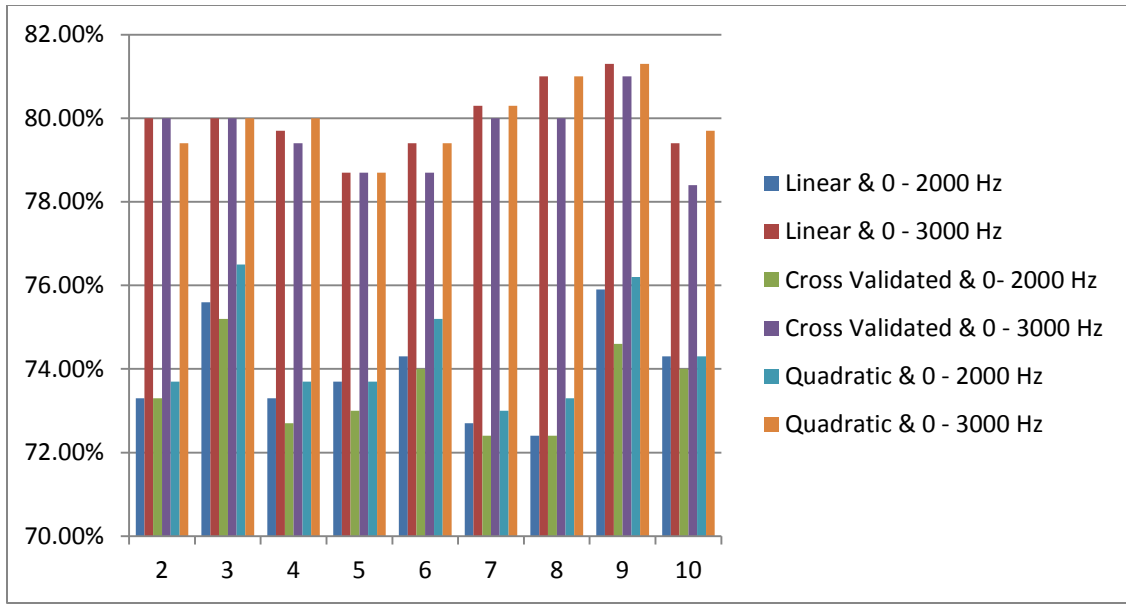

Figure 157: Classification Type Comparison Results for the DP– HR Pair of Male Patients Interview Session

Figure 158 shows the results for the Depressed – High Risk Suicidal (DP-HR) pairwise group for the male patients during the reading session. Quadratic classifier in the 0-3000 Hz frequency range gave the best result for 2 bands, 5 bands and 6 bands. Quadratic classifier in the 0-2000 Hz frequency range gave the best result for 7 bands, 10 bands. For 3 bands and 4 bands, both the linear and the quadratic classifiers in the 0-3000 Hz frequency range gave the same good result. Linear classifier in the 0-3000 Hz frequency range gave good result for 8 bands and 9 bands.

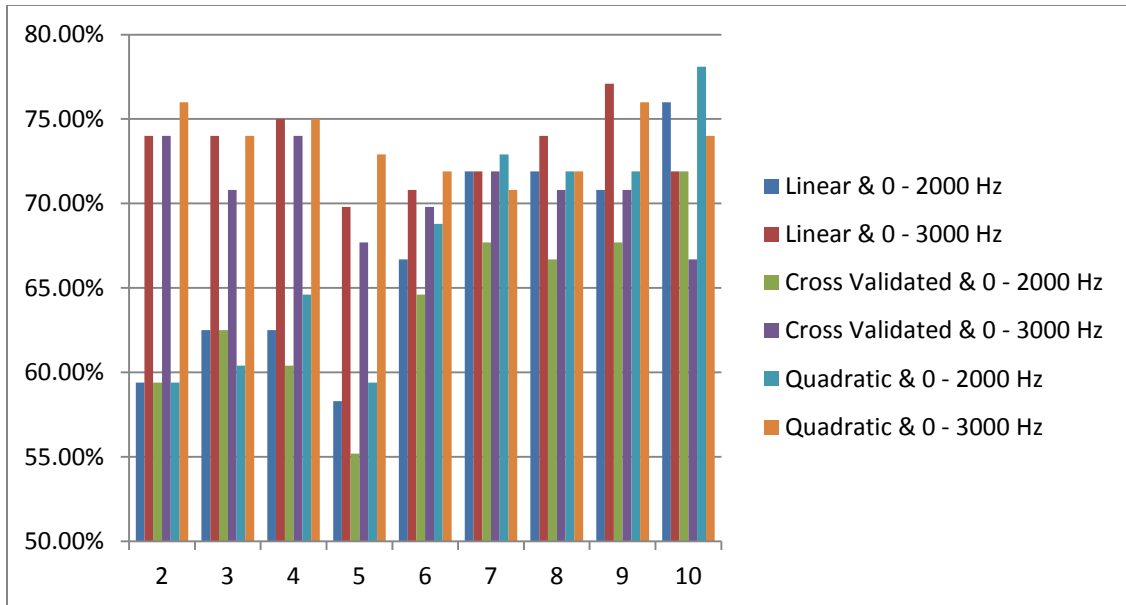

Figure 158: Classification Type Comparison Results for the DP– HR Pair of Male Patients Reading Session

Table 52 below shows all the results for the Depressed – High Risk Suicidal (DP-HR) pairwise group for the male patients during both sessions with different band ranges (0-2000 Hz and 0-3000 Hz). The highlighted classification methods are the classification methods that gave good classification results.

Table 52: The Best Classification Type Comparison Results for the DP – HR Pair of Male Patients

Band #	Male DP - HR Interview		Male DP - HR Reading	
	0 - 2000 Hz	0 - 3000 Hz	0 - 2000 Hz	0 - 3000 Hz
2	Quadratic	Linear & Cross	All best	Quadratic
3	Quadratic	All best	Linear & Cross	Linear & Quadratic
4	Quadratic	Quadratic	Quadratic	Linear & Quadratic
5	Quadratic	All best	Quadratic	Quadratic
6	Quadratic	Linear & Quadratic	Quadratic	Quadratic
7	Quadratic	Linear & Quadratic	Quadratic	Linear & Cross
8	Quadratic	Linear & Quadratic	Linear & Quadratic	Linear
9	Quadratic	Linear & Quadratic	Quadratic	Linear
10	Quadratic	Quadratic	Quadratic	Quadratic

When the classification type is compared for the Depressed – Remitted (DP-RM) pairwise group for the male patients during the interview session which is shown in Figure 159, all three classifier in the 0-2000 Hz frequency range gave the best result for 4 bands, 5 bands, and 7 bands. Quadratic classifier in the 0-2000 Hz frequency range gave good result for 2 bands, 6 bands, and 9 bands. For 10 bands, quadratic in the 0-2000 Hz range and linear in the 0-3000 Hz range classifiers both gave same good classification result. All three classifiers in the 0-3000 Hz frequency range gave the best result for 3 bands.

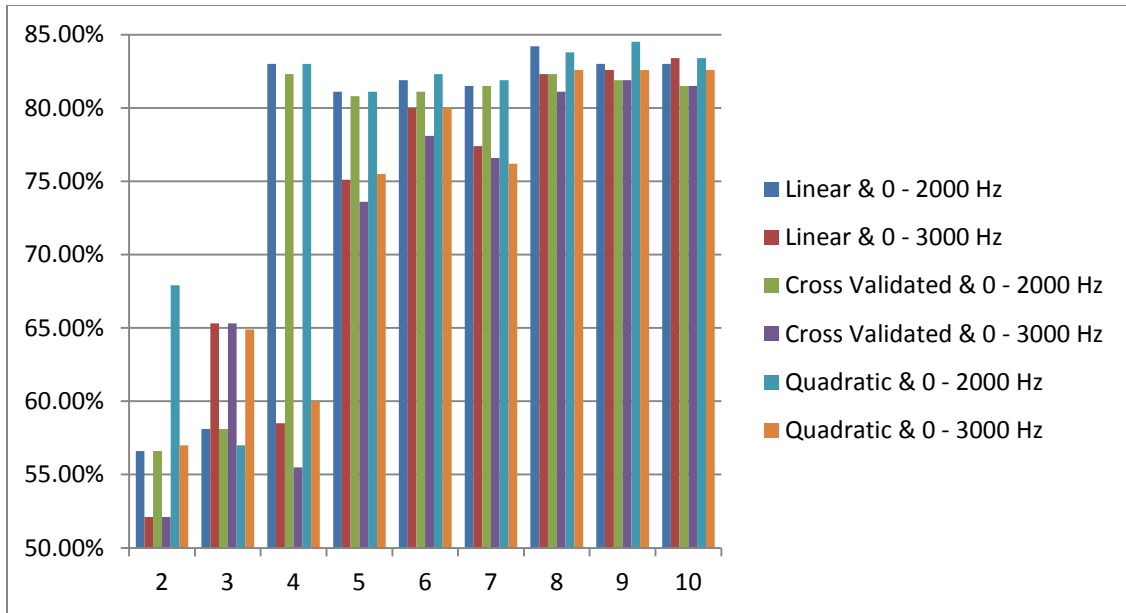

Figure 159: Classification Type Comparison Results for the DP– RM Pair of Male Patients Interview Session

Figure 160 shows the results for the Depressed – Remitted (DP-RM) pairwise group for the male patients during the reading session. Quadratic classifier in the 0-2000 Hz gave the best result for 4 bands, and quadratic classifier in the 0-3000 Hz gave the best result for 2 bands. Linear classifier in the 0-2000 Hz range gave the best result for 9 bands. For 6 bands, both the linear classifiers in the 0-2000 Hz range and the 0-3000 Hz range gave the same good discrimination result. Linear classifier in the 0-3000 Hz range gave the best result for 5 bands, 8 bands, and 10 bands. Both the linear and the quadratic classifiers in the 0-3000 Hz frequency range gave good result in the 7 bands. For the 3 bands, all three classifiers gave the best result.

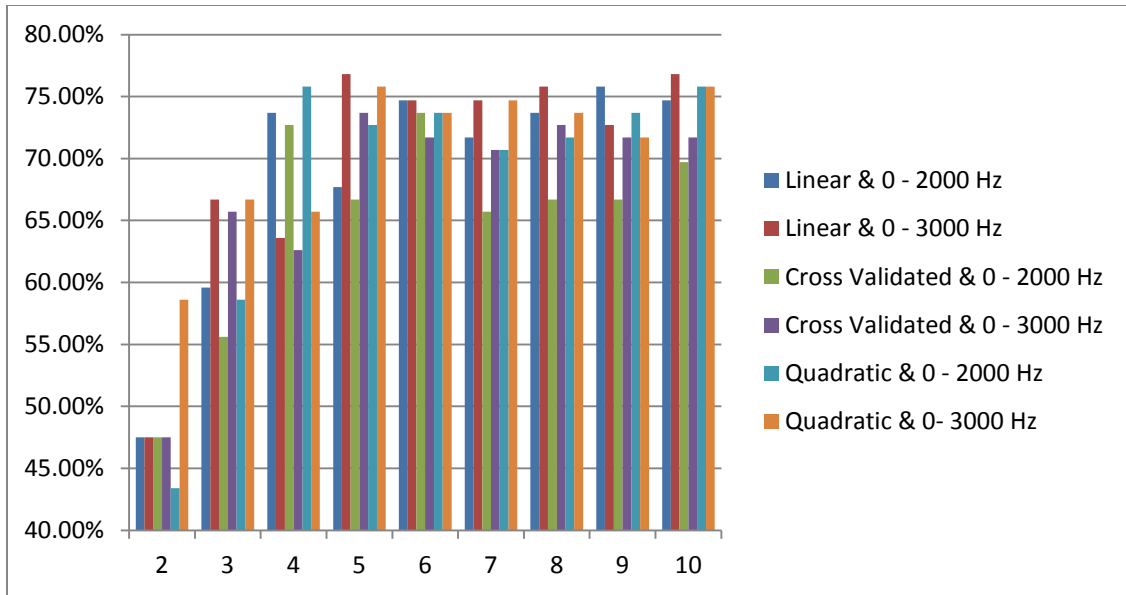

Figure 160: Classification Type Comparison Results for the DP– RM Pair of Male Patients Reading Session

The results for the Depressed – Remitted (DP-RM) pairwise group for the male patients during both sessions are shown in Table 53 below with different band ranges (0-2000 Hz and 0-3000 Hz). The highlighted classification methods are the classification methods that gave good classification results.

Table 53: The Best Classification Type Comparison Results for the DP – RM Pair of Male Patients

Band #	Male DP - RM Interview		Male DP - RM Reading	
	0 - 2000 Hz	0 - 3000 Hz	0 - 2000 Hz	0 - 3000 Hz
2	Quadratic	Quadratic	Linear & Cross	Linear & Quadratic
3	Linear & Cross	All Best	Linear & Quadratic	All Best
4	All Best	Quadratic	Quadratic	Quadratic
5	All Best	Linear & Quadratic	Quadratic	Linear
6	Quadratic	Linear & Quadratic	Linear & Cross & Quadratic	Linear
7	All Best	All Best	Linear	Linear & Quadratic
8	Linear & Quadratic	Linear & Quadratic	Linear	Linear
9	Quadratic	All Best	Linear	All Best
10	Linear & Quadratic	Linear	Quadratic	Linear

Figure 161 shows the results for the High Risk Suicidal – Remitted (HR-RM) pairwise group for the male patients during the interview session. The quadratic classifier in the 0-3000 Hz frequency range gave the best result for 3 bands, 8 bands and 9 bands. For 9 bands, linear and quadratic classifiers in the 0-2000 Hz frequency range also gave same good classification rates like quadratic classifier in the 0-3000 Hz frequency range. Linear and quadratic classifiers in the 0-3000 Hz frequency range are the best classifiers for 5 bands and 7 bands. All classifiers in the 0-3000 Hz gave the same good result for the 2 bands. Linear and cross validated classifier in the 0-3000 Hz frequency range gave the best result for 4 bands. Only the linear classifier in the 0-3000 Hz frequency range gave the best result for 6 bands and 10 bands.

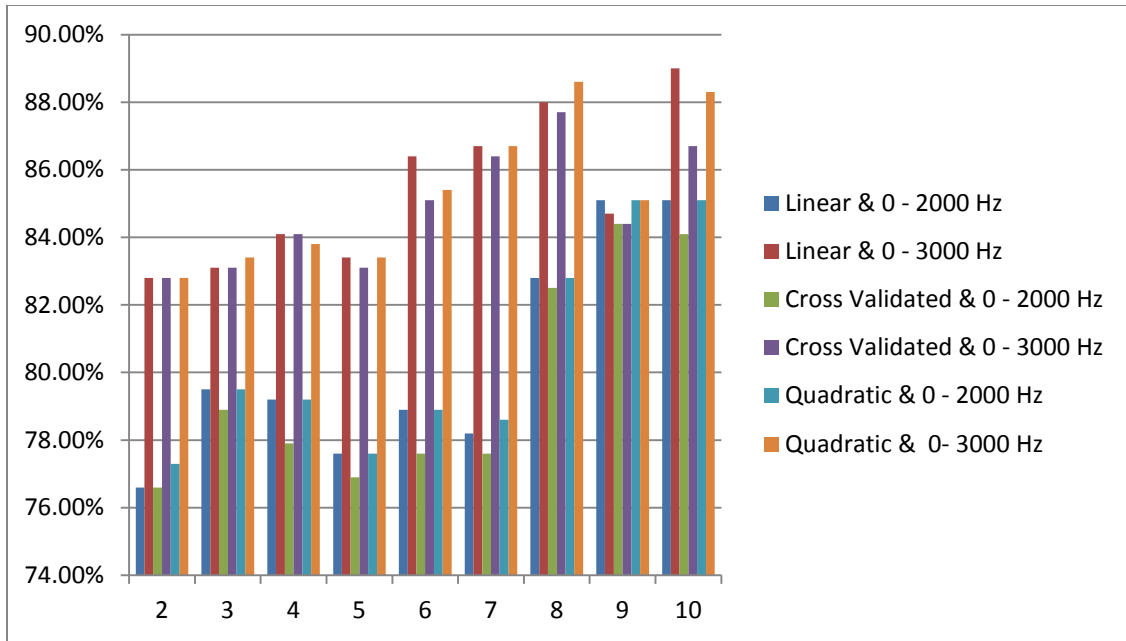

Figure 161: Classification Type Comparison Results for the HR– RM Pair of Male Patients Interview Session

High Risk Suicidal – Remitted (HR-RM) pairwise group for the male patients during the reading session was analyzed and the results are shown in Figure 162. All of the bands were better classified with classifiers in the 0-3000 Hz frequency bands. Quadratic classifiers in the 0-3000 Hz frequency bands 3 bands, 6 bands, 7 bands, 8 bands, and 9 bands. Only the linear classifier gave the best result in the 0-3000 Hz frequency bands for 4 bands. Both the linear and the quadratic classifier gave the best result for 5 bands, and 10 bands. Both the linear and the cross validated classifier gave the best result for 2 bands.

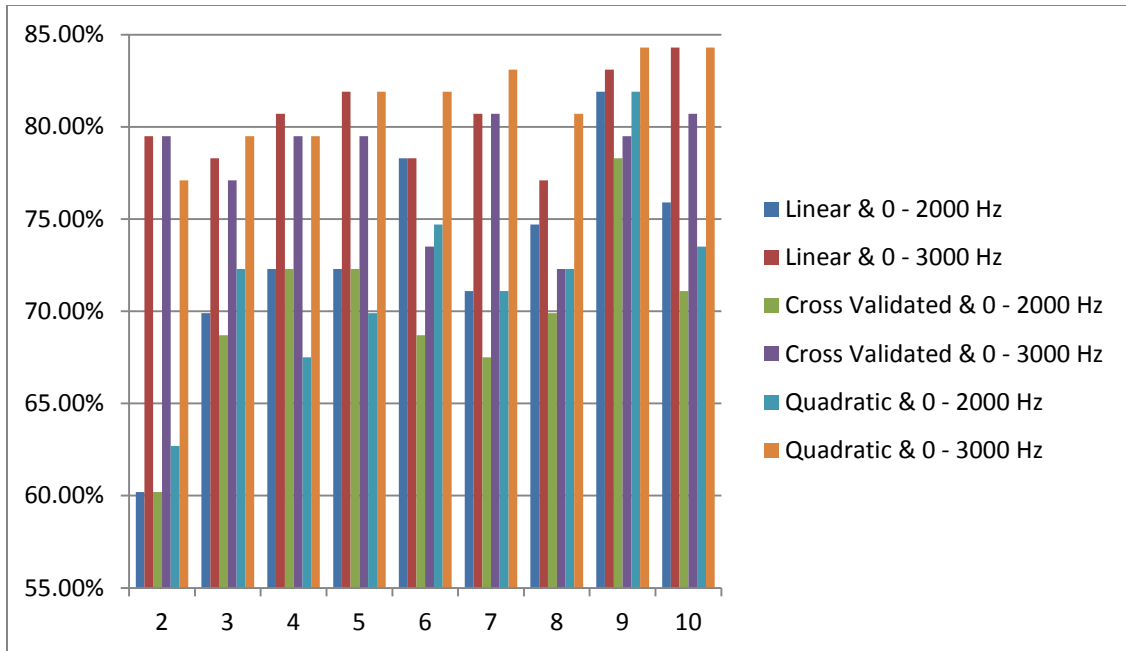

Figure 162: Classification Type Comparison Results for the HR– RM Pair of Male Patients Reading Session

The results for the High Risk Suicidal – Remitted (HR-RM) pairwise group for the male patients during both sessions are shown in Table 54 below with different band ranges (0-2000 Hz and 0-3000 Hz). The highlighted classification methods are the classification methods that gave good classification results.

Table 54: The Best Classification Type Comparison Results for the HR – RM Pair of Male Patients

Band #	Male HR - RM Interview		Male HR - RM Reading	
	0 - 2000 Hz	0 - 3000 Hz	0 - 2000 Hz	0 - 3000 Hz
2	Quadratic	All Best	Quadratic	Linear & Cross
3	Linear & Quadratic	Quadratic	Quadratic	Quadratic
4	Linear & Quadratic	Linear & Cross	Linear & Cross	Linear
5	Linear & Quadratic	Linear & Quadratic	Linear & Cross	Linear & Quadratic
6	Linear & Quadratic	Linear	Linear	Quadratic
7	Quadratic	Linear & Quadratic	Linear & Quadratic	Quadratic
8	All Best	Quadratic	Linear	Quadratic
9	Linear & Quadratic	Quadratic	Linear & Quadratic	Quadratic
10	Linear & Quadratic	Linear	Linear	Linear & Quadratic

3.2.4 Comparison of Interview and Reading Sessions with Different Band Ranges

Two different types of speech samples were used in this research. They are speech samples from the spontaneous speech during the clinical interview with a psychiatrist (interview session) and speech samples that was gathered while the patients were reading a predetermined part of a book named (reading session). This sub-chapter will show the results of different session comparisons with different frequency ranges of 0-2000 Hz and 0-3000 Hz.

3.2.4.1 Female Patients' Comparisons

When interview session and reading session is compared for the Depressed – High Risk Suicidal (DP-HR) pairwise group for the female patients using the linear classification with using the different band ranges, both the interview session in the 0-2000 Hz and the 0-3000 Hz frequency range gave the best result for 2 bands. Reading

session gave the best result for 3 bands, 4 bands, and 7 bands for 0-2000 Hz frequency range. Interview session in the 0-2000 Hz frequency range gave the best classification result for 6 bands and 8 bands. Reading session gave the best result for 5 bands, 9 bands, and 10 bands for 0-3000 Hz frequency range. These results can be seen in Figure 163 below.

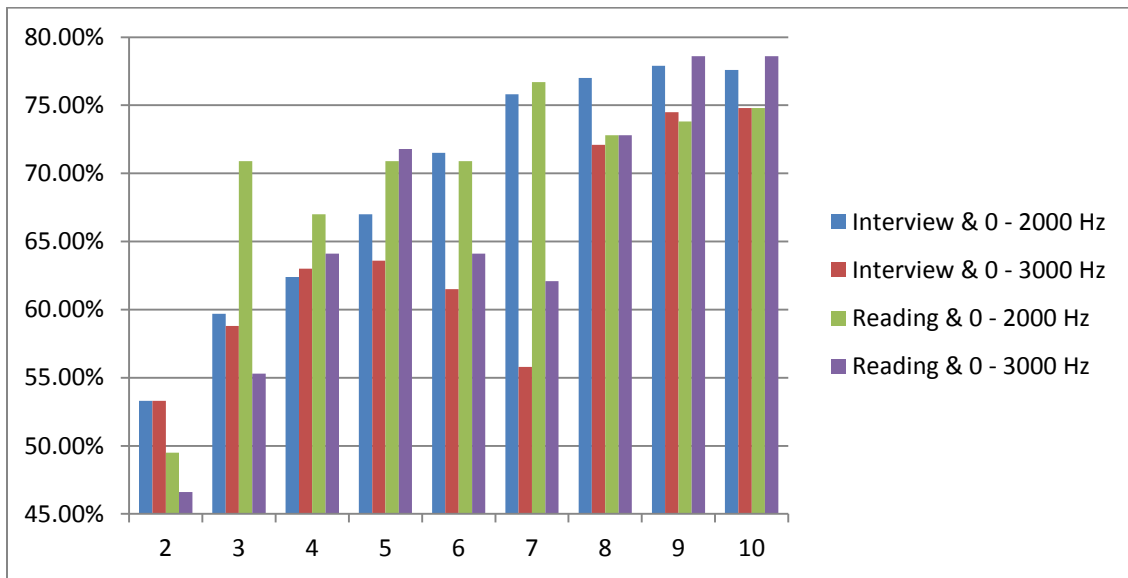

Figure 163: Comparison of Sessions for the Female DP – HR with Linear Classification

For the Depressed – High Risk Suicidal (DP-HR) pairwise group for the female patients using the cross validated classification, interview session gave the best result for bands 2 bands, 6 bands, 7 bands, 8 bands, 9 bands, 10 bands in the 0-2000 Hz frequency range. Reading session in the 0-2000 Hz frequency range gave the best result for bands 3 bands, 4 bands. For 5 bands, reading session in the 0-3000 Hz frequency range gave the best result. These results can be seen in Figure 164 below.

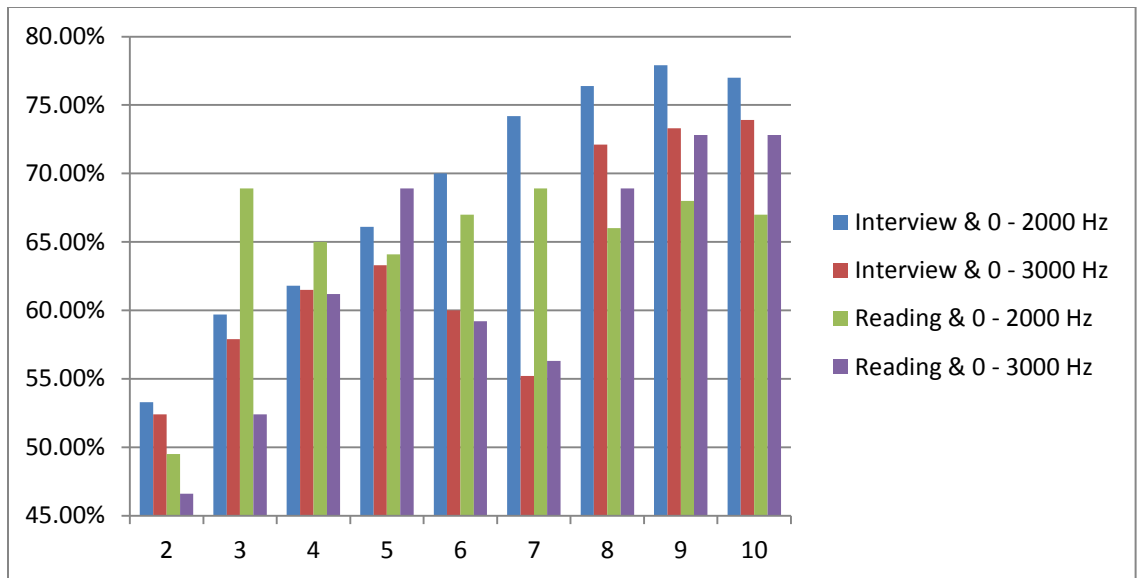

Figure 164: Comparison of Sessions for the Female DP – HR with Cross Validated Classification

For the Depressed – High Risk Suicidal (DP-HR) pairwise group for the female patients using the quadratic classification, interview session in the 0-2000 Hz gave the best result for 2 bands, 5 bands, 6 bands, 7 bands, 8 bands, and 9 bands. Reading session in the 0-2000 Hz gave the best result for 3 bands. Finally, reading session in the 0-3000 Hz gave the best result for 4 bands and 10 bands. These results can be seen in Figure 165 below.

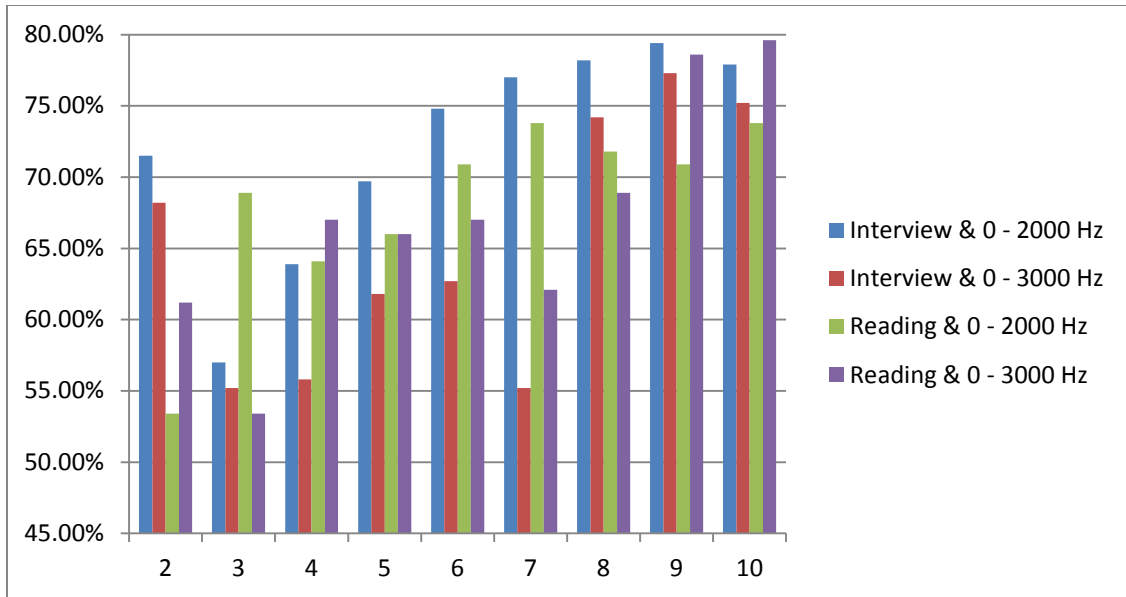

Figure 165: Comparison of Sessions for the Female DP – HR with Quadratic Classification

All of the results about different session comparisons are shown in Table 55 below for the Depressed – High Risk Suicidal (DP-HR) pairwise group for the female patients with different band ranges (0-2000 Hz and 0-3000 Hz).. The highlighted sessions are the sessions that gave good classification results for the specific classification methods.

Table 55: Session Type Comparison Results for the DP – HR Pair of Female Patients with Different Band Ranges

FEMALE DP - HR PAIR						
Band #	LINEAR		CROSS VALIDATED		QUADRATIC	
	0 - 2000	0 - 3000	0 - 2000	0 - 3000	0 - 2000	0 - 3000
2	Interview	Interview	Interview	Interview	Interview	Interview
3	Reading	Interview	Reading	Interview	Reading	Interview
4	Reading	Both best	Reading	Both best	Both best	Reading
5	Reading	Reading	Interview	Reading	Interview	Reading
6	Interview & Reading	Reading	Interview	Both best	Interview	Reading
7	Interview & Reading	Reading	Interview	Both best	Interview	Reading
8	Interview	Both best	Interview	Interview	Interview	Interview
9	Interview	Reading	Interview	Both best	Interview	Both best
10	Interview	Reading	Interview	Both best	Interview	Reading

When interview session and reading session is compared for the Depressed – Remitted (DP-RM) pairwise group for the female patients using the linear classification, reading session in the 0-2000 Hz gave the best result for all results except 2 bands, 4 bands, 5 bands, and 9 bands. For these bands, reading session in the 0-3000 Hz gave the best result. These results can be seen in Figure 166 below.

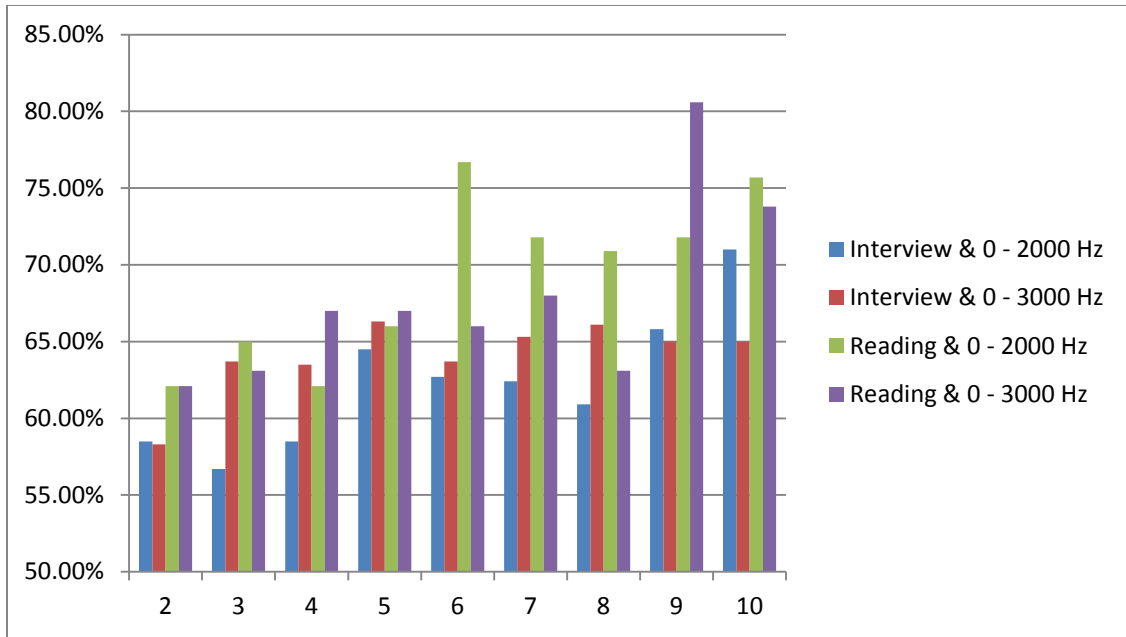

Figure 166: Comparison of Sessions for the Female DP – RM with Linear Classification

For the Depressed – Remitted (DP-RM) pairwise group for the female patients using the cross validated classification, the reading session in the 0-2000 Hz frequency range gave the best result for 2 bands, 6 bands, 7 bands, 8 bands, and 10 bands. The interview session in the 0-3000 Hz frequency range gave the best result for 3 bands and 5 bands. Reading session in the 0-3000 Hz frequency range gave the best result for 4 bands and 9 bands. These results can be seen in Figure 167 below.

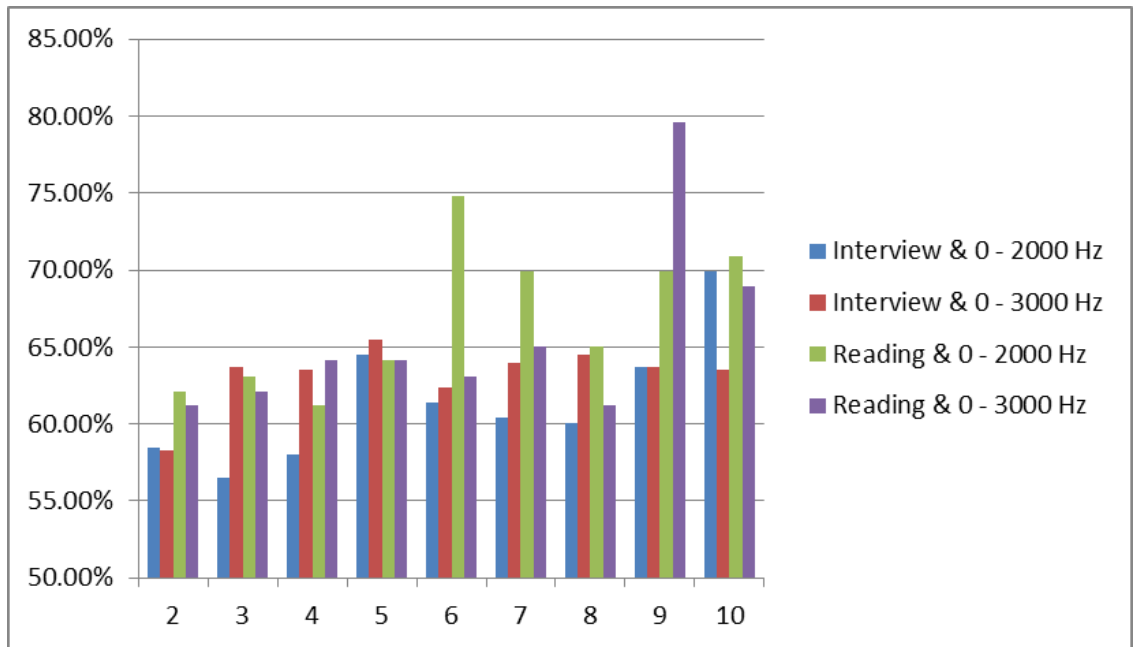

Figure 167: Comparison of Sessions for the Female DP – RM with Cross Validated Classification

For the Depressed – Remitted (DP-RM) pairwise group for the female patients using the quadratic classification, reading session in the 0-2000 Hz frequency range gave the best result for 5 bands, 6 bands, 7 bands, 8 bands, and 10 bands. The interview session in the 0-2000 Hz frequency range gave the best result for 4 bands, and interview session in the 0-3000 Hz frequency range gave the best result for 3 bands. Reading session in the 0-3000 Hz frequency range gave the best result for 2 bands and 9 bands. These results can be seen in Figure 168 below.

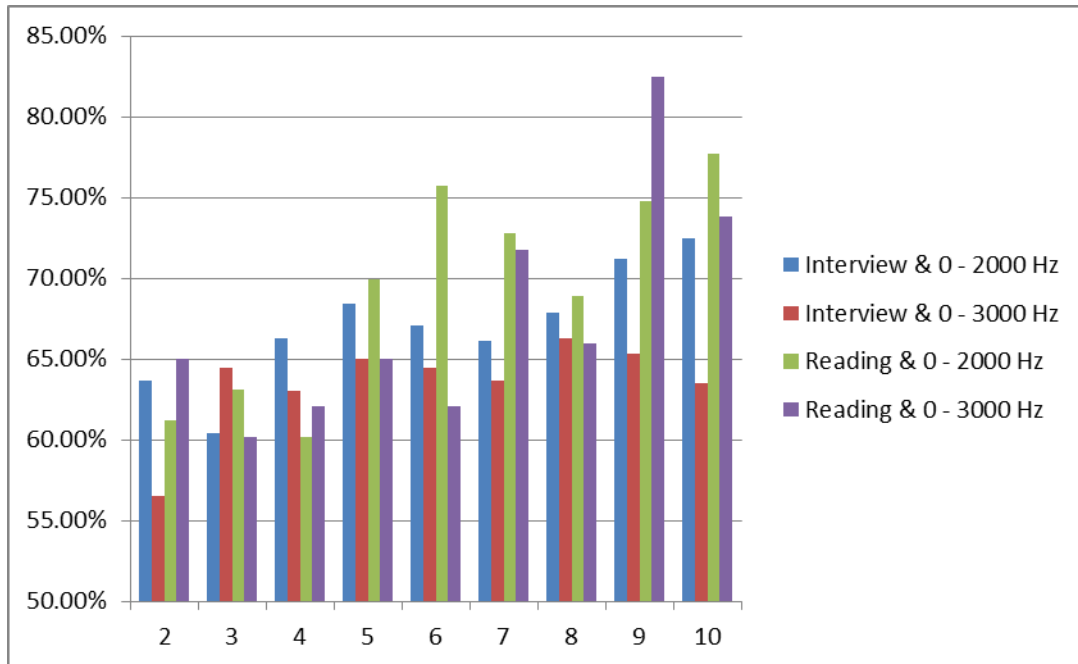

Figure 168: Comparison of Sessions for the Female DP – RM with Quadratic Classification

All of the results about different session comparisons are shown in Table 56 below for the Depressed – Remitted (DP-RM) pairwise group for the female patients with different band ranges (0-2000 Hz and 0-3000 Hz). The highlighted sessions are the sessions that gave good classification results for the specific classification methods.

Table 56: Session Type Comparison Results for the DP – RM Pair of Female Patients with Different Band Ranges

FEMALE DP - RM PAIR						
	LINEAR		CROSS VALIDATED		QUADRATIC	
Band #	0 - 2000	0 - 3000	0 - 2000	0 - 3000	0 - 2000	0 - 3000
2	Reading	Reading	Reading	Reading	Interview	Reading
3	Reading	Both best	Reading	Interview	Reading	Interview
4	Reading	Reading	Reading	Reading	Interview	Both best
5	Reading	Reading	Both best	Interview	Reading	Both best
6	Reading	Reading	Reading	Both best	Reading	Interview
7	Reading	Reading	Reading	Both best	Reading	Reading
8	Reading	Interview	Reading	Interview	Reading	Both best
9	Reading	Reading	Reading	Reading	Reading	Reading
10	Reading	Reading	Reading	Reading	Reading	Reading

When the interview session and the reading session is compared for the High Risk Suicidal – Remitted (HR-RM) pairwise group for the female patients using the linear classification, reading session in the 0-2000 Hz frequency range gave the best results for all bands except 5 bands, 6 bands, and 9 bands. Both sessions in the 0-2000 Hz and the reading session in the 0-3000 Hz frequency range gave the same best result for 6 bands. Reading session in the 0-3000 Hz frequency range gave the best results for 5 bands and 9 bands. These results can be seen in Figure 169 below.

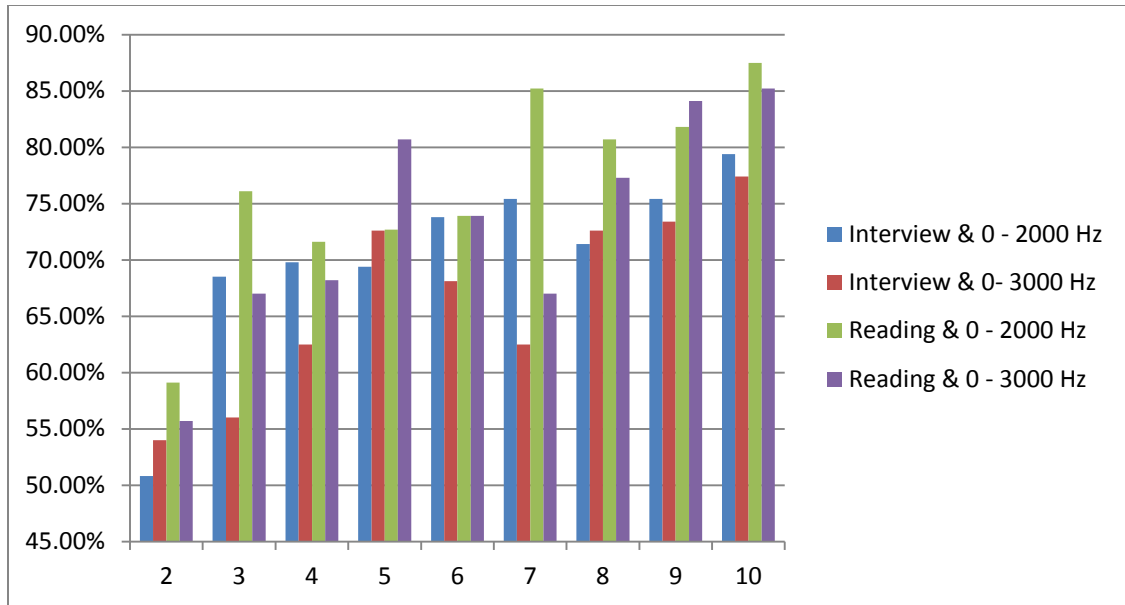

Figure 169: Comparison of Sessions for the Female HR – RM with Linear Classification

For the High Risk Suicidal – Remitted (HR-RM) pairwise group for the female patients using the cross validated classification, reading session in the 0-2000 Hz frequency range gave the best result for 2 bands, 3 bands, 7 bands, 8 bands. Both sessions in the 0-2000 Hz frequency range gave the same best result for 4 bands. The interview in the 0-2000 Hz frequency range gave the best result for 6 bands. The reading session in the 0-3000 Hz frequency range gave the best result for 5 bands and 10 bands. Both reading sessions in the 0-2000 Hz and the 0-3000 Hz gave good results for 9 bands. These results can be seen in Figure 170 below.

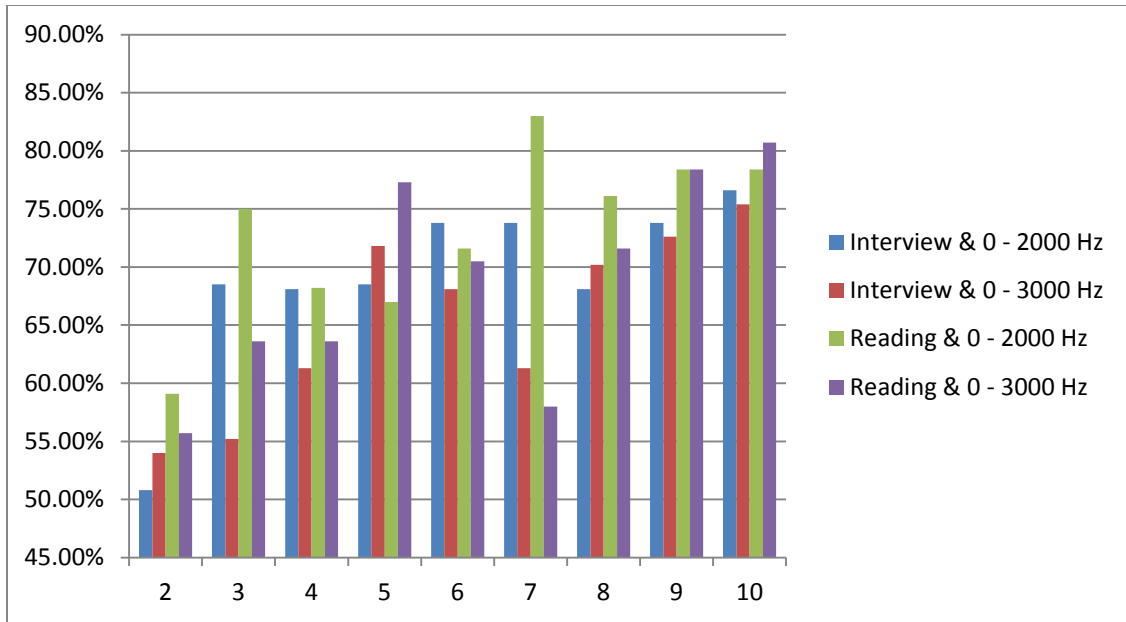

Figure 170: Comparison of Sessions for the Female HR – RM with Cross Validated Classification

For the High Risk Suicidal – Remitted (HR-RM) pairwise group for the female patients using the quadratic classification, interview session in the 0-2000 Hz gave the best result for 2 bands, 4 bands. The reading session in the 0-2000 Hz gave the best results for 3 bands, 6 bands, 7 bands, 8 bands, and 10 bands. The reading session in the 0-3000 Hz gave the best results for 5 bands and 9 bands. These results can be seen in Figure 171 below.

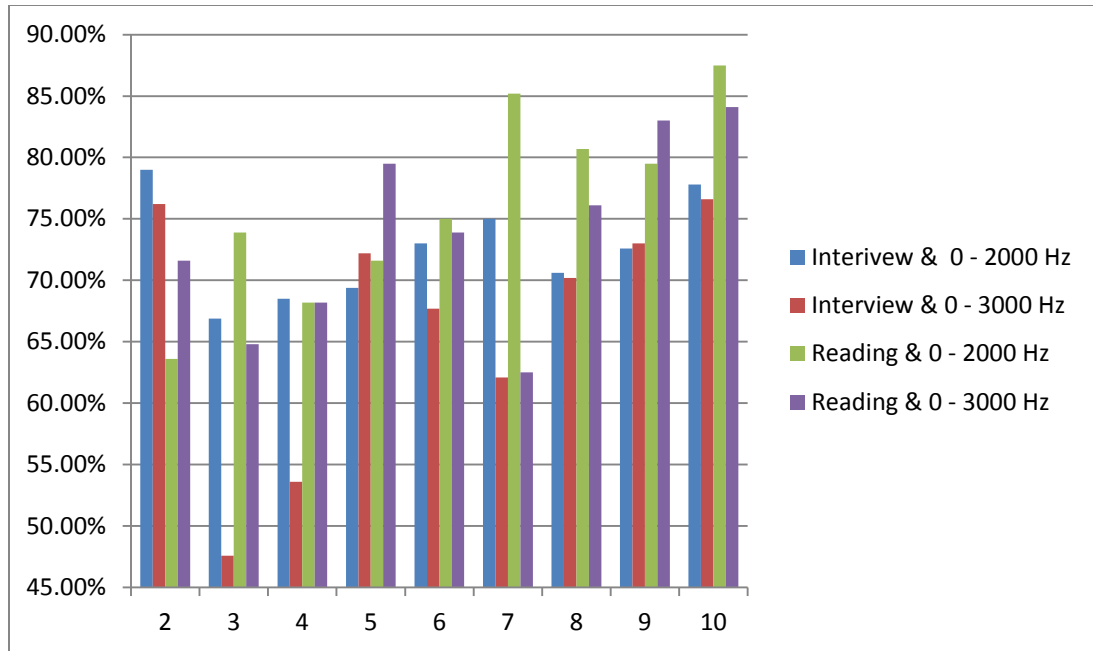

Figure 171: Comparison of Sessions for the Female HR – RM with Quadratic Classification

All of the results about different session comparisons are shown in Table 57 below for the High Risk Suicidal – Remitted (HR-RM) pairwise group for the female patients with different band ranges (0-2000 Hz and 0-3000 Hz). The highlighted sessions are the sessions that gave good classification results for the specific classification methods.

Table 57: Session Type Comparison Results for the HR – RM Pair of Female Patients with Different Band Ranges

FEMALE HR – RM PAIR						
Band #	LINEAR		CROSS VALIDATED		QUADRATIC	
	0 - 2000	0 - 3000	0 - 2000	0 - 3000	0 - 2000	0 - 3000
2	Reading	About same but Reading	Reading	Reading	Interview	Interview
3	Reading	Reading	Reading	Reading	Reading	Reading
4	Reading	Reading	Both best	Reading	Interview	Reading
5	Reading	Reading	Interview	Reading	Reading	Reading
6	Both best	Reading	Interview	Reading	Reading	Reading
7	Reading	Reading	Reading	Interview	Reading	Both best
8	Reading	Reading	Reading	About same but Reading	Reading	Reading
9	Reading	Reading	Reading	Reading	Reading	Reading
10	Reading	Reading	Reading	Reading	Reading	Reading

3.2.4.2 Male Patients' Comparisons

When the interview session and the reading session is compared for the Depressed – High Risk Suicidal (DP-HR) pairwise group for the male patients using the linear classification, interview session in the 0-3000 Hz frequency range gave the best result for all bands. These results can be seen in the Figure 172 below.

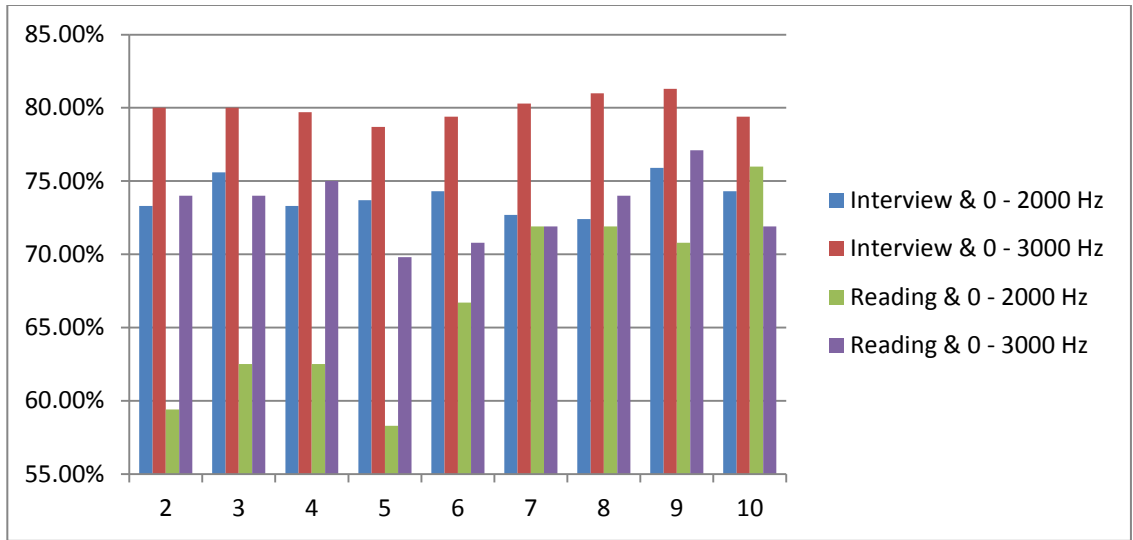

Figure 172: Comparison of Sessions for the Male DP – HR with Linear Classification

For the Depressed – High Risk Suicidal (DP-HR) pairwise group for the male patients using the cross validated classification; interview session in the 0-3000 Hz frequency band gave the best result for all bands. These results can be seen in Figure 173 below.

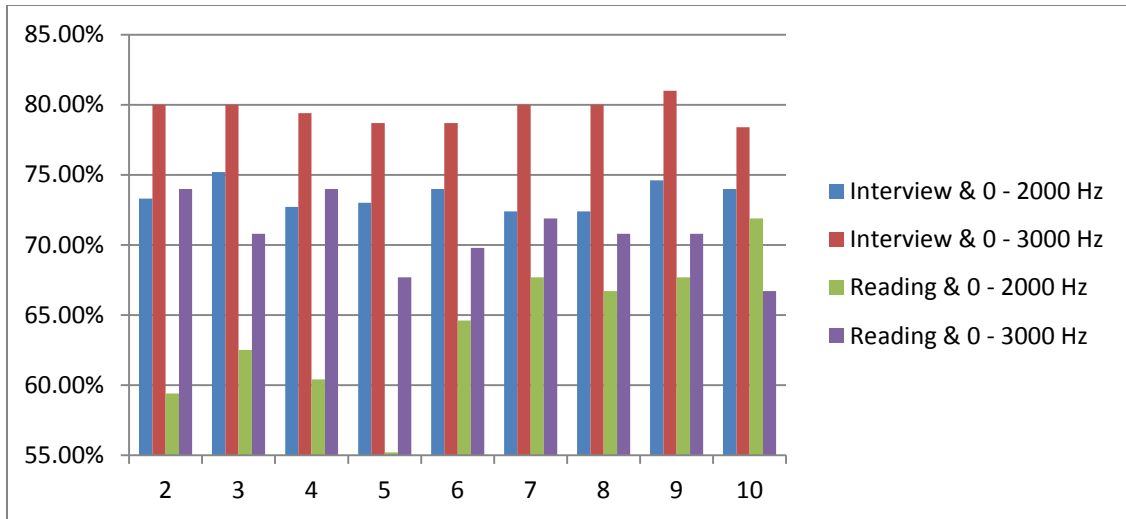

Figure 173: Comparison of Sessions for the Male DP – HR with Cross Validated Classification

For the Depressed – High Risk Suicidal (DP-HR) pairwise group for the male patients using the quadratic classification, interview session in the 0-3000 Hz frequency range gave the best result for all bands. These results can be seen in the Figure 174 below.

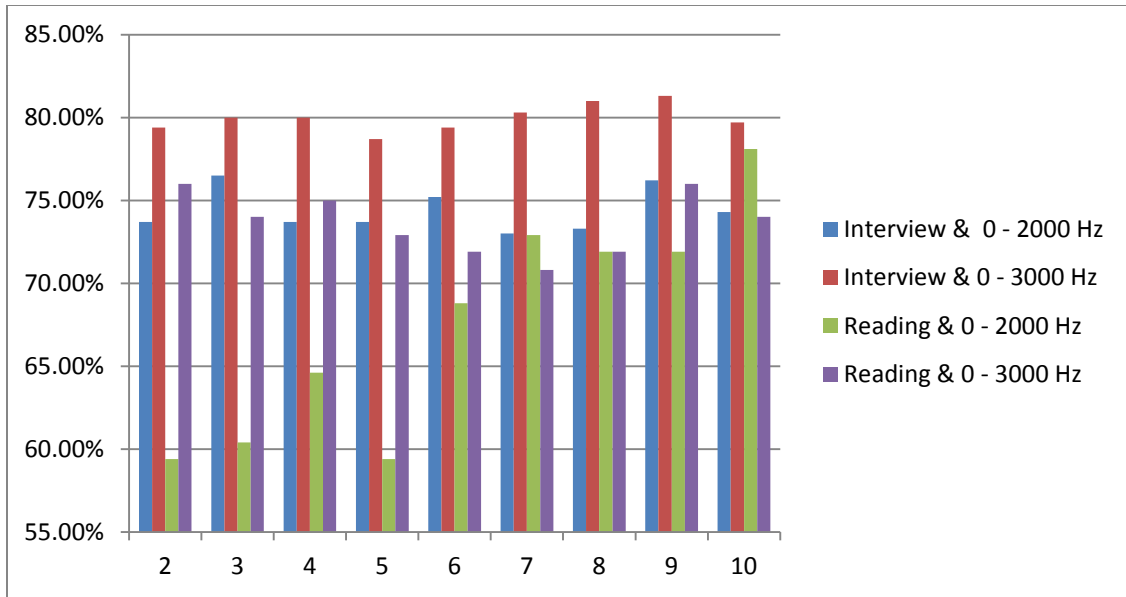

Figure 174: Comparison of Sessions for the Male DP – HR with Quadratic Classification

All of the results about different session comparisons are shown in the Table 58 below for the Depressed – High Risk Suicidal (DP-HR) pairwise group for the male patients with different band ranges (0-2000 Hz and 0-3000 Hz). The highlighted sessions are the sessions that gave good classification results for the specific classification methods.

Table 58: Session Type Comparison Results for the DP – HR Pair of Male Patients with Different Band Ranges

MALE DP - HR PAIR						
	LINEAR		CROSS VALIDATED		QUADRATIC	
Band #	0 - 2000	0 - 3000	0 - 2000	0 - 3000	0 - 2000	0 - 3000
2	Interview	Interview	Interview	Interview	Interview	Interview
3	Interview	Interview	Interview	Interview	Interview	Interview
4	Interview	Interview	Interview	Interview	Interview	Interview
5	Interview	Interview	Interview	Interview	Interview	Interview
6	Interview	Interview	Interview	Interview	Interview	Interview
7	Both Best	Interview	Interview	Interview	Both Best	Interview
8	Both Best	Interview	Interview	Interview	Interview	Interview
9	Interview	Interview	Interview	Interview	Interview	Interview
10	Reading	Interview	Interview	Interview	Reading	Interview

When the interview session and the reading session is compared for the Depressed – Remitted (DP-RM) pairwise group for the male patients using the linear classification, the interview session in the 0-2000 Hz frequency range gave the best result for all results except 3 bands and 10 bands. The classification rate was good for the reading session in the 0-3000 Hz frequency range of 3 bands. For 10 bands, the interview session in the 0-3000 Hz frequency range gave better result. These results can be seen in Figure 175 below.

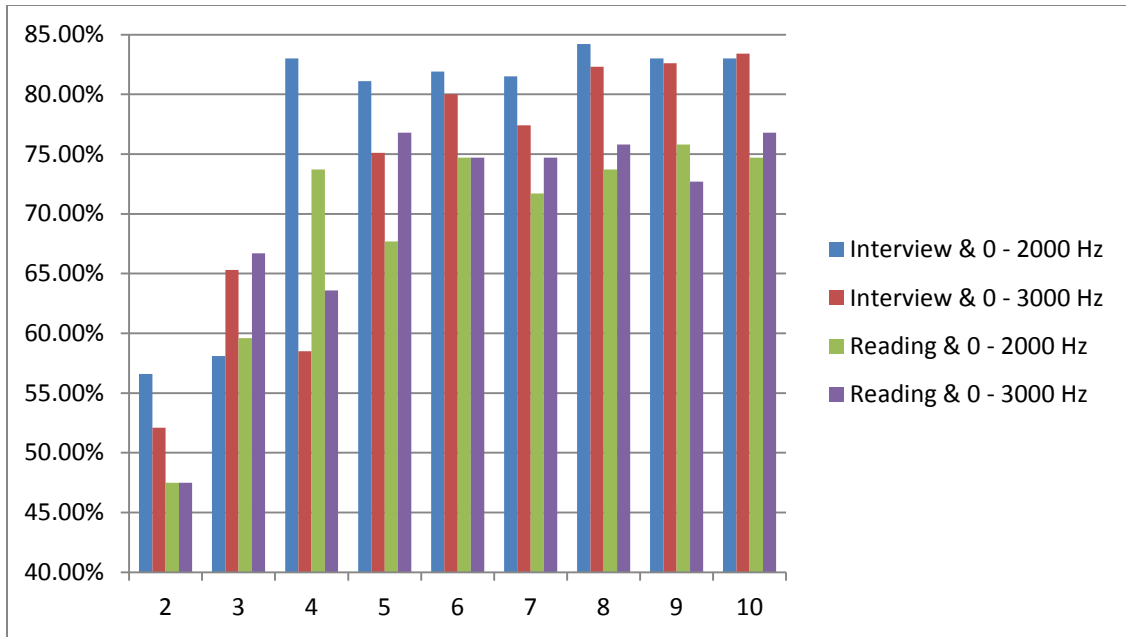

Figure 175: Comparison of Sessions for the Male DP – RM with Linear Classification

For the Depressed – Remitted (DP-RM) pairwise group for the male patients using the cross validated classification; interview session in the 0-2000 Hz frequency range gave the best result for all bands except 3 bands. For 3 bands, both the interview and the reading session in the 0-3000 Hz frequency range gave good results. The interview session in the 0-3000 Hz frequency range also gave good results for 9 bands and 10 bands as well as the interview session in the 0-2000 Hz frequency range. These results can be seen in Figure 176 below.

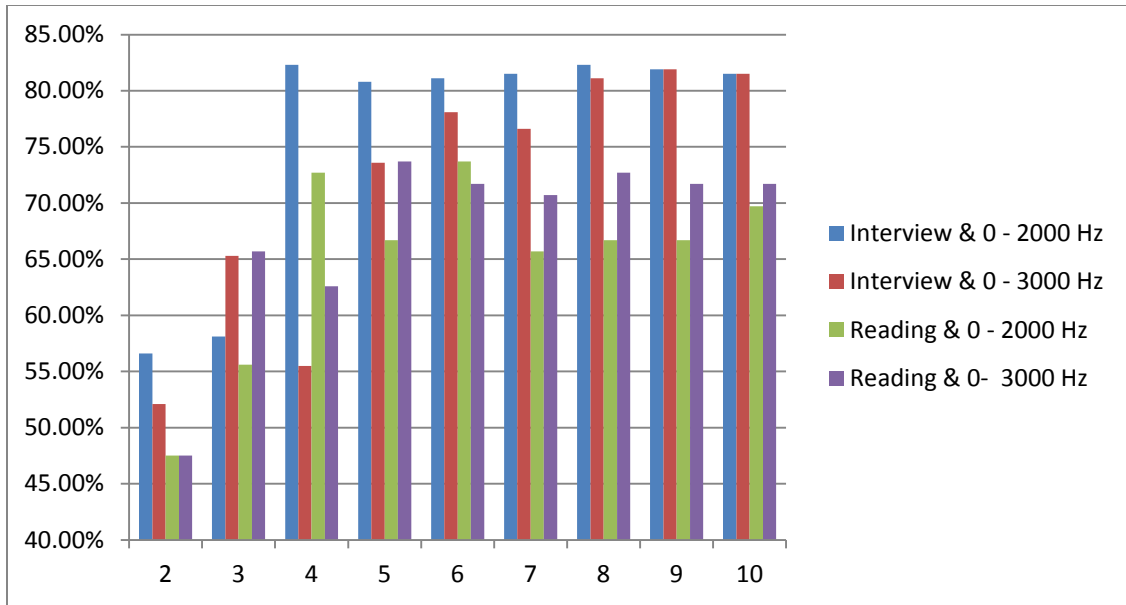

Figure 176: Comparison of Sessions for the Male DP – RM with Cross Validated Classification

For the Depressed – Remitted (DP-RM) pairwise group for the male patients using the quadratic classification, interview session in the 0-2000 Hz frequency range gave the best result for all bands except 3 bands. For this band, the classification rate was better for the reading in the 0-3000 Hz. These results can be seen in Figure 177 below.

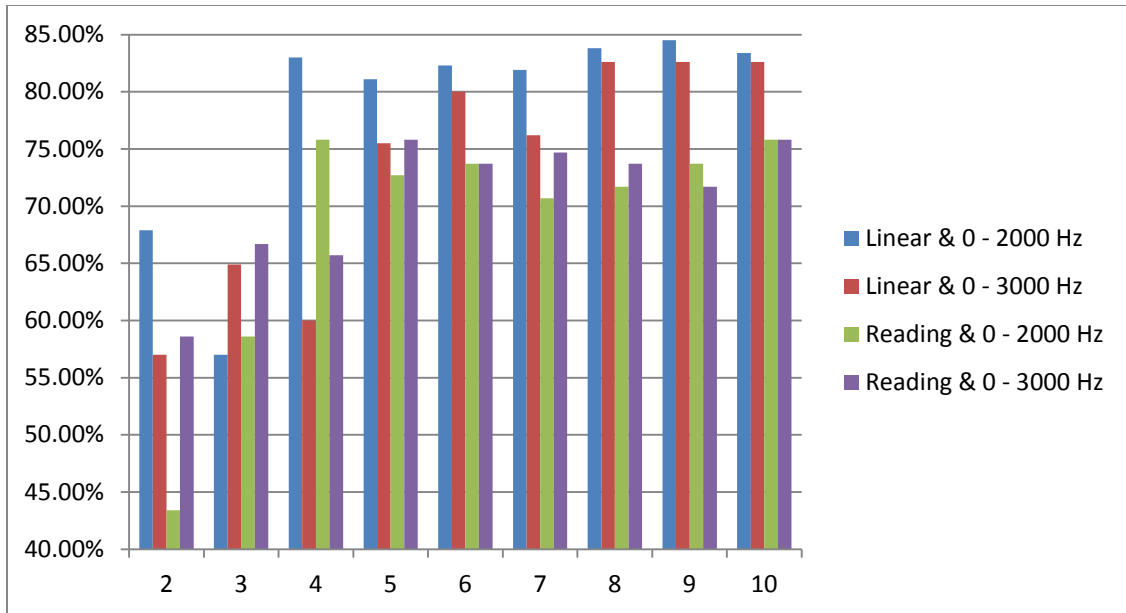

Figure 177: Comparison of Sessions for the Male DP – RM with Quadratic Classification

All of the results about different session comparisons are shown in Table 59 below for the Depressed – Remitted (DP-RM) pairwise group for the male patients with different band ranges (0-2000 Hz and 0-3000 Hz). The highlighted sessions are the sessions that gave good classification results for the specific classification methods.

Table 59: Session Type Comparison Results for the DP – RM Pair of Male Patients with Different Band Ranges

MALE DP - RM PAIR						
Band #	LINEAR		CROSS VALIDATED		QUADRATIC	
	0 - 2000	0 - 3000	0 - 2000	0 - 3000	0 - 2000	0 - 3000
2	Interview	Interview	Interview	Interview	Interview	About same but Reading
3	About same but Reading	Reading	About same but Interview	Both best	About same but Reading	Reading
4	Interview	Reading	Interview	Reading	Interview	Reading
5	Interview	About same but Reading	Interview	Both best	Interview	Both best
6	Interview	Interview	Interview	Interview	Interview	Interview
7	Interview	Interview	Interview	Interview	Interview	About same but Interview
8	Interview	Interview	Interview	Interview	Interview	Interview
9	Interview	Interview	Interview	Interview	Interview	Interview
10	Interview	Interview	Interview	Interview	Interview	Interview

When the interview session and the reading session is compared for the High Risk Suicidal – Remitted (HR-RM) pairwise group for the male patients using the linear classification, interview session in the 0-3000 Hz gave the best result for all bands except 9 bands. The interview session in the 0-2000 Hz gave the best result for 9 bands. These results can be seen in Figure 178 below.

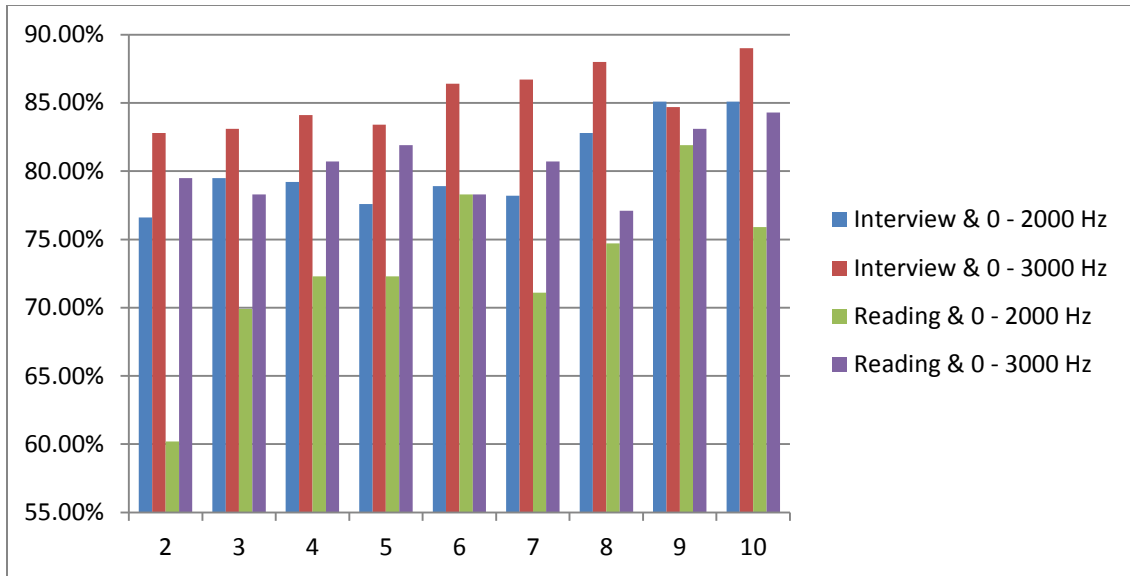

Figure 178: Comparison of Sessions for the Male HR – RM with Linear Classification

For the High Risk Suicidal – Remitted (HR-RM) pairwise group for the male patients using the cross validated classification; interview session in the 0-3000 Hz frequency range gave the best result for all bands. For the 9 bands, the interview session in the 0-2000 Hz frequency range also gave good classification rate. These results can be seen in Figure 179 below.

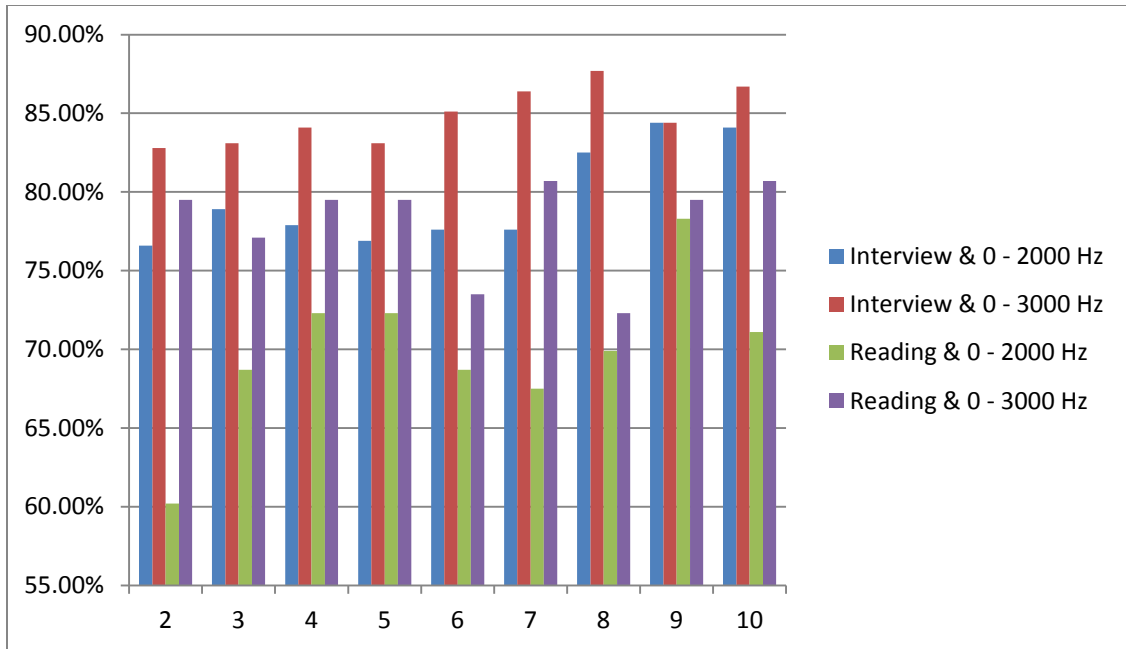

Figure 179: Comparison of Sessions for the Male HR – RM with Cross Validated Classification

For the High Risk Suicidal – Remitted (HR-RM) pairwise group for the male patients using the quadratic classification, interview session in the 0-3000 Hz frequency range gave the best result for all bands. For 9 bands, interview session in the 0-2000 Hz frequency range also gave good classification rate. These results can be seen in Figure 180 below.

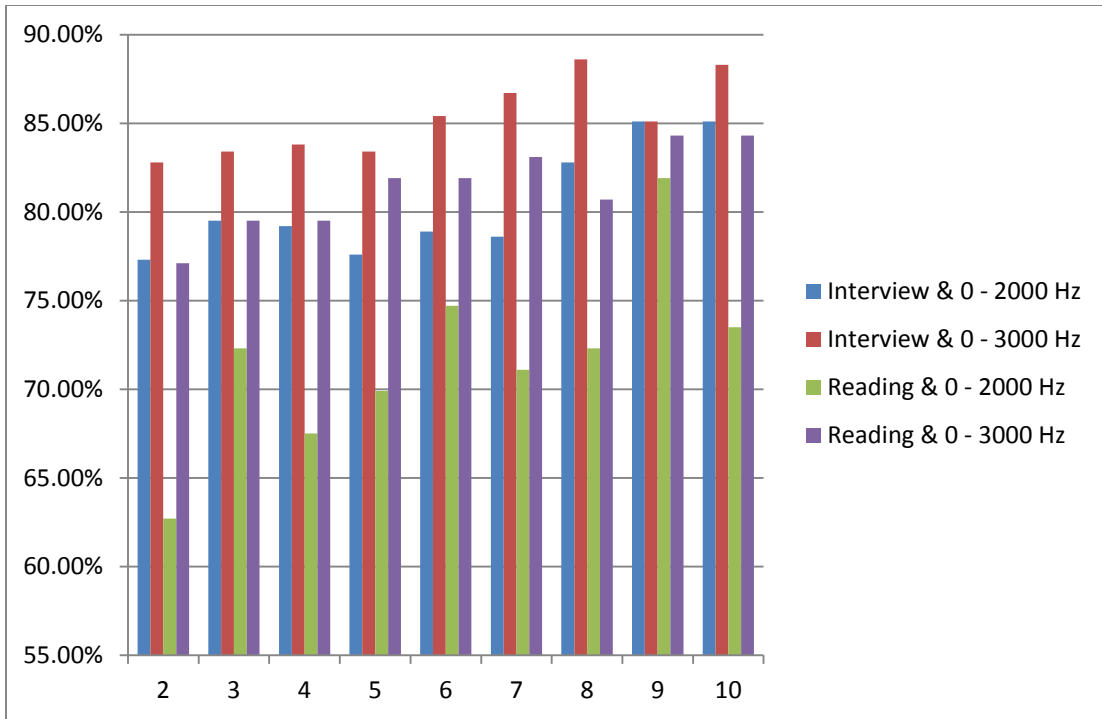

Figure 180: Comparison of Sessions for the Male HR – RM with Quadratic Classification

All of the results about different session comparisons are shown in Table 60 below for the High Risk Suicidal – Remitted (HR-RM) pairwise group for the male patients with different band ranges (0-2000 Hz and 0-3000 Hz). The highlighted sessions are the sessions that gave good classification results for the specific classification methods.

Table 60: Session Type Comparison Results for the HR – RM Pair of Male Patients with Different Band Ranges

MALE HR - RM PAIR						
Band #	LINEAR		CROSS VALIDATED		QUADRATIC	
	0 - 2000	0 - 3000	0 - 2000	0 - 3000	0 - 2000	0 - 3000
2	Interview	Interview	Interview	Interview	Interview	Interview
3	Interview	Interview	Interview	Interview	Interview	Interview
4	Interview	Interview	Interview	Interview	Interview	Interview
5	Interview	Interview	Interview	Interview	Interview	Interview
6	Both best	Interview	Interview	Interview	Interview	Interview
7	Interview	Interview	Interview	Interview	Interview	Interview
8	Interview	Interview	Interview	Interview	Interview	Interview
9	Interview	Interview	Interview	Interview	Interview	Interview
10	Interview	Interview	Interview	Interview	Interview	Interview

3.2.5 Comparison of Pairwise Groups with Different Band Ranges

For this part of the research, three different types of pairwise groups with different band ranges (0-2000 Hz and 0-3000 Hz) are compared. They are the Depressed – High Risk Suicidal (DP-HR), Depressed – Remitted (DP-RM), High Risk Suicidal – Remitted (HR-RM). Depressed patients (DP) are the people who were diagnosed with depression, High Risk Suicidal patients (HR) are the people who were diagnosed with high risk suicide, and Remitted patients (RM) are the people who were diagnosed with remission from the depression. The following part will show the results of different pairwise groups’ comparisons of different band ranges.

3.2.5.1 Female Patents' Pairwise Group Comparisons

When the pairwise groups were compared for the female interview session with using the linear classification with different band ranges, HR-RM pairwise group in the 0-2000 Hz frequency range gave the best classification rates for 3 bands, 4 bands, 6 bands, and 10 bands. DP- HR pairwise group in the 0-2000 Hz frequency range gave the best classification rates for 7 bands, 8 bands and 9 bands. DP-RM pairwise group in the 0-2000 Hz frequency range gave the best classification rate for 2 bands. Finally, HR-RM pairwise group in the 0-3000 Hz frequency range gave the best classification rates for 5 bands. These results can be seen in Figure 181 below.

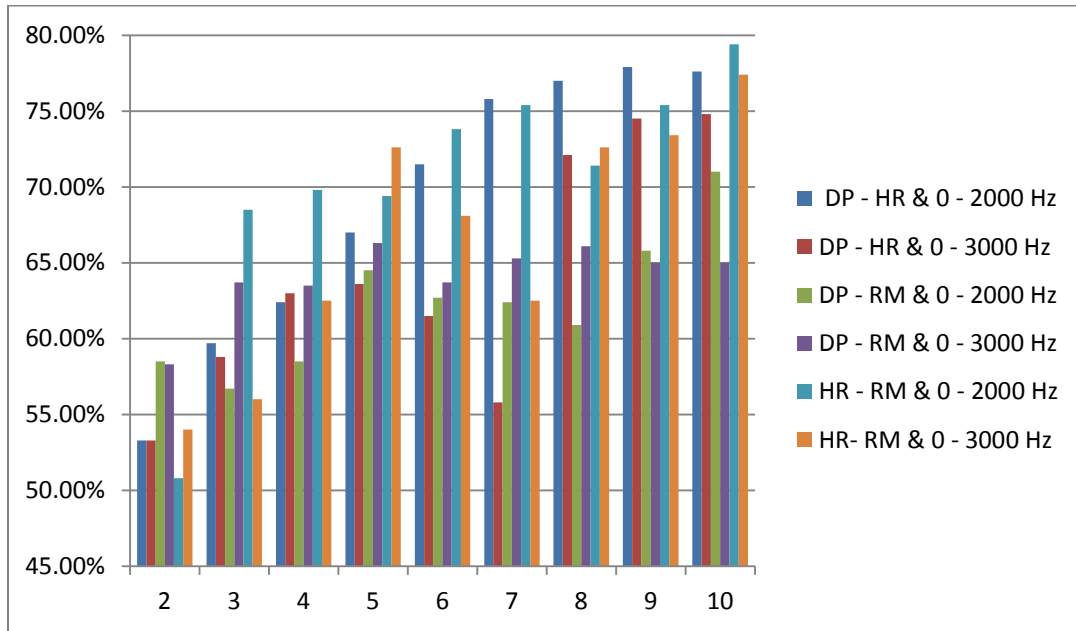

Figure 181: Comparison of Pairs for the Female Patients in Interview Session with Linear Classification

When the pairwise groups were compared for the female interview session with using the cross validated classification, DP- HR pairwise group in the 0-2000 Hz frequency range gave the best classification rates for 7 bands, 8 bands, 9 bands and 10 bands. HR-RM pairwise group in the 0-2000 Hz frequency range gave the best classification rates for 3 bands, 4 bands, and 6 bands. DP-RM pairwise group in the 0-2000 Hz frequency range gave the best classification rate for 2 bands. Finally, HR-RM pairwise group in the 0-3000 Hz frequency range gave the best classification rates for 5 bands. These results can be seen in Figure 182 below.

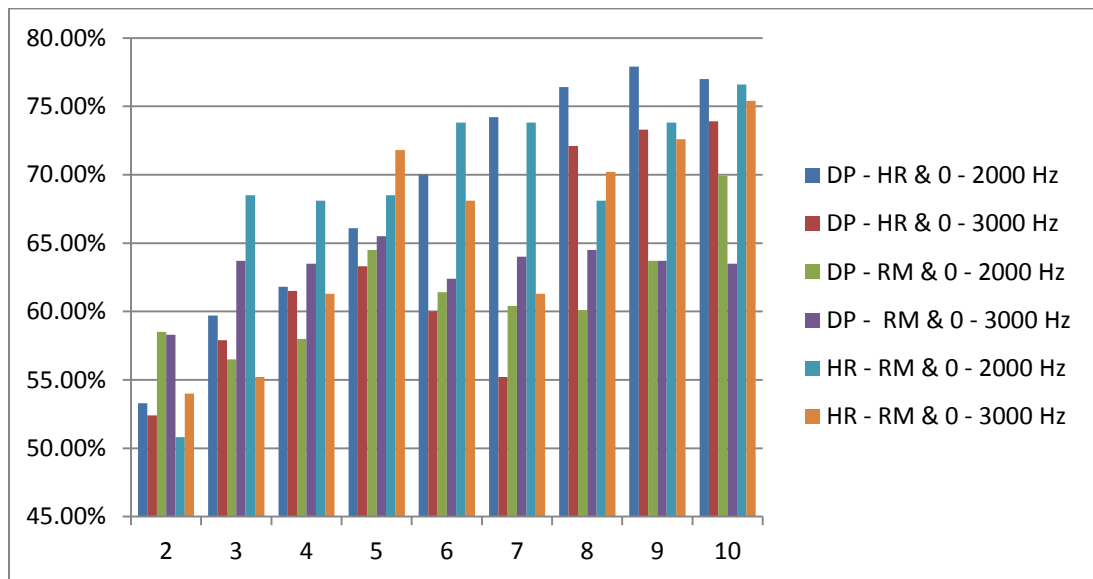

Figure 182: Comparison of Pairs for the Female Patients in Interview Session with Cross Validated Classification

When the pairwise groups were compared for the female interview session with using the quadratic classification, the HR-RM pairwise group in the 0-2000 Hz frequency range

gave the best classification rates for the lower number of bands (2 bands, 3 bands, 4 bands). HR-RM pairwise group in the 0-3000 Hz frequency range gave the best classification rates for 5 bands. DP- HR pairwise group gave the best classification rates for higher number of bands (6 bands, 7 bands, 8 bands, 9 bands and 10 bands). These results can be seen in Figure 183 below.

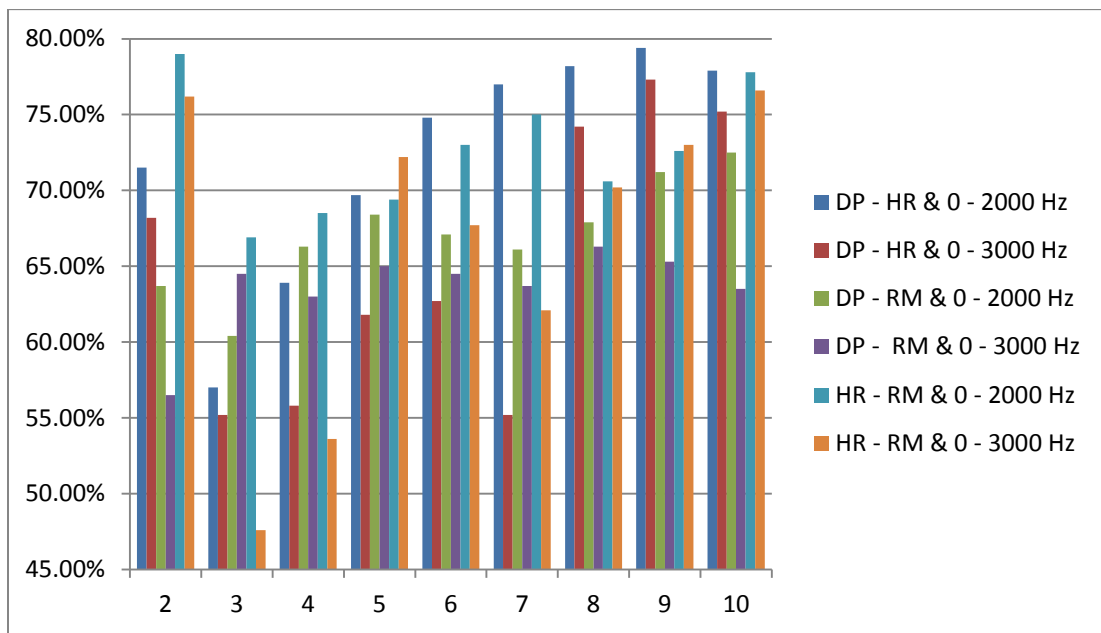

Figure 183: Comparison of Pairs for the Female Patients in Interview Session with Quadratic Classification

All of the results about different pairwise groups' comparisons are shown in Table 61 below for the female interview session with different band ranges (0-2000 Hz and 0-3000 Hz). The highlighted sessions are the sessions that gave good classification results for the specific classification methods.

Table 61: Pair Comparison Results for the Female Patients in Interview Session with Different Band Ranges

FEMALE INTERVIEW						
Band #	LINEAR		CROSS VALIDATED		QUADRATIC	
	0 - 2000	0 - 3000	0 - 2000	0 - 3000	0 - 2000	0 - 3000
2	DP - RM	DP - RM	DP - RM	DP - RM	HR - RM	HR - RM
3	HR - RM	DP - RM	HR - RM	DP - RM	HR - RM	DP - RM
4	HR - RM	DP - RM	HR - RM	DP - RM	HR - RM	DP - RM
5	HR - RM	HR - RM	HR - RM	HR - RM	DP - HR	HR - RM
6	HR - RM	HR - RM	HR - RM	HR - RM	DP - HR	HR - RM
7	DP - HR	DP - RM	DP - HR	DP - RM	DP - HR	DP - HR
8	DP - HR	HR - RM	DP - HR	DP - HR	DP - HR	DP - HR
9	DP - HR	DP - HR	DP - HR	DP - HR	DP - HR	DP - HR
10	HR - RM	HR - RM	DP - HR	HR - RM	DP - HR	HR - RM

When the pairwise groups were compared for the female reading session with using the linear classification, HR-RM pairwise group in the 0-2000 Hz frequency range gave the best classification rates for 3 bands, 4 bands, 7 bands, 8 bands and 10 bands. DP- RM pairwise group in the 0-2000 Hz frequency range gave the best classification rates for 6 bands. Both the DP- RM pairwise group in the 0-2000 Hz frequency range and the DP- RM pairwise group in the 0-3000 Hz frequency range gave the best classification rates for 2 bands. HR-RM pairwise group in the 0-3000 Hz frequency range gave the best classification rates for all 5 bands and 9 bands. These results can be seen in Figure 184 below.

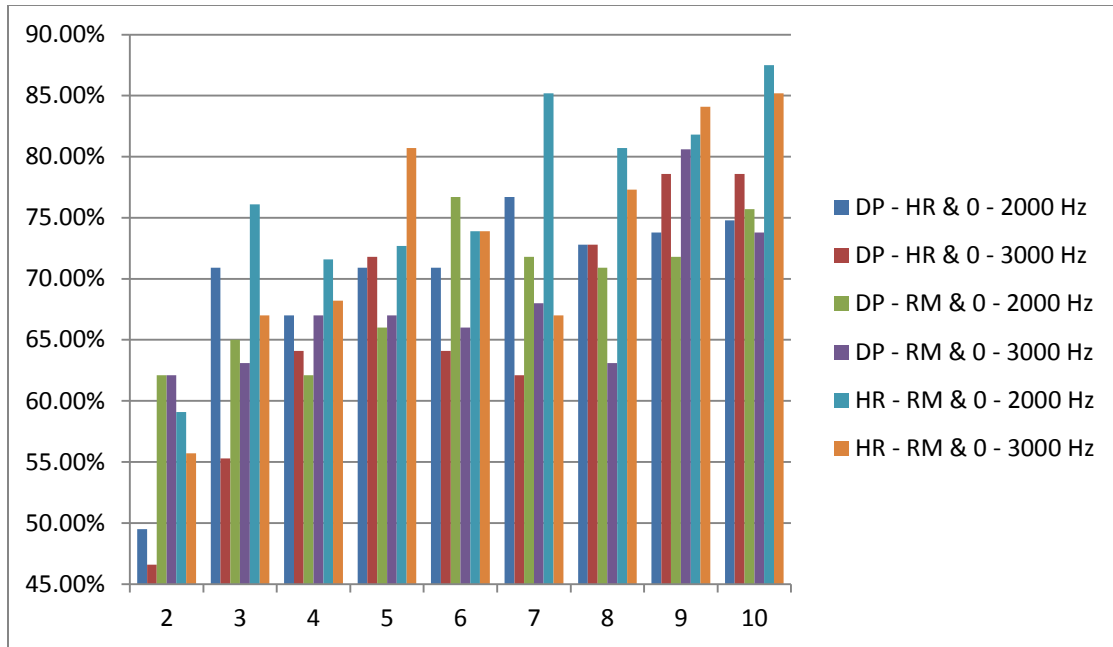

Figure 184: Comparison of Pairs for the Female Patients in Reading Session with Linear Classification

When the pairwise groups were compared for the female reading session with using the cross validated classification, HR-RM pairwise group in the 0-2000 Hz frequency range gave the best classification rates for 3 bands, 4 bands, 7 bands and 8 bands. HR-RM pairwise group in the 0-3000 Hz frequency range gave the best classification rates for 5 bands and 10 bands. DP-RM pairwise group in the 0-2000 Hz gave the best classification rate for 2 bands and 6 bands. DP-RM pairwise group in the 0-3000 Hz gave the best classification rate for 9 bands. These results can be seen in Figure 185 below.

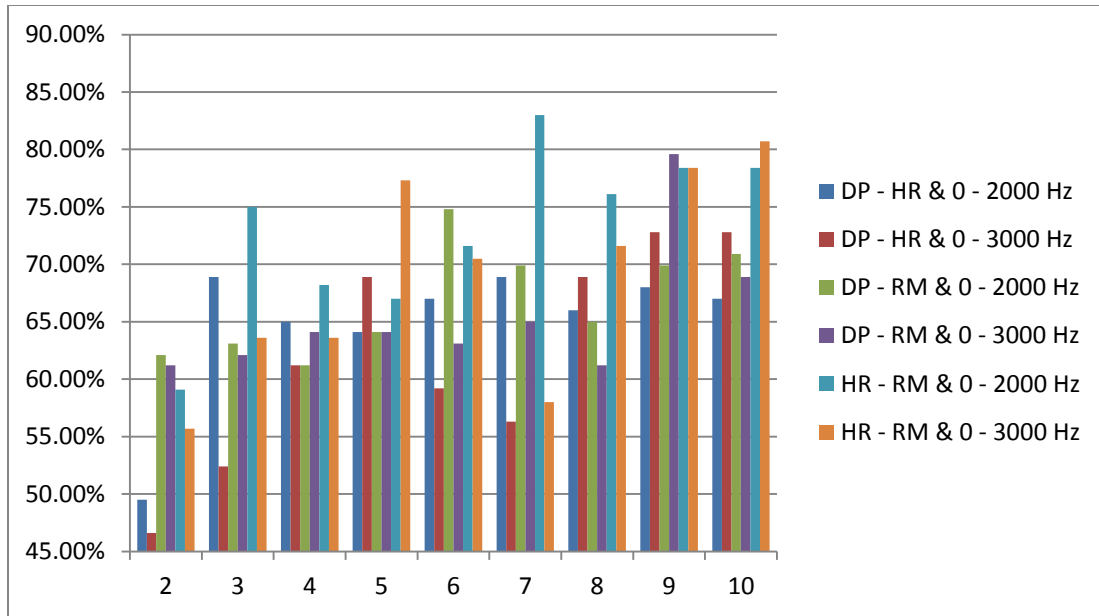

Figure 185: Comparison of Pairs for the Female Patients in Reading Session with Cross Validated Classification

When the pairwise groups were compared for the female reading session with using the quadratic classification, HR-RM pairwise group in the 0-2000 Hz frequency range gave the best classification rates for 3 bands, 7 bands, 8 bands, and 10 bands. DP-RM pairwise group in the 0-2000 Hz frequency band range gave the best classification rate for 6 bands. HR-RM pairwise group in the 0-3000 Hz frequency range gave the best classification rates for 2 bands, 5 bands, and 9 bands. Both the HR-RM pairwise group in the 0-2000 Hz frequency range and the HR-RM pairwise group in the 0-3000 Hz frequency range gave the best classification rate for 4 bands. These results can be seen in Figure 186 below.

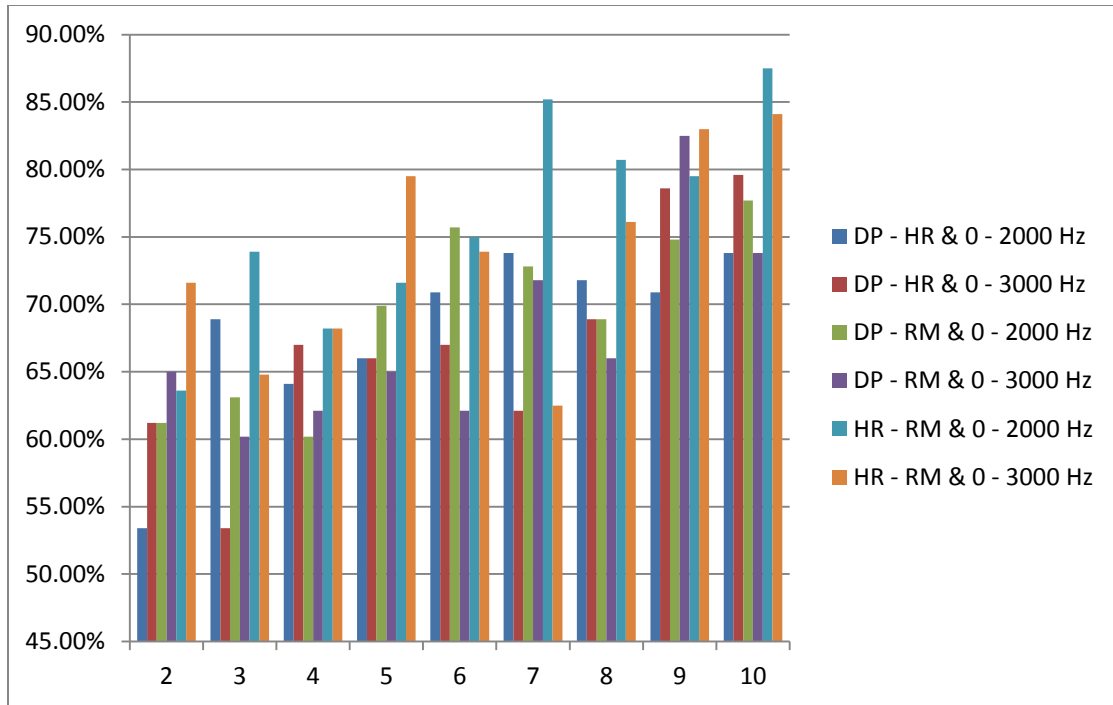

Figure 186: Comparison of Pairs for the Female Patients in Reading Session with Quadratic Classification

All of the results about different pairwise groups' comparisons are shown in Table 62 below for the female reading session with different band ranges (0-2000 Hz and 0-3000 Hz). The highlighted sessions are the sessions that gave good classification results for the specific classification methods.

Table 62: Pair Comparison Results for the Female Patients in Reading Session with Different Band Ranges

FEMALE READING						
	LINEAR		CROSS VALIDATED		QUADRATIC	
Band #	0 - 2000	0 - 3000	0 - 2000	0 - 3000	0 - 2000	0 - 3000
2	DP - RM	DP - RM	DP - RM	DP - RM	HR - RM	HR - RM
3	HR - RM	HR - RM	HR - RM	HR - RM	HR - RM	HR - RM
4	HR - RM	HR - RM	HR - RM	DP - RM	HR - RM	HR - RM
5	HR - RM	HR - RM	HR - RM	HR - RM	HR - RM	HR - RM
6	DP - RM	HR - RM	DP - RM	HR - RM	DP - RM	HR - RM
7	HR - RM	DP - RM	HR - RM	DP - RM	HR - RM	DP - RM
8	HR - RM	HR - RM	HR - RM	HR - RM	HR - RM	HR - RM
9	HR - RM	HR - RM	HR - RM	DP - RM	HR - RM	HR - RM
10	HR - RM	HR - RM	HR - RM	HR - RM	HR - RM	HR - RM

3.2.5.2 Male Patients' Pairwise Group Comparisons

When the pairwise groups were compared for the male interview session with using the linear classification, the HR-RM pairwise group in the 0-3000 Hz frequency range gave the best classification rates for all bands except 9 bands. HR-RM pairwise group in the 0-2000 Hz frequency range gave the best classification rates for 9 bands. These results can be seen in Figure 187 below.

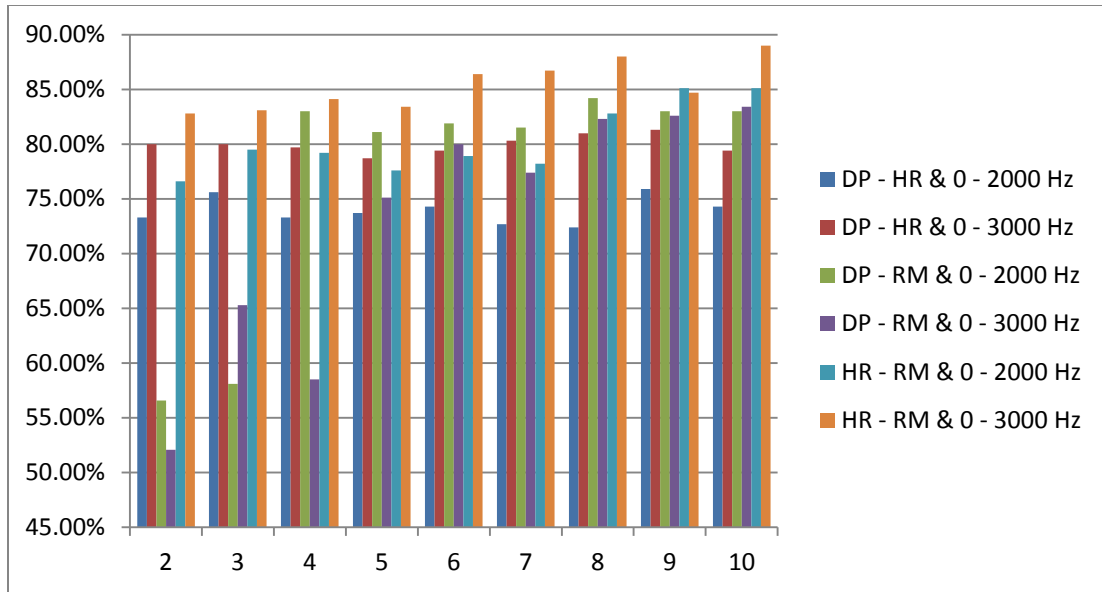

Figure 187: Comparison of Pairs for the Male Patients in Interview Session with Linear Classification

When the pairwise groups were compared for the male interview session with using the cross validated classification, the HR-RM pairwise group in the 0-3000 Hz frequency range gave the best classification rates for all bands except 9 bands. Both the HR-RM pairwise group in the 0-2000 Hz frequency range and the HR-RM pairwise group in the 0-3000 Hz frequency range gave good result for 9 bands. These results can be seen in Figure 188 below.

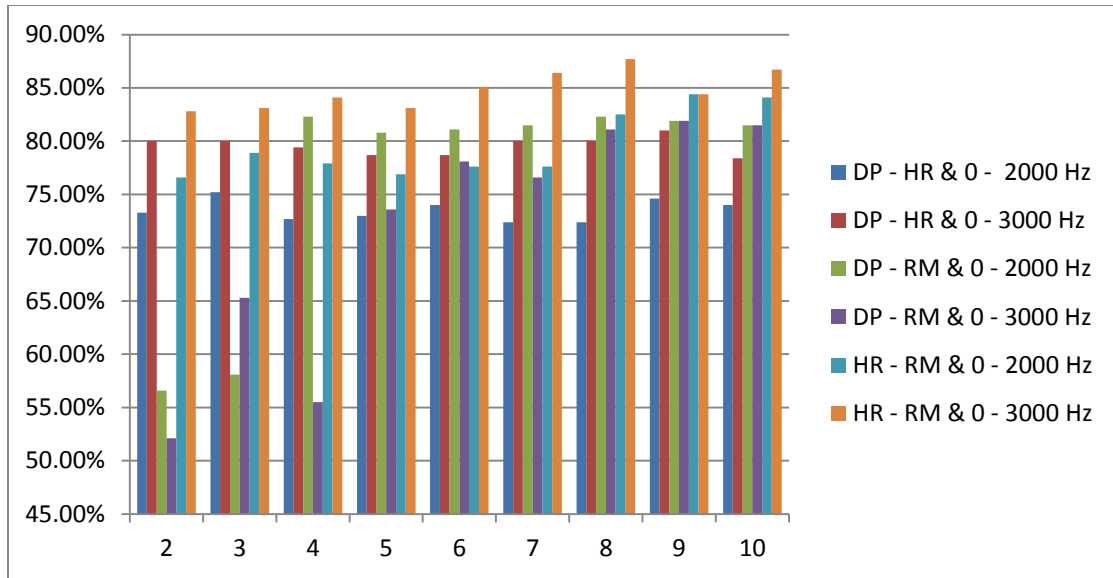

Figure 188: Comparison of Pairs for the Male Patients in Interview Session with Cross Validated Classification

When the pairwise groups were compared for the male interview session with using the quadratic classification, the HR-RM pairwise group in the 0-3000 Hz frequency range gave the best classification rates for all bands except 9 bands. Both the HR-RM pairwise group in the 0-2000 Hz frequency range and the HR-RM pairwise group in the 0-3000 Hz frequency range gave good result for 9 bands. These results can be seen in Figure 189 below.

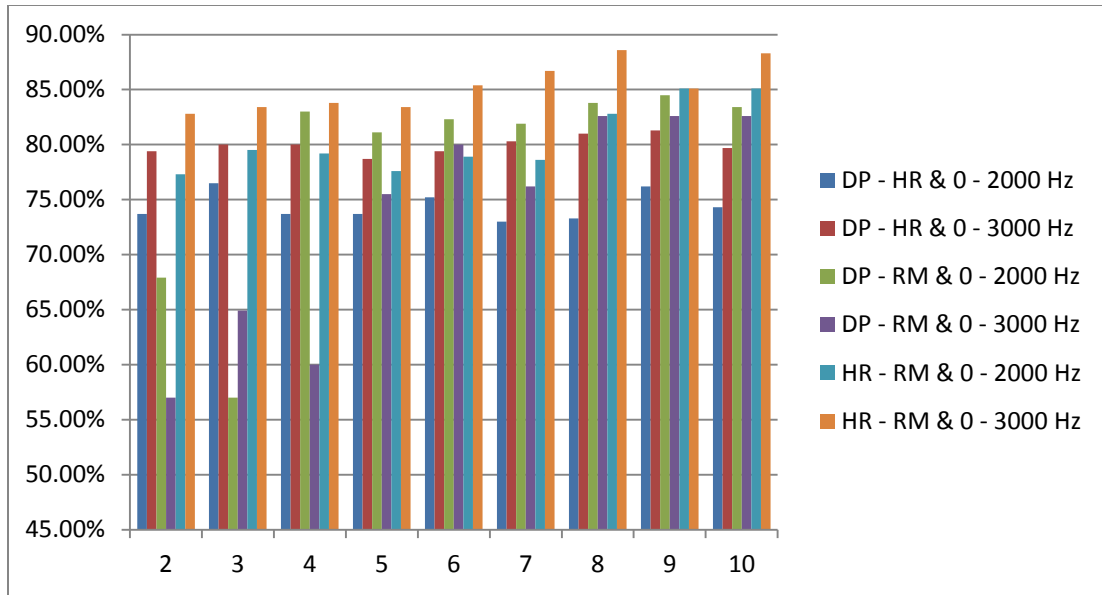

Figure 189: Comparison of Pairs for the Male Patients in Interview Session with Quadratic Classification

All of the results about different pairwise groups' comparisons are shown in Table 63 below for the male interview session with different band ranges (0-2000 Hz and 0-3000 Hz). The highlighted sessions are the sessions that gave good classification results for the specific classification methods.

Table 63: Pair Comparison Results for the Male Patients in Interview Session with Different Band Ranges

MALE INTERVIEW						
Band #	LINEAR		CROSS VALIDATED		QUADRATIC	
	0 - 2000	0 - 3000	0 - 2000	0 - 3000	0 - 2000	0 - 3000
2	HR - RM	HR - RM	HR - RM	HR - RM	HR - RM	HR - RM
3	HR - RM	HR - RM	HR - RM	HR - RM	HR - RM	HR - RM
4	DP - RM	HR - RM	DP - RM	HR - RM	DP - RM	HR - RM
5	DP - RM	HR - RM	DP - RM	HR - RM	DP - RM	HR - RM
6	DP - RM	HR - RM	DP - RM	HR - RM	DP - RM	HR - RM
7	DP - RM	HR - RM	DP - RM	HR - RM	DP - RM	HR - RM
8	DP - RM	HR - RM	HR - RM	HR - RM	DP - RM	HR - RM
9	HR - RM	HR - RM	HR - RM	HR - RM	HR - RM	HR - RM
10	HR - RM	HR - RM	HR - RM	HR - RM	HR - RM	HR - RM

When the pairwise groups were compared for the male reading session with using the linear classification, the HR-RM pairwise group in the 0-3000 Hz frequency range gave the best classification rates for all bands. Additionally, HR-RM pairwise group in the 0-2000 Hz frequency range also gave the same best result like HR-RM pairwise group in the 0-3000 Hz frequency range for 6 bands. These results can be seen in Figure 190 below.

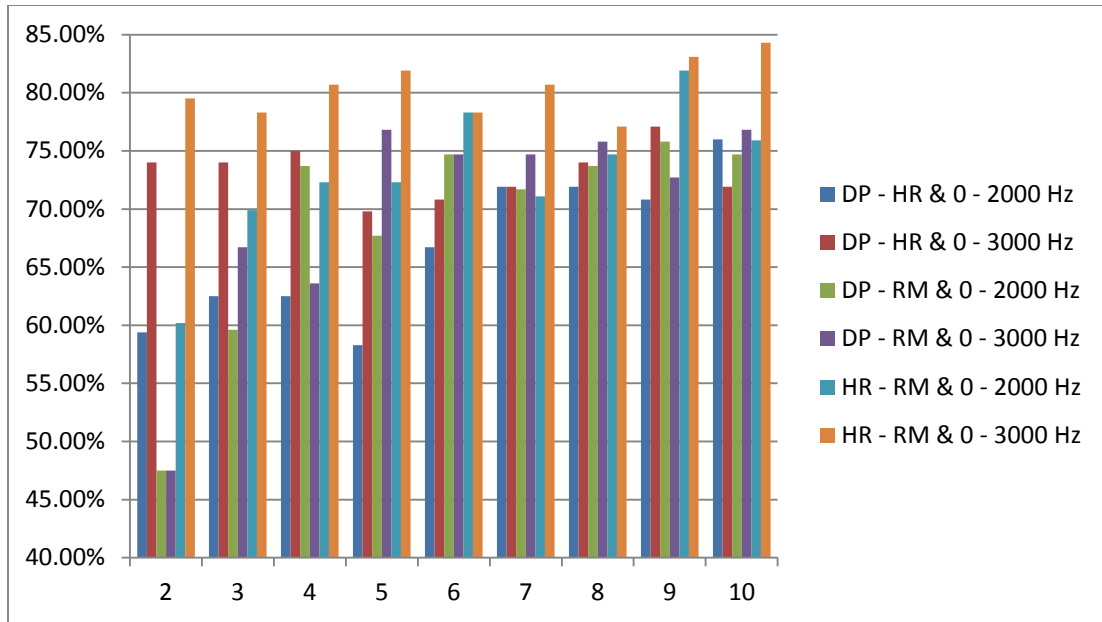

Figure 190: Comparison of Pairs for the Male Patients in Reading Session with Linear Classification

When the pairwise groups were compared for the male reading session with using the cross validated classification, the HR-RM pairwise group in the 0-3000 Hz frequency range gave the best classification rates for all bands except 6 bands and 8 bands. DP-RM pairwise group in the 0-2000 Hz frequency range gave the best classification rate for 6 bands. DP-RM pairwise group in the 0-3000 Hz frequency range gave the best classification rate for 8 bands. These results can be seen in Figure 191 below.

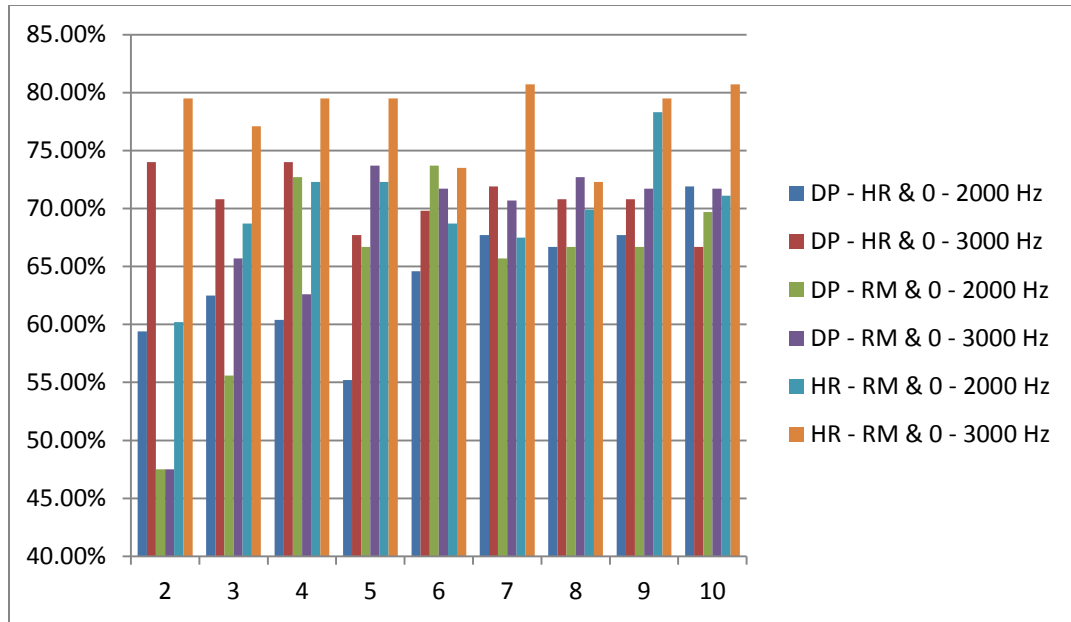

Figure 191: Comparison of Pairs for the Male Patients in Reading Session with Cross Validated Classification

When the pairwise groups were compared for the male reading session with using the quadratic classification, the HR-RM pairwise group in the 0-3000 Hz frequency range gave the best classification rates for all bands. These results can be seen in Figure 192 below.

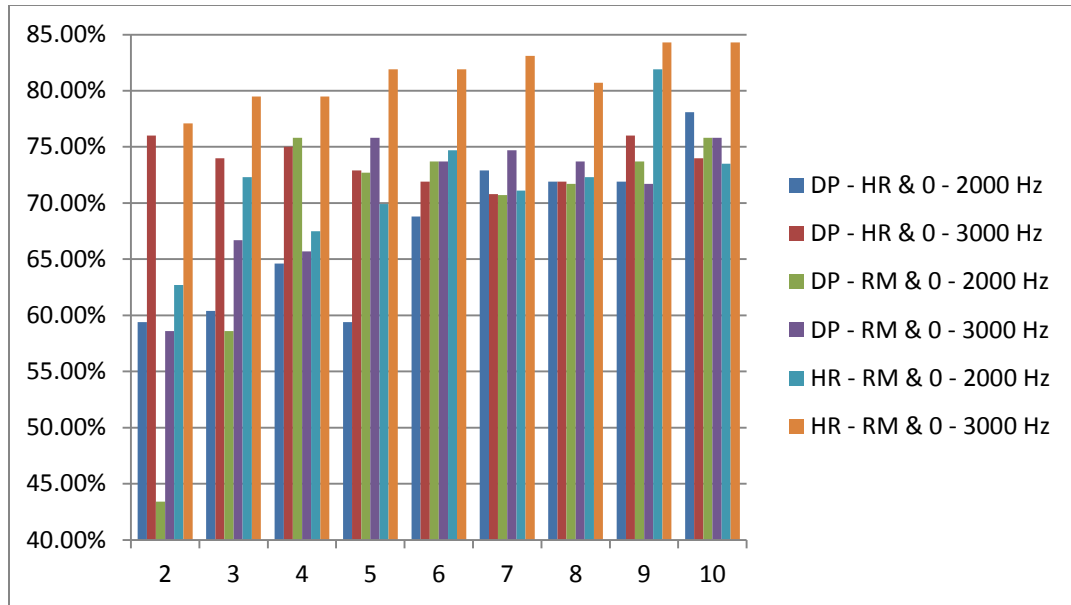

Figure 192: Comparison of Pairs for the Male Reading with Quadratic Classification

All of the results about different pairwise groups' comparisons are shown in Table 64 below for the male reading session with different band ranges (0-2000 Hz and 0-3000 Hz). The highlighted sessions are the sessions that gave good classification results for the specific classification methods.

Table 64: Pair Comparison Results for the Male Patients in Reading Session with Different Band Ranges

MALE READING						
Band #	LINEAR		CROSS VALIDATED		QUADRATIC	
	0 - 2000	0 - 3000	0 - 2000	0 - 3000	0 - 2000	0 - 3000
2	HR - RM	HR - RM	HR - RM	HR - RM	HR - RM	HR - RM
3	HR - RM	HR - RM	HR - RM	HR - RM	HR - RM	HR - RM
4	DP - RM	HR - RM	DP - RM	HR - RM	DP - RM	HR - RM
5	HR - RM	HR - RM	HR - RM	HR - RM	DP - RM	HR - RM
6	HR - RM	HR - RM	DP - RM	HR - RM	HR - RM	HR - RM
7	DP - HR	HR - RM	DP - HR	HR - RM	DP - HR	HR - RM
8	HR - RM	HR - RM	HR - RM	DP - RM	HR - RM	HR - RM
9	HR - RM	HR - RM	HR - RM	HR - RM	HR - RM	HR - RM
10	DP - HR	HR - RM	DP - HR	HR - RM	DP - HR	HR - RM

3.3 Optimization with Different Energy Band Edges

In this research, the optimization with different band edges was analyzed for finding the optimized energy bands. Exponential band edges and non-uniform band edges are two methods that were used for applying the optimization with different band edges.

3.3.1 Exponential Band Edges

For the exponential band edges study, the edges of energy bands were selected so that the edges grow exponentially. For this study, the original number of bands which is 4 bands was used. Four exponential energy bands in the 0 – 2000 Hz frequency range were analyzed. The sub-band ranges for the exponential energy bands are 0-250 Hz, 250-500 Hz, 500-1000 Hz, and 1000-2000 Hz. Later, four exponential energy bands in the 0 – 3000 Hz frequency range were analyzed. The sub-band ranges for the exponential energy bands are 0-375 Hz, 375-750 Hz, 750-1500 Hz, and 1500-3000 Hz.

3.3.1.1 Exponential Band Edges Study in 0 – 2000 Hz Band Range

In this part of the research, four exponential energy bands in the 0 – 2000 Hz frequency range were analyzed. The exponential edges for the exponential energy band study are 0-250 Hz, 250-500 Hz, 500-1000 Hz, and 1000-2000 Hz. The results were analyzed for the female patients and male patients during the interview session and the reading session and they are shown below.

3.3.1.1.1 Female Patients

3.3.1.1.1.1 Female DP – HR Pairwise Group

In this part of the research, four exponential energy bands in the 0 – 2000 Hz frequency range were analyzed for the Depressed – High Risk Suicidal (DP-HR) pairwise group for the female patients during the interview session were studied. According to the linear classification, the exponential energy bands gave classification rate of 72.70%; regular energy bands gave classification rate of 62.40%. According to the cross validated classification, the exponential energy bands gave classification rate of 72.70%; regular energy bands gave classification rate of 61.80%. According to the quadratic classification, the exponential energy bands gave classification rate of 72.70%; regular energy bands gave classification rate of 63.90%. For all three classifiers, exponential energy bands gave better classification rates than the regular energy bands. Figure 193 shows the classification results for the female DP-HR interview session in the 0-2000 Hz frequency range.

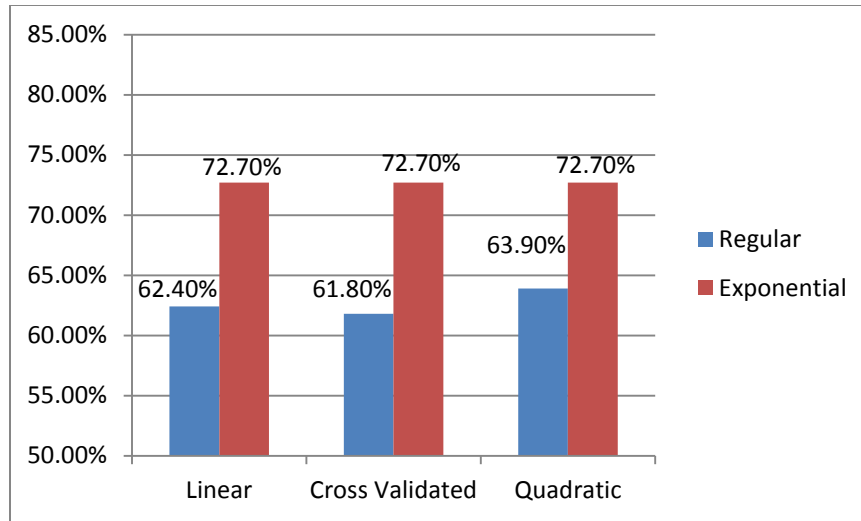

Figure 193: Comparison of Exponential Band Edges and Regular Band Edges for the Female DP- HR Interview (0-2000 Hz)

For the female DP-HR reading session in the 0-2000 Hz frequency range, the exponential energy bands gave classification rate of 71.80%; regular energy bands gave classification rate of 67.00% using the linear classification. According to the cross validated classification, the exponential energy bands gave classification rate of 68.90%; regular energy bands gave classification rate of 65.00%. According to the quadratic classification, the exponential energy bands gave classification rate of 68.90%; regular energy bands gave classification rate of 64.10%. For all three classifiers, exponential energy bands gave better classification rates than the regular energy bands. Figure 194 shows the classification results for the female DP-HR reading session in the 0-2000 Hz frequency range.

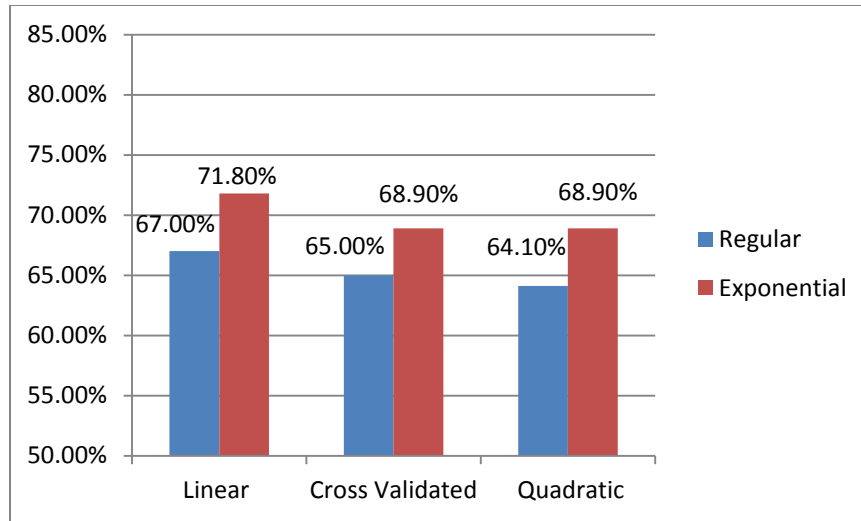

Figure 194: Comparison of Exponential Band Edges and Regular Band Edges for the Female DP- HR Reading (0-2000 Hz)

3.3.1.1.1.2 Female DP – RM Pairwise Group

For the female Depressed – Remitted (DP-RM) interview session in the 0-2000 Hz frequency range, the exponential energy bands gave classification rate of 60.90%; regular energy bands gave classification rate of 58.50% using the linear classification. According to the cross validated classification, the exponential energy bands gave classification rate of 59.10%; regular energy bands gave classification rate of 58.00%. For the linear and the cross validated classifiers, exponential energy bands gave slightly better classification rates than the regular energy bands. According to the quadratic classification, the exponential energy bands gave classification rate of 65.30%; regular energy bands gave classification rate of 66.30%. For the quadratic classifier, the regular energy bands gave slightly better results than the exponential energy bands. Figure 195 shows the classification results for the female DP-RM interview session in the 0-2000 Hz frequency range.

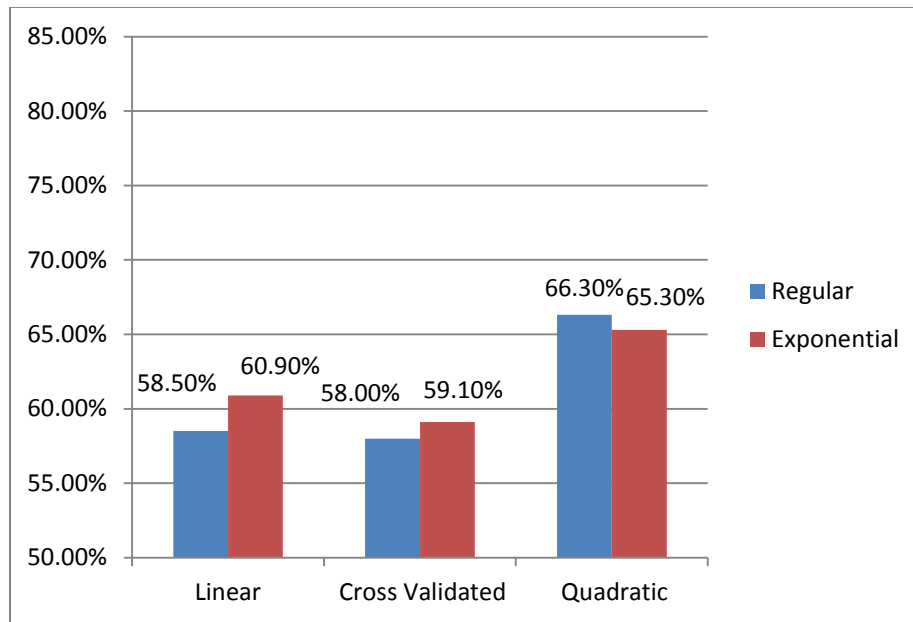

Figure 195: Comparison of Exponential Band Edges and Regular Band Edges for the Female DP- RM Interview (0-2000 Hz)

For the female Depressed – Remitted (DP-RM) reading session in the 0-2000 Hz frequency range, the exponential energy bands gave classification rate of 62.10%; regular energy bands gave classification rate of 62.10% using the linear classification. With linear classifier, both the exponential and the regular energy bands gave exactly the same classification rates. According to the cross validated classification, the exponential energy bands gave classification rate of 58.30%; regular energy bands gave classification rate of 61.20%. For the cross validated classifier, the regular energy bands gave better results than the exponential energy bands. According to the quadratic classification, the exponential energy bands gave classification rate of 63.10%; regular energy bands gave classification rate of 60.20%. For the quadratic classifier, exponential energy bands gave better classification rates than the regular energy bands. Figure 196 shows the

classification results for the female DP-RM reading session in the 0-2000 Hz frequency range.

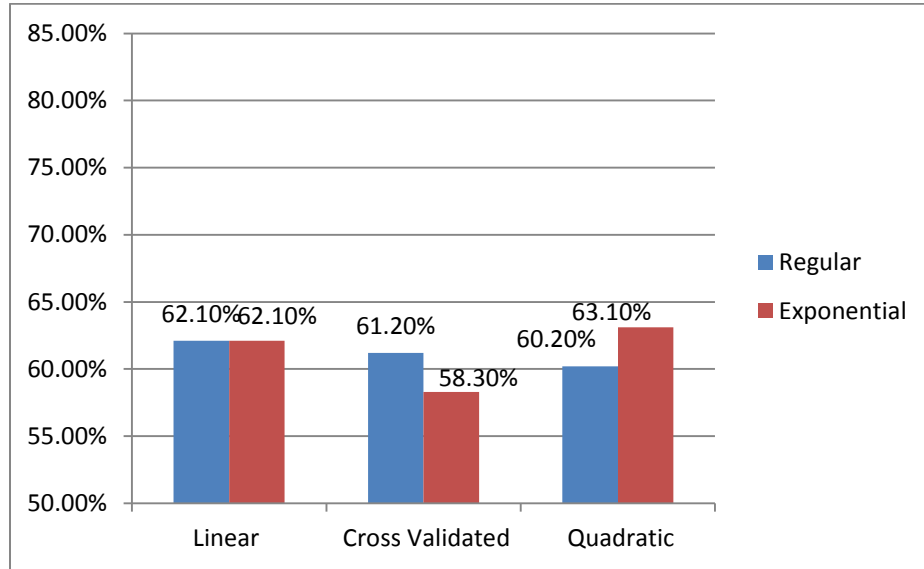

Figure 196: Comparison of Exponential Band Edges and Regular Band Edges for the Female DP- RM Reading (0-2000 Hz)

3.3.1.1.1.3 Female HR – RM Pairwise Group

For the female High Risk Suicidal – Remitted (HR-RM) interview session in the 0-2000 Hz frequency range, the exponential energy bands gave classification rate of 70.20%; regular energy bands gave classification rate of 69.80% using the linear classification. According to the cross validated classification, the exponential energy bands gave classification rate of 69.40%; regular energy bands gave classification rate of 68.10%. For the linear and cross validated classifiers, exponential energy bands gave slightly better classification rates than the regular energy bands. According to the quadratic classification, the exponential energy bands gave classification rate of 68.10%; regular energy bands gave classification rate of 68.50%. For the quadratic classifier, the

regular energy bands gave slightly better results than the exponential energy bands. Figure 197 shows the classification results for the female HR-RM interview session in the 0-2000 Hz frequency range.

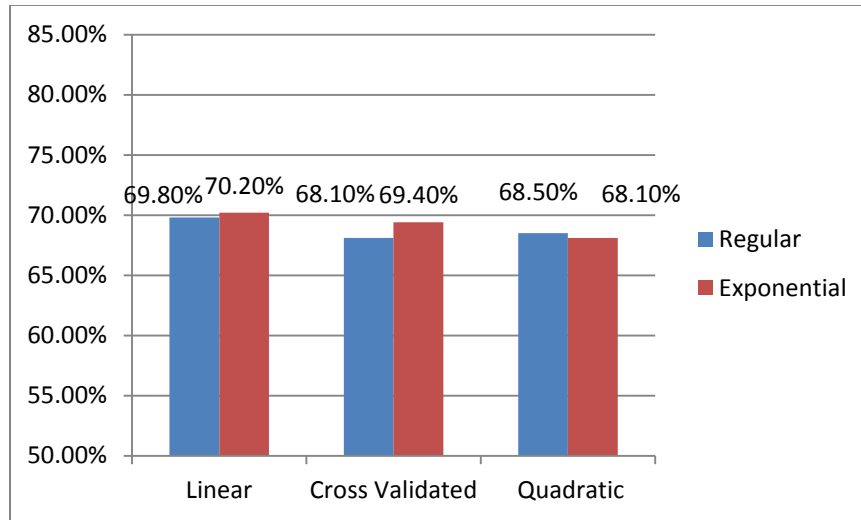

Figure 197: Comparison of Exponential Band Edges and Regular Band Edges for the Female HR- RM Interview (0-2000 Hz)

For the female HR-RM reading session in the 0-2000 Hz frequency range, the exponential energy bands gave classification rate of 75.00%; regular energy bands gave classification rate of 71.60% using the linear classification. According to the cross validated classification, the exponential energy bands gave classification rate of 71.60%; regular energy bands gave classification rate of 68.20%. According to the quadratic classification, the exponential energy bands gave classification rate of 75.00%; regular energy bands gave classification rate of 68.20%. For all three classifiers, the exponential energy bands gave better classification rates than the regular energy bands. Figure 198

shows the classification results for the female HR-RM reading session in the 0-2000 Hz frequency range.

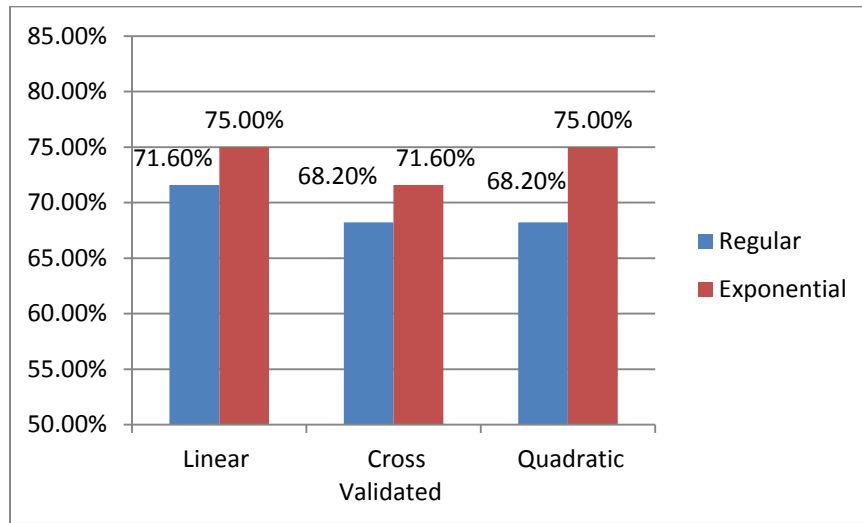

Figure 198: Comparison of Exponential Band Edges and Regular Band Edges for the Female HR- RM Reading (0-2000 Hz)

3.3.1.1.2 Male Patients

3.3.1.1.2.1 Male DP – HR Pairwise Group

Four exponential energy bands in the 0 – 2000 Hz frequency range were analyzed for the Depressed – High Risk Suicidal (DP-HR) pairwise group for the male patients during the interview session were studied. According to the linear classification, the exponential energy bands gave classification rate of 74.00%; regular energy bands gave classification rate of 73.30%. According to the cross validated classification, the exponential energy bands gave classification rate of 73.70%; regular energy bands gave classification rate of 72.70%. According to the quadratic classification, the exponential

energy bands gave classification rate of 74.00%; regular energy bands gave classification rate of 73.70%. For all three classifiers, exponential energy bands gave slightly better classification rates than the regular energy bands. Figure 199 shows the classification results for the male DP-HR interview session in the 0-2000 Hz frequency range.

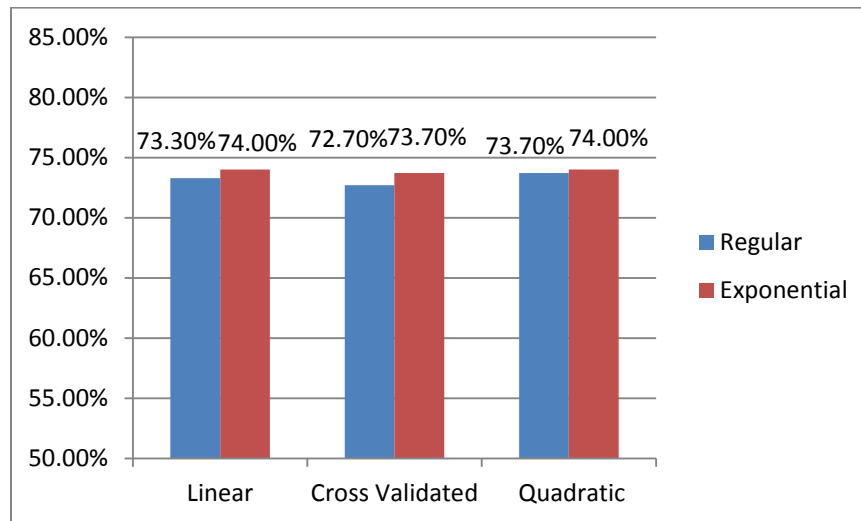

Figure 199: Comparison of Exponential Band Edges and Regular Band Edges for the Male DP- HR Interview (0-2000 Hz)

For the male DP-HR reading session in the 0-2000 Hz frequency range, the exponential energy bands gave classification rate of 74.00%; regular energy bands gave classification rate of 62.50% using the linear classification. According to the cross validated classification, the exponential energy bands gave classification rate of 71.90%; regular energy bands gave classification rate of 60.40%. According to the quadratic classification, the exponential energy bands gave classification rate of 75.00%; regular energy bands gave classification rate of 64.60%. For all three classifiers, the exponential

energy bands gave better classification rates than the regular energy bands. Figure 200 shows the classification results for the male DP-HR reading session in the 0-2000 Hz frequency range.

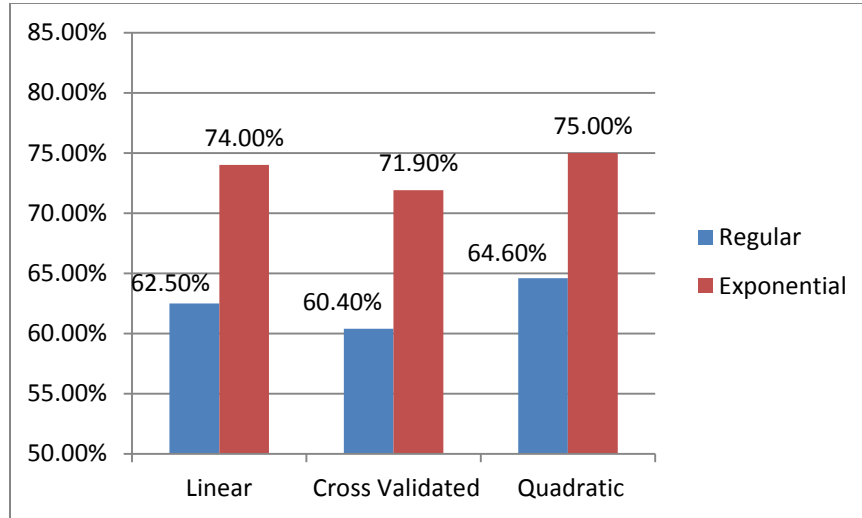

Figure 200: Comparison of Exponential Band Edges and Regular Band Edges for the Male DP- HR Reading (0-2000 Hz)

3.3.1.1.2.2 Male DP – RM Pairwise Group

For the male Depressed – Remitted (DP-RM) interview session in the 0-2000 Hz frequency range, the exponential energy bands gave classification rate of 77.70%; regular energy bands gave classification rate of 83.00% using the linear classification. According to the cross validated classification, the exponential energy bands gave classification rate of 77.40%; regular energy bands gave classification rate of 82.30%. According to the quadratic classification, the exponential energy bands gave classification rate of 81.10%; regular energy bands gave classification rate of 83.00%. For all classifiers, the regular

energy bands gave better results than the exponential energy bands. Figure 201 shows the classification results for the male DP-RM interview session in the 0-2000 Hz frequency range.

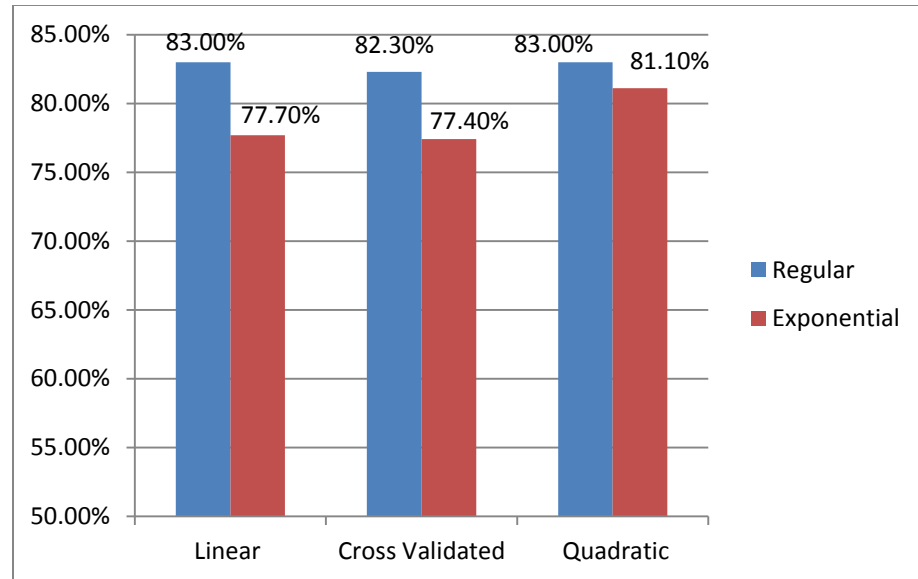

Figure 201: Comparison of Exponential Band Edges and Regular Band Edges for the Male DP- RM Interview (0-2000 Hz)

For the male Depressed – Remitted (DP-RM) reading session in the 0-2000 Hz frequency range, the exponential energy bands gave classification rate of 70.70%; regular energy bands gave classification rate of 73.70% using the linear classification. According to the cross validated classification, the exponential energy bands gave classification rate of 69.70%; regular energy bands gave classification rate of 72.70%. According to the quadratic classification, the exponential energy bands gave classification rate of 74.70%; regular energy bands gave classification rate of 75.80%. For all classifiers, regular energy

bands gave better classification rates than the exponential energy bands. Figure 202 shows the classification results for the male DP-RM reading session in the 0-2000 Hz frequency range.

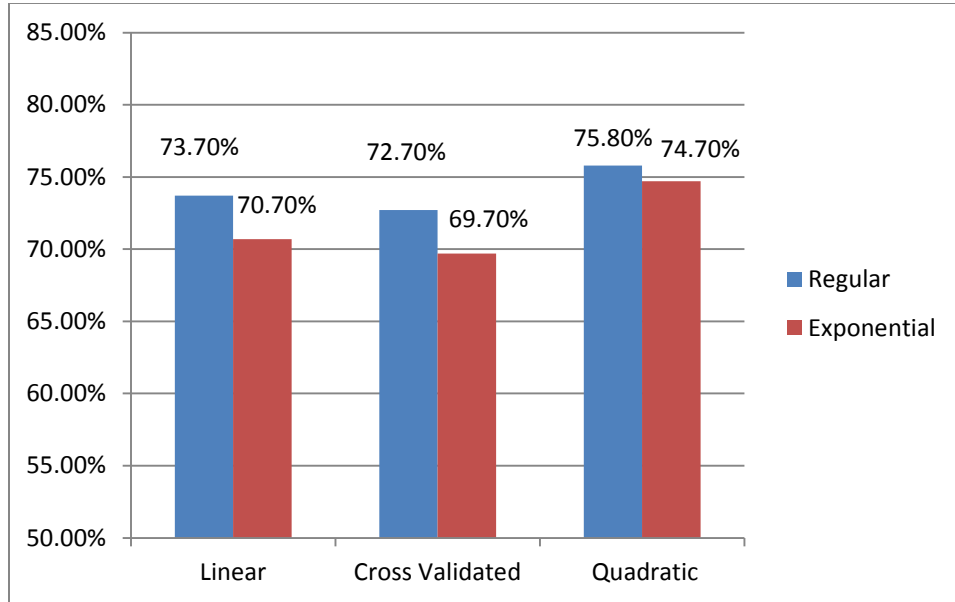

Figure 202: Comparison of Exponential Band Edges and Regular Band Edges for the Male DP- RM Reading (0-2000 Hz)

3.3.1.1.2.3 Male HR – RM Pairwise Group

For the male High Risk Suicidal – Remitted (HR-RM) interview session in the 0-2000 Hz frequency range, the exponential energy bands gave classification rate of 70.20%; regular energy bands gave classification rate of 69.80% using the linear classification. According to the cross validated classification, the exponential energy bands gave classification rate of 69.40%; regular energy bands gave classification rate of 68.10%. For the linear and cross validated classifiers, exponential energy bands gave

slightly better classification rates than the regular energy bands. According to the quadratic classification, the exponential energy bands gave classification rate of 68.10%; regular energy bands gave classification rate of 68.50%. For the quadratic classifier, the regular energy bands gave slightly better results than the exponential energy bands. Figure 203 shows the classification results for the male HR-RM interview session in the 0-2000 Hz frequency range.

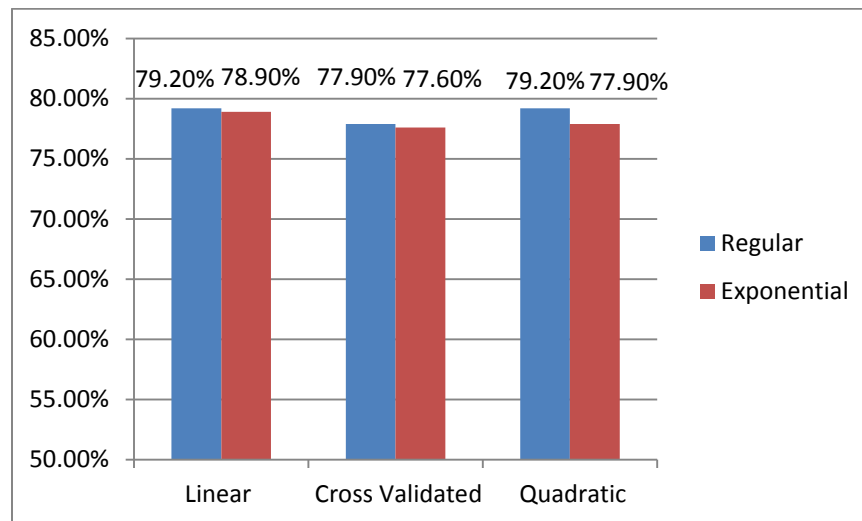

Figure 203: Comparison of Exponential Band Edges and Regular Band Edges for the Male HR- RM Interview (0-2000 Hz)

For the male HR-RM reading session in the 0-2000 Hz frequency range, the exponential energy bands gave classification rate of 72.30%; regular energy bands gave classification rate of 72.30% using the linear classification. With linear classifier, both the exponential and the regular energy bands gave exactly the same classification rates. According to the

cross validated classification, the exponential energy bands gave classification rate of 69.90%; regular energy bands gave classification rate of 72.30%. For the cross validated classifier, the regular energy bands gave better results than the exponential energy bands. According to the quadratic classification, the exponential energy bands gave classification rate of 69.90%; regular energy bands gave classification rate of 67.50%. For the quadratic classifier, the exponential energy bands gave better classification rates than the regular energy bands. Figure 204 shows the classification results for the male HR-RM reading session in the 0-2000 Hz frequency range.

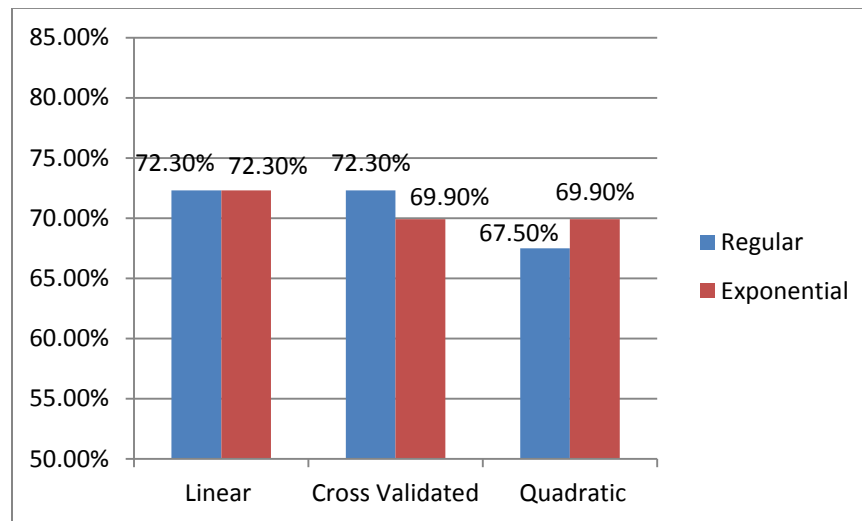

Figure 204: Comparison of Exponential Band Edges and Regular Band Edges for the Male HR- RM Reading (0-2000 Hz)

3.3.1.2 Exponential Band Edges Study in 0 – 3000 Hz Band Range

In this part of the research, four exponential energy bands in the 0 – 3000 Hz frequency range were analyzed. The exponential edges for the exponential energy band

study are 0-375 Hz, 375-750 Hz, 750-1500 Hz, and 1500-3000 Hz. The results were analyzed for the female patients and the male patients during the interview session and reading session and they are shown below.

3.3.1.2.1 Female Patients

3.3.1.2.1.1 Female DP – HR Pairwise Group

In this part of the research, four exponential energy bands in the 0 – 3000 Hz frequency range were analyzed for the Depressed – High Risk Suicidal (DP-HR) pairwise group for the female patients during the interview session were studied. According to the linear classification, the exponential energy bands gave classification rate of 56.70%; regular energy bands gave classification rate of 63.00%. According to the cross validated classification, the exponential energy bands gave classification rate of 56.40%; regular energy bands gave classification rate of 61.50%. According to the quadratic classification, the exponential energy bands gave classification rate of 50.90%; regular energy bands gave classification rate of 55.80%. For all three classifiers, regular energy bands gave better classification rates than the exponential energy bands. Figure 205 shows the classification results for the female DP-HR interview session in the 0-3000 Hz frequency range.

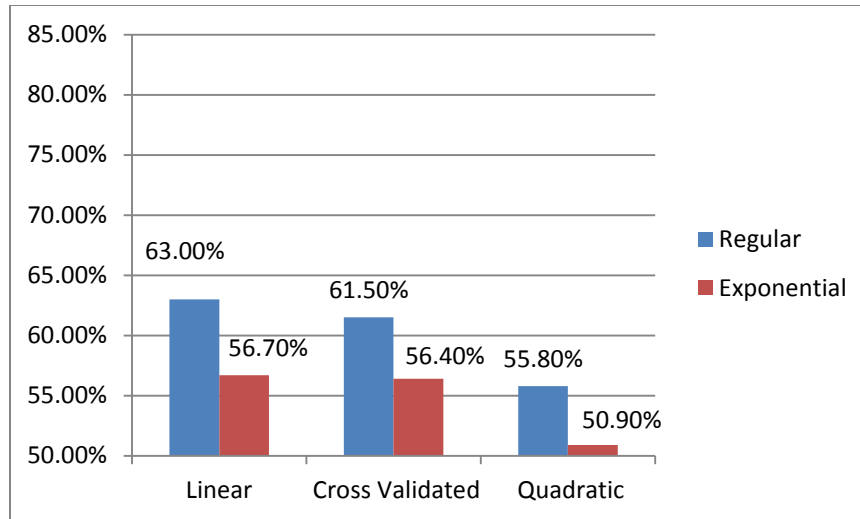

Figure 205: Comparison of Exponential Band Edges and Regular Band Edges for the Female DP - HR Interview (0-3000 Hz)

For the female DP-HR reading session in the 0-3000 Hz frequency range, the exponential energy bands gave classification rate of 67.00%; regular energy bands gave classification rate of 64.10% using the linear classification. According to the cross validated classification, the exponential energy bands gave classification rate of 66.00%; regular energy bands gave classification rate of 61.20%. According to the quadratic classification, the exponential energy bands gave classification rate of 69.90%; regular energy bands gave classification rate of 67.00%. For all three classifiers, exponential energy bands gave better classification rates than the regular energy bands. Figure 206 shows the classification results for the female DP-HR reading session in the 0-3000 Hz frequency range.

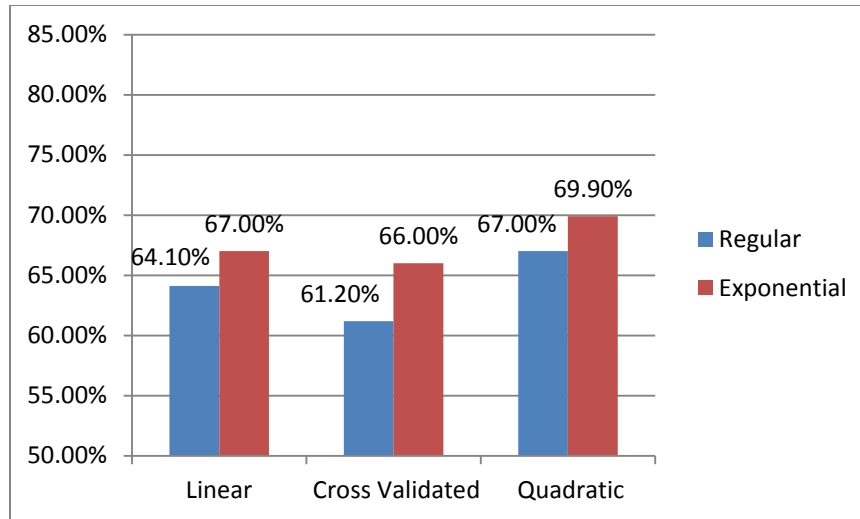

Figure 206: Comparison of Exponential Band Edges and Regular Band Edges for the Female DP - HR Reading (0-3000 Hz)

3.3.1.2.1.2 Female DP – RM Pairwise Group

For the female Depressed – Remitted (DP-RM) interview session in the 0-3000 Hz frequency range, the exponential energy bands gave classification rate of 53.40%; regular energy bands gave classification rate of 63.50% using the linear classification. According to the cross validated classification, the exponential energy bands gave classification rate of 51.80%; regular energy bands gave classification rate of 63.50%. According to the quadratic classification, the exponential energy bands gave classification rate of 58.00%; regular energy bands gave classification rate of 63.00%. For all classifiers, the regular energy bands gave better results than the exponential energy bands. Figure 207 shows the classification results for the female DP-RM interview session in the 0-3000 Hz frequency range.

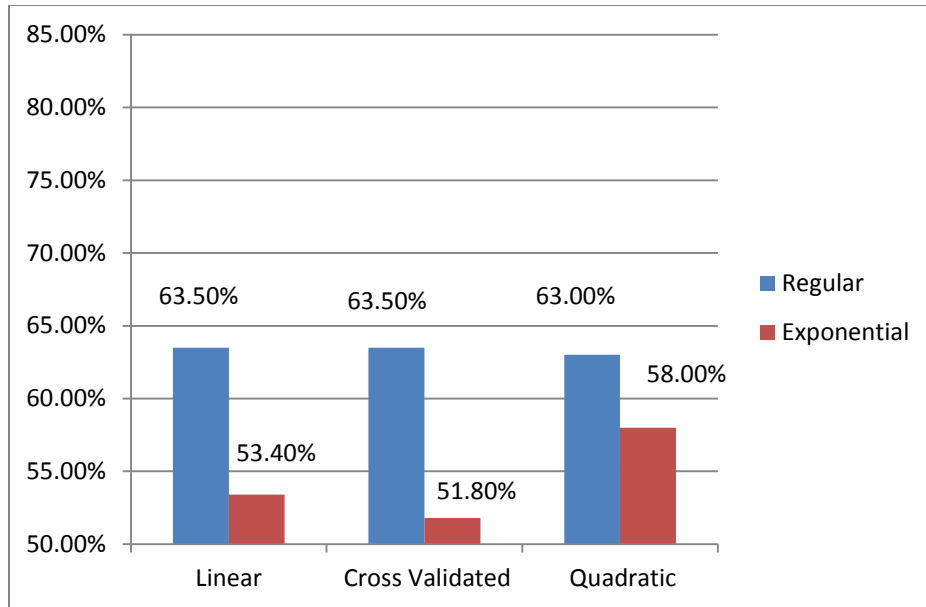

Figure 207: Comparison of Exponential Band Edges and Regular Band Edges for the Female DP - RM Interview (0-3000 Hz)

For the female Depressed – Remitted (DP-RM) reading session in the 0-3000 Hz frequency range, the exponential energy bands gave classification rate of 62.10%; regular energy bands gave classification rate of 67.00% using the linear classification. According to the cross validated classification, the exponential energy bands gave classification rate of 61.20%; regular energy bands gave classification rate of 64.10%. For the linear and cross validated classifiers, the regular energy bands gave better results than the exponential energy bands. According to the quadratic classification, the exponential energy bands gave classification rate of 67.00%; regular energy bands gave classification rate of 62.10%. For the quadratic classifier, the exponential energy bands gave better classification rates than the regular energy bands. Figure 208 shows the classification results for the female DP-RM reading session in the 0-3000 Hz frequency range.

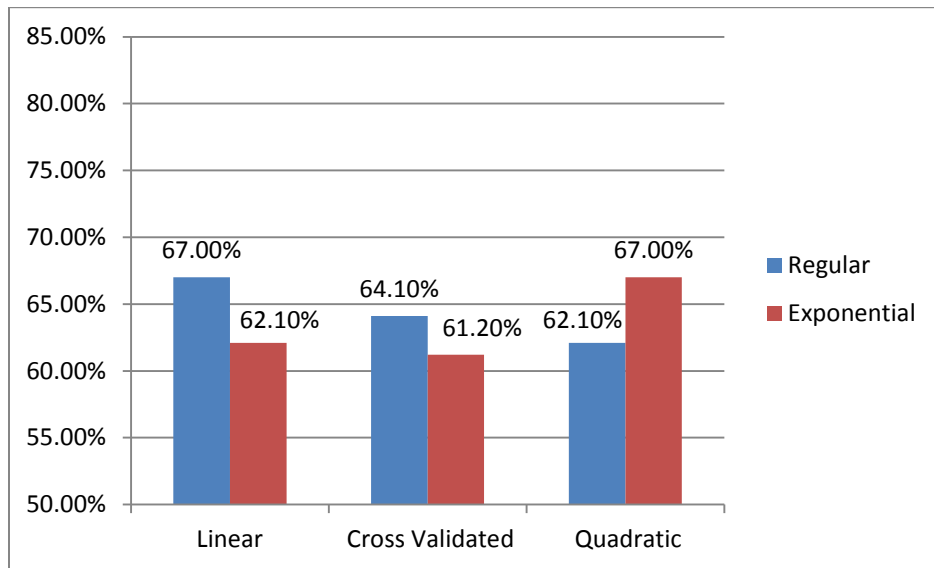

Figure 208: Comparison of Exponential Band Edges and Regular Band Edges for the Female DP - RM Reading (0-3000 Hz)

3.3.1.2.1.3 Female HR – RM Pairwise Group

For the female High Risk Suicidal – Remitted (HR-RM) interview session in the 0-3000 Hz frequency range, the exponential energy bands gave classification rate of 65.70%; regular energy bands gave classification rate of 62.50% using the linear classification. According to the cross validated classification, the exponential energy bands gave classification rate of 64.10%; regular energy bands gave classification rate of 61.30%. According to the quadratic classification, the exponential energy bands gave classification rate of 62.90%; regular energy bands gave classification rate of 53.60%. For all classifiers, the exponential energy bands gave better results than the regular

energy bands. Figure 209 shows the classification results for the female HR-RM interview session in the 0-3000 Hz frequency range.

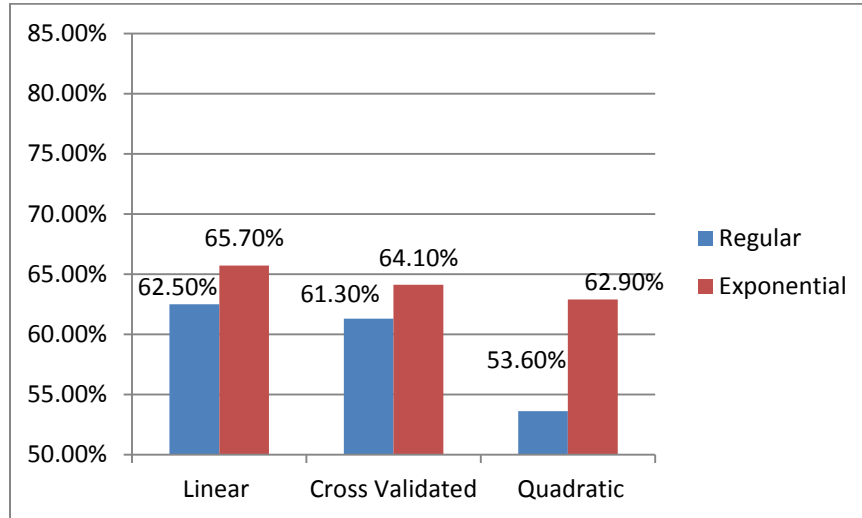

Figure 209: Comparison of Exponential Band Edges and Regular Band Edges for the Female HR - RM Interview (0-3000 Hz)

For the female HR-RM reading session in the 0-3000 Hz frequency range, the exponential energy bands gave classification rate of 72.70%; regular energy bands gave classification rate of 68.20% using the linear classification. According to the cross validated classification, the exponential energy bands gave classification rate of 67.00%; regular energy bands gave classification rate of 63.60%. For both the linear and the cross validated classifiers, exponential energy bands gave better classification rates than the regular energy bands. According to the quadratic classification, the exponential energy bands gave classification rate of 67.00%; regular energy bands gave classification rate of 68.20%. For the quadratic classifier, regular energy bands gave better classification rates

than the exponential energy bands. Figure 210 shows the classification results for the female HR-RM reading session in the 0-3000 Hz frequency range.

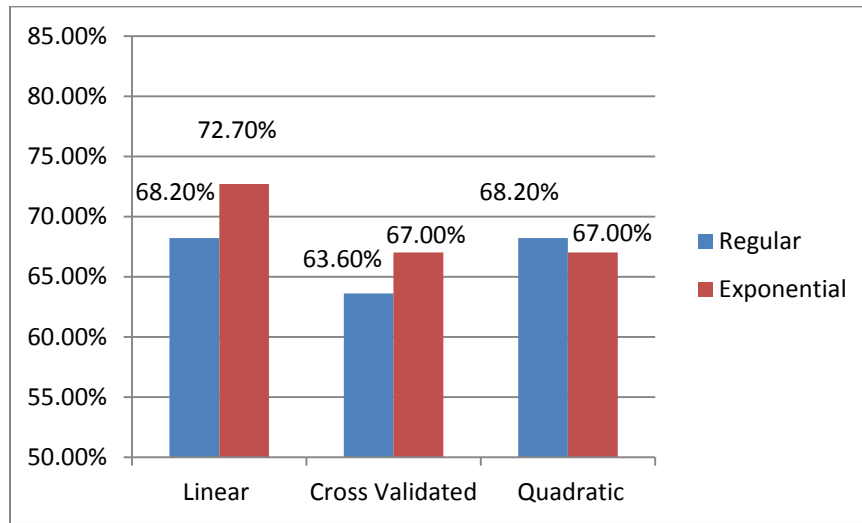

Figure 210: Comparison of Exponential Band Edges and Regular Band Edges for the Female HR - RM Reading (0-3000 Hz)

3.3.1.2.2 Male Patients

3.3.1.2.2.1 Male DP – HR Pairwise Group

Four exponential energy bands in the 0 – 3000 Hz frequency range were analyzed for the Depressed – High Risk Suicidal (DP-HR) pairwise group for the male patients during the interview session were studied. According to the linear classification, the exponential energy bands gave classification rate of 79.00%; regular energy bands gave classification rate of 79.70%. According to the cross validated classification, the exponential energy bands gave classification rate of 79.00%; regular energy bands gave classification rate of 79.40%. According to the quadratic classification, the exponential

energy bands gave classification rate of 79.40%; regular energy bands gave classification rate of 80.00%. For all three classifiers, regular energy bands gave slightly better classification rates than the exponential energy bands. Figure 211 shows the classification results for the male DP-HR interview session in the 0-3000 Hz frequency range.

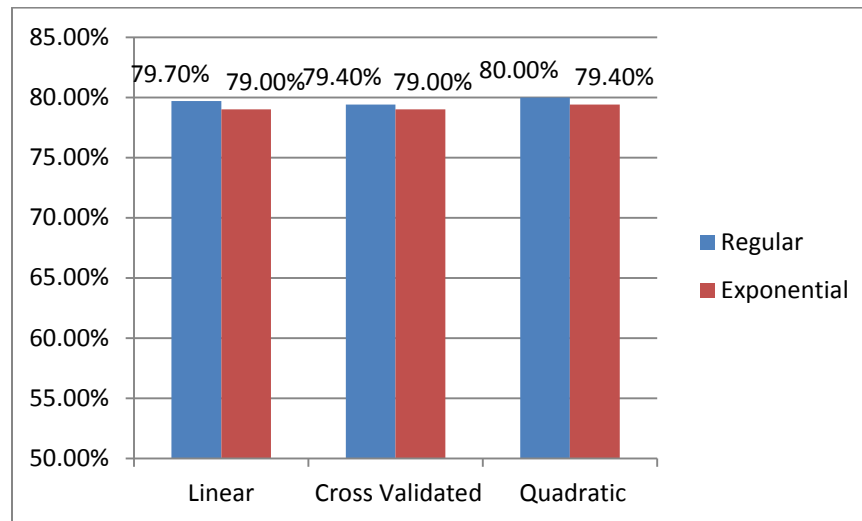

Figure 211: Comparison of Exponential Band Edges and Regular Band Edges for the Male DP – HR Interview (0-3000 Hz)

For the male DP-HR reading session in the 0-3000 Hz frequency range, the exponential energy bands gave classification rate of 65.60%; regular energy bands gave classification rate of 75.00% using the linear classification. According to the cross validated classification, the exponential energy bands gave classification rate of 63.50%; regular energy bands gave classification rate of 74.00%. According to the quadratic classification, the exponential energy bands gave classification rate of 66.70%; regular energy bands gave classification rate of 75.00%. For all three classifiers, regular energy

bands gave better classification rates than the exponential energy bands. Figure 212 shows the classification results for the male DP-HR reading session in the 0-3000 Hz frequency range.

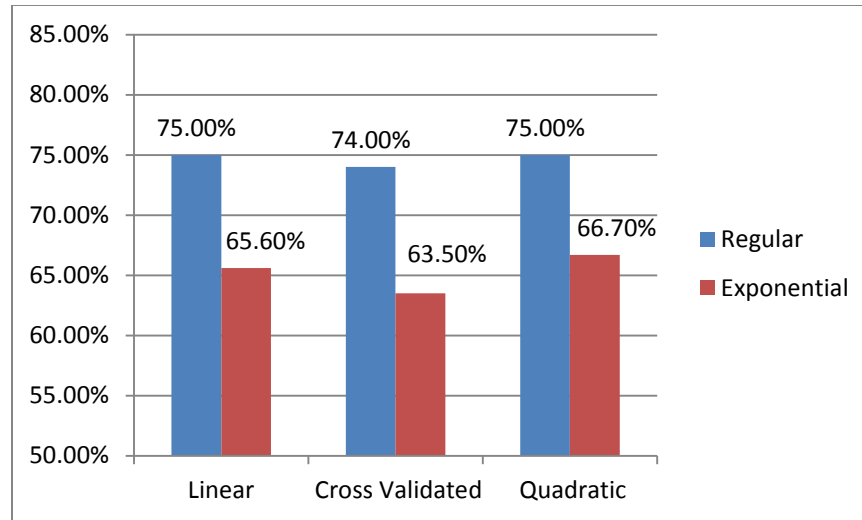

Figure 212: Comparison of Exponential Band Edges and Regular Band Edges for the Male DP – HR Reading (0-3000 Hz)

3.3.1.2.2.2 Male DP – RM Pairwise Group

For the male Depressed – Remitted (DP-RM) interview session in the 0-3000 Hz frequency range, the exponential energy bands gave classification rate of 58.90%; regular energy bands gave classification rate of 58.50% using the linear classification. According to the cross validated classification, the exponential energy bands gave classification rate of 58.50%; regular energy bands gave classification rate of 55.50%. According to the quadratic classification, the exponential energy bands gave classification rate of 61.10%; regular energy bands gave classification rate of 60.00%. For all classifiers, the exponential energy bands gave better results than the regular energy bands. Figure 213 shows the classification results for the male DP-RM interview session in the 0-3000 Hz frequency range.

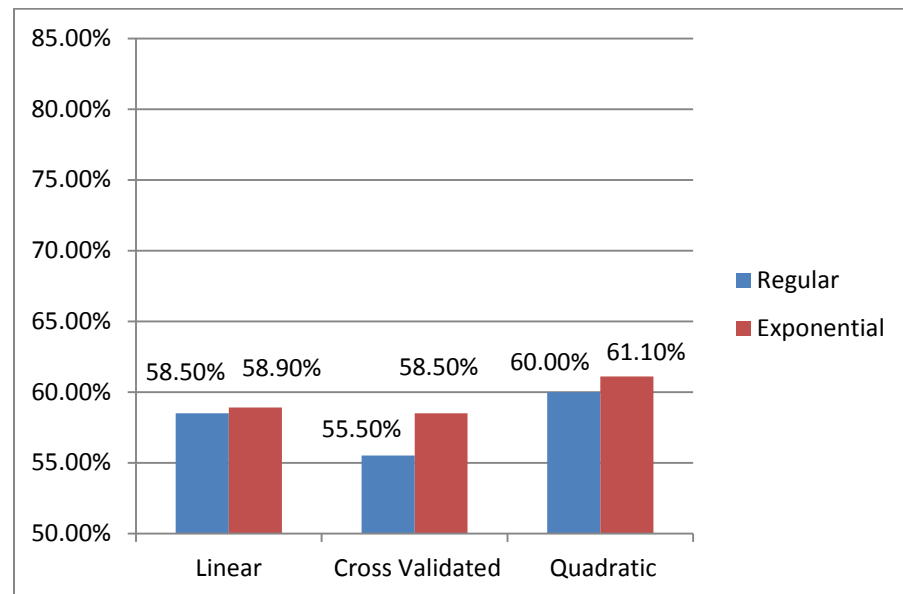

Figure 213: Comparison of Exponential Band Edges and Regular Band Edges for the Male DP – RM Interview (0-3000 Hz)

For the male Depressed – Remitted (DP-RM) reading session in the 0-3000 Hz frequency range, the exponential energy bands gave classification rate of 68.70%; regular energy bands gave classification rate of 63.60% using the linear classification. According to the cross validated classification, the exponential energy bands gave classification rate of 68.70%; regular energy bands gave classification rate of 62.60%. According to the quadratic classification, the exponential energy bands gave classification rate of 69.70%; regular energy bands gave classification rate of 65.70%. For all classifiers, exponential energy bands gave better classification rates than the regular energy bands. Figure 214 shows the classification results for the male DP-RM reading session in the 0-3000 Hz frequency range.

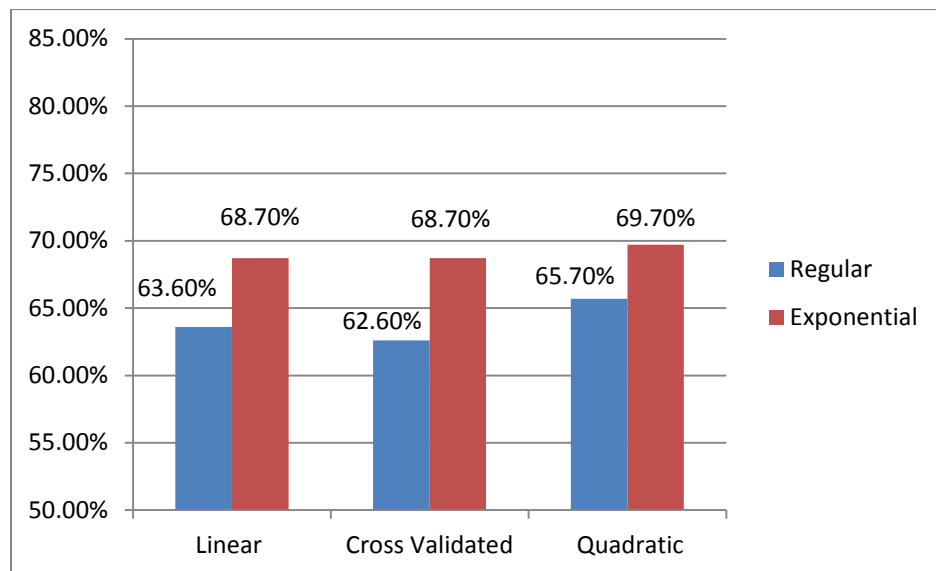

Figure 214: Comparison of Exponential Band Edges and Regular Band Edges for the Male DP – RM Reading (0-3000 Hz)

3.3.1.2.2.3 Male HR – RM Pairwise Group

For the male High Risk Suicidal – Remitted (HR-RM) interview session in the 0-3000 Hz frequency range, the exponential energy bands gave classification rate of 82.80%; regular energy bands gave classification rate of 84.10% using the linear classification. According to the cross validated classification, the exponential energy bands gave classification rate of 82.50%; regular energy bands gave classification rate of 84.10%. According to the quadratic classification, the exponential energy bands gave classification rate of 82.80%; regular energy bands gave classification rate of 83.80%. For all classifiers, the regular energy bands gave slightly better results than the exponential energy bands. Figure 215 shows the classification results for the male HR-RM interview session in the 0-3000 Hz frequency range.

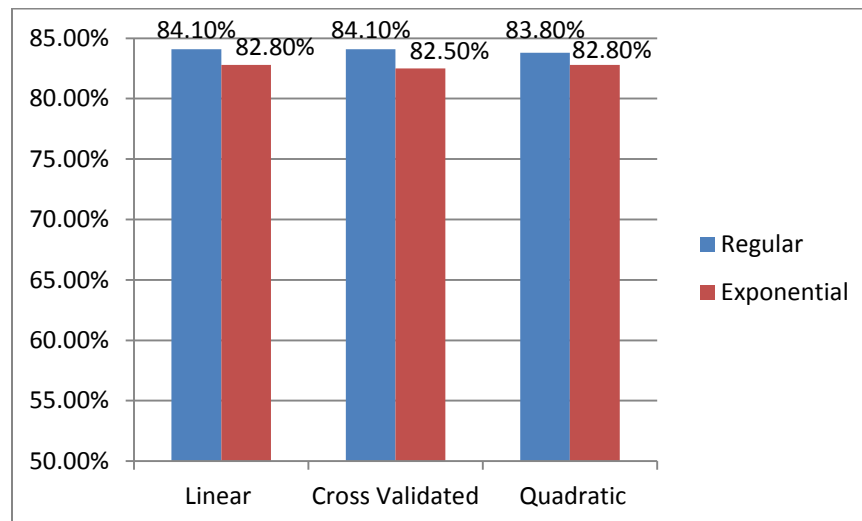

Figure 215: Comparison of Exponential Band Edges and Regular Band Edges for the Male HR – RM Interview (0-3000 Hz)

For the male HR-RM reading session in the 0-3000 Hz frequency range, the exponential energy bands gave classification rate of 79.50%; regular energy bands gave classification rate of 80.70% using the linear classification. According to the cross validated classification, the exponential energy bands gave classification rate of 77.10%; regular energy bands gave classification rate of 79.50%. According to the quadratic classification, the exponential energy bands gave classification rate of 75.90%; regular energy bands gave classification rate of 79.50%. For all classifiers, regular energy bands gave better classification rates than the exponential energy bands. Figure 216 shows the classification results for the male HR-RM reading session in the 0-3000 Hz frequency range.

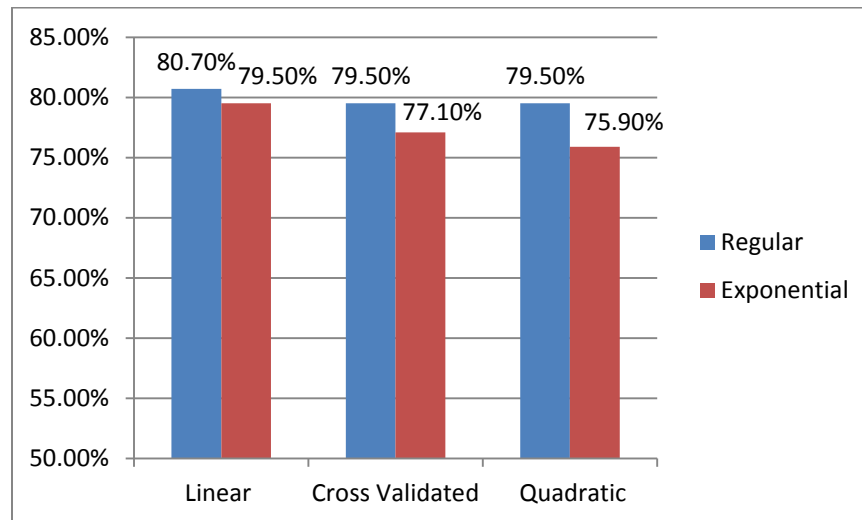

Figure 216: Comparison of Exponential Band Edges and Regular Band Edges for the Male HR – RM Reading (0-3000 Hz)

All of the results of the comparison for the exponential band edge study and regular band edge study with different pairwise groups' comparisons (DP-HR, DP-RM, HR-RM) of

female and male patients during the interview and reading sessions with different band ranges (0-2000 Hz and 0-3000 Hz) are shown in the following three tables below. In this research three different classification techniques were used. The linear classification results are shown in Table 65. The cross validated classification results are shown in Table 66. The quadratic classification results are shown in Table 67.

Table 65: Exponential vs. Regular Band Edges Comparison Results with Linear Classification

	FEMALE		Linear Classification	
	0- 2000 Hz Interview	0- 2000 Hz Reading	0- 3000 Hz Interview	0- 3000 Hz Reading
DP - HR	Exponential	Exponential	Regular	Exponential
DP - RM	Exponential	Same	Regular	Regular
HR - RM	Exponential	Exponential	Exponential	Exponential
	MALE		Linear Classification	
	0- 2000 Hz Interview	0- 2000 Hz Reading	0- 3000 Hz Interview	0- 3000 Hz Reading
DP - HR	Exponential	Exponential	Regular	Regular
DP - RM	Regular	Regular	Exponential	Exponential
HR - RM	Regular	Same	Regular	Regular

Table 66: Exponential vs. Regular Band Edges Comparison Results with Cross Validated Classification

	FEMALE		Cross Validated Classification	
	0- 2000 Hz Interview	0- 2000 Hz Reading	0- 3000 Hz Interview	0- 3000 Hz Reading
DP - HR	Exponential	Exponential	Regular	Exponential
DP - RM	Exponential	Regular	Regular	Regular
HR - RM	Exponential	Exponential	Exponential	Exponential
	MALE		Cross Validated Classification	
	0- 2000 Hz Interview	0- 2000 Hz Reading	0- 3000 Hz Interview	0- 3000 Hz Reading
DP - HR	Exponential	Exponential	Regular	Regular
DP - RM	Regular	Regular	Exponential	Exponential
HR - RM	Regular	Regular	Regular	Regular

Table 67: Exponential vs. Regular Band Edges Comparison Results with Quadratic Classification

	FEMALE		Quadratic Classification	
	0- 2000 Hz Interview	0- 2000 Hz Reading	0- 3000 Hz Interview	0- 3000 Hz Reading
DP - HR	Exponential	Exponential	Regular	Exponential
DP - RM	Regular	Exponential	Regular	Exponential
HR - RM	Regular	Exponential	Exponential	Regular
	MALE		Quadratic Classification	
	0- 2000 Hz Interview	0- 2000 Hz Reading	0- 3000 Hz Interview	0- 3000 Hz Reading
DP - HR	Exponential	Exponential	Regular	Regular
DP - RM	Regular	Regular	Exponential	Exponential
HR - RM	Regular	Exponential	Regular	Regular

3.3.2 Non Uniform Band Edges

In this part of the research, two different set of band edges were analyzed. One of them is between the band edges in the 0 – 2000 Hz frequency range and the other one is

the band edges in the 0 – 3000 Hz frequency range. For the non-uniform band edges study, the band edge frequency range is swept in between the 0 – 2000 Hz frequency range with 250 Hz frequency increment. Thirty five different combinations of non-uniform energy bands edges were found in the 0 – 2000 Hz frequency range. One hundred and sixty five different combinations of non-uniform energy bands edges were determined in the 0 – 3000 Hz frequency range by sweeping the 0 – 3000 Hz frequency range with the 250 Hz frequency increment. This subchapter will show the results of this study.

3.3.2.1 Non Uniform Band Edges in the 0 – 2000 Hz Frequency Range

For the non-uniform band edges study, the band edge frequency range is swept in between 0 – 2000 Hz frequency range with 250 Hz frequency increment. Thirty five different combinations of non-uniform energy bands edges were used in the 0 – 2000 Hz frequency range. This study is done with fixed number of bands for only one pairwise group which is Depressed – High Risk Suicidal pair (DP-HR). Four energy bands (PSD1, PSD2, PSD3, and PSD4) were analyzed in this study with using two classification methods (linear and quadratic). The following table, Table 68, will show the non-uniform band edges and 35 possible energy bands that are created with these edges.

Table 68: Possible Four Energy Bands in Non-Uniform Band Study in 0- 2000 Hz

	X1	X2	X3	PSD 1	PSD 2	PSD 3	PSD 4
1	250	500	750	0 - 250 Hz	250 - 500 Hz	500 - 750 Hz	750 - 2000 Hz
2	250	500	1000	0 - 250 Hz	250 - 500 Hz	500 - 1000 Hz	1000 - 2000 Hz
3	250	500	1250	0 - 250 Hz	250 - 500 Hz	500 - 1250 Hz	1250 - 2000 Hz
4	250	500	1500	0 - 250 Hz	250 - 500 Hz	500 - 1500 Hz	1500 - 2000 Hz
5	250	500	1750	0 - 250 Hz	250 - 500 Hz	500- 1750 Hz	1750 - 2000 Hz
6	250	750	1000	0 - 250 Hz	250 - 750 Hz	750- 1000 Hz	1000 - 2000 Hz
7	250	750	1250	0 - 250 Hz	250 - 750 Hz	750 -1250 Hz	1250 - 2000 Hz
8	250	750	1500	0 - 250 Hz	250 - 750 Hz	750 - 1500 Hz	1500 -2000 Hz
9	250	750	1750	0 - 250 Hz	250 - 750 Hz	750 - 1750 Hz	1750 - 2000 Hz
10	250	1000	1250	0 - 250 Hz	250 - 1000 Hz	1000 - 1250 Hz	1250 - 2000 Hz
11	250	1000	1500	0 - 250 Hz	250 - 1000 Hz	1000 - 1500 Hz	1500 - 2000 Hz
12	250	1000	1750	0 - 250 Hz	250 - 1000 Hz	1000 - 1750 Hz	1750 - 2000 Hz
13	250	1250	1500	0 - 250 Hz	250 - 1250 Hz	1250 - 1500 Hz	1500 - 2000 Hz
14	250	1250	1750	0 - 250 Hz	250 - 1250 Hz	1250 - 1750 Hz	1750 - 2000 Hz
15	250	1500	1750	0 - 250 Hz	250 - 1500 Hz	1500 - 1750 Hz	1750 - 2000 Hz
16	500	750	1000	0 - 500 Hz	500 - 750 Hz	750 - 1000 Hz	1000 - 2000 Hz
17	500	750	1250	0 - 500 Hz	500 - 750 Hz	750 - 1250 Hz	1250 - 2000 Hz
18	500	750	1500	0 - 500 Hz	500 - 750 Hz	750 - 1500 Hz	1500 - 2000 Hz
19	500	750	1750	0 - 500 Hz	500 - 750 Hz	750 - 1750 Hz	1750 - 2000 Hz
20	500	1000	1250	0 - 500 Hz	500 - 1000 Hz	1000 - 1250 Hz	1250 - 2000 Hz
21	500	1000	1500	0 - 500 Hz	500 - 1000 Hz	1000 - 1500 Hz	1500 - 2000 Hz
22	500	1000	1750	0 - 500 Hz	500 - 1000 Hz	1000 - 1750 Hz	1750 - 2000 Hz
23	500	1250	1500	0 - 500 Hz	500 - 1250 Hz	1250 - 1500 Hz	1500 - 2000 Hz
24	500	1250	1750	0 - 500 Hz	500 - 1250 Hz	1250 - 1750 Hz	1750 - 2000 Hz
25	500	1500	1750	0 - 500 Hz	500 - 1500 Hz	1500 - 1750 Hz	1750 - 2000 Hz
26	750	1000	1250	0- 750 Hz	750 - 1000 Hz	1000 - 1250 Hz	1250 - 2000 Hz
27	750	1000	1500	0- 750 Hz	750 - 1000 Hz	1000 - 1500 Hz	1500 - 2000 Hz
28	750	1000	1750	0- 750 Hz	750 - 1000 Hz	1000 - 1750 Hz	1750 - 2000 Hz
29	750	1250	1500	0- 750 Hz	750 - 1250 Hz	1250 - 1500 Hz	15000 - 2000 Hz
30	750	1250	1750	0- 750 Hz	750 - 1250 Hz	1250 - 1750 Hz	1750 - 2000 Hz
31	750	1500	1750	0- 750 Hz	750 - 1500 Hz	1500 - 1750 Hz	1750 - 2000 Hz
32	1000	1250	1500	0 - 1000 Hz	1000 - 1250 Hz	1250 - 1500 Hz	1500 - 2000 Hz
33	1000	1250	1750	0 - 1000 Hz	1000 - 1250 Hz	1250 - 1750 Hz	1750 - 2000 Hz
34	1000	1500	1750	0 - 1000 Hz	1000 - 1500 Hz	1500 - 1750 Hz	1750 - 2000 Hz
35	1250	1500	1750	0 - 1250 Hz	1250 - 1500 Hz	1500 - 1750 Hz	1750 - 2000 Hz

3.3.2.1.1 Female DP – HR Pairwise Group during the Interview Session

The following figures show the classification results for the female DP-HR pairwise group during the interview session. Figure 217 shows the classification rates using the linear classifier. According to linear classifier, the maximum classification rate found as 71.835% for the 2nd data point (250, 500, 1000) which means the following PSD combination(**PSD 1:** 0 -250 Hz, **PSD 2:** 250-500 Hz, **PSD 3:** 500-1000 Hz, **PSD 4:**1000-2000 Hz).

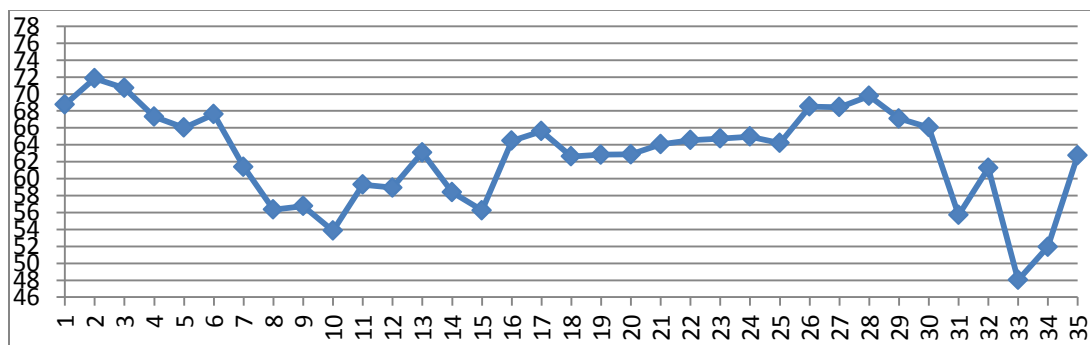

Figure 217: Non Uniform Band Edges Classification Results for the Female DP – HR Interview with 0 – 2000 Hz Band Range with Linear Classifier

Figure 218 shows the classification rates using the quadratic classifier for the female DP-HR pairwise group during the interview session. According to quadratic classifier, the maximum classification rate found as 76.896% for the 2nd data point (250, 500, 1000) which means the following PSD combination(**PSD 1:** 0 -250 Hz, **PSD 2:** 250-500 Hz, **PSD 3:** 500-1000 Hz, **PSD 4:**1000-2000 Hz).

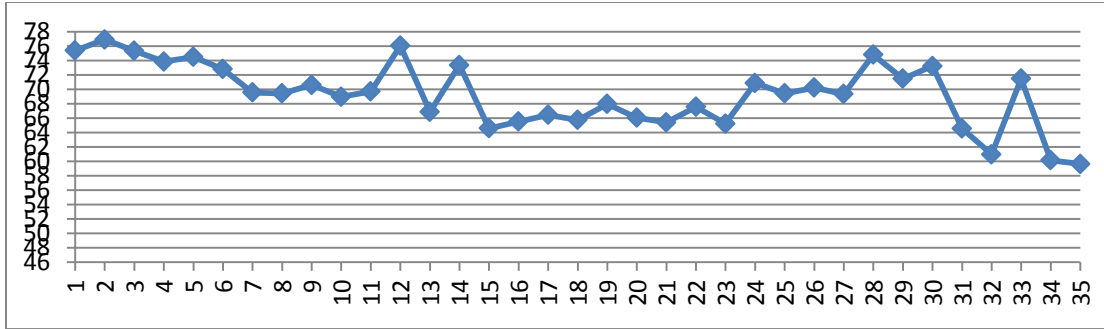

Figure 218: Non Uniform Band Edges Classification Results for the Female DP – HR Interview with 0 – 2000 Hz Band Range with Quadratic Classifier

3.3.2.1.2 Female DP – HR Pairwise Group during the Reading Session

The following figures show the classification results for the female DP-HR pairwise group during the reading session. Figure 219 shows the classification rates using the linear classifier. According to the linear classifier, the maximum classification rate found as 74.249% for the 6th data point (250, 750, 1000) which means the following PSD combination(**PSD 1:** 0 -250 Hz, **PSD 2:** 250-750 Hz, **PSD 3:** 750-1000 Hz, **PSD 4:**1000-2000 Hz).

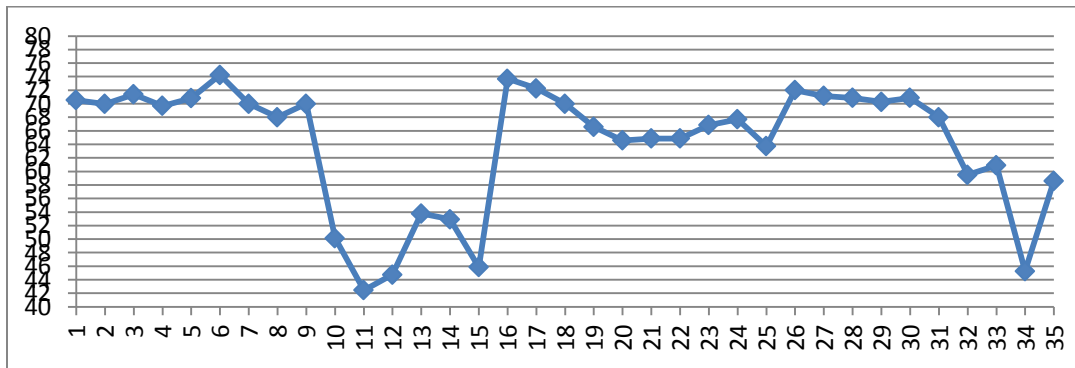

Figure 219: Non Uniform Band Edges Classification Results for the Female DP – HR Reading with 0 – 2000 Hz Band Range with Linear Classifier

Figure 220 shows the classification rates using the quadratic classifier for the female DP-HR pairwise group during the reading session. According to quadratic classifier, the maximum classification rate found as 77.60% for the 3rd data point (250, 500, 1250) and 4th data point (250, 500, 1500). The data points mean the following PSD combinations.

- 3rd data point → **PSD 1:** 0 -250 Hz, **PSD 2:** 250-500 Hz, **PSD 3:** 500-1250 Hz, **PSD 4:**1250-2000 Hz
- 4th data point → **PSD 1:** 0 -250 Hz, **PSD 2:** 250-500 Hz, **PSD 3:** 500-1500 Hz, **PSD 4:**1500-2000 Hz

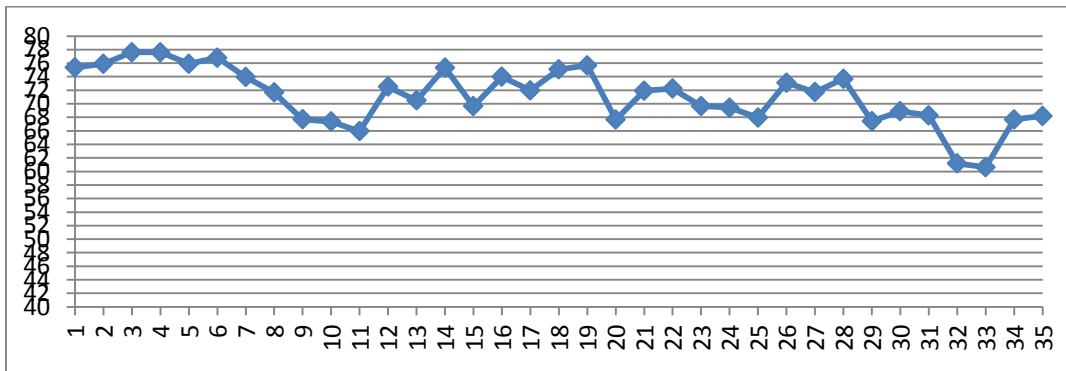

Figure 220: Non Uniform Band Edges Classification Results for the Female DP – HR Reading with 0 – 2000 Hz Band Range with Quadratic Classifier

3.3.2.1.3 Male DP – HR Pairwise Group during the Interview Session

The following figures show the classification results for the male DP-HR pairwise group during the interview session. Figure 221 shows the classification rates using the linear classifier. According to linear classifier, the maximum classification rate found as 79.046 % for the four different data points. They are 8th data point (250, 750, 1500), 15th

data point (250, 1500, 1750), 18th data point (500, 750, 1500) and 25th data point (500, 1500, 1750). The data points mean the following PSD combinations.

- 8th data point → **PSD 1:** 0 -250 Hz, **PSD 2:** 250-750 Hz, **PSD 3:** 750-1500 Hz, **PSD 4:** 1500-2000 Hz
- 15th data point → **PSD 1:** 0 -250 Hz, **PSD 2:** 250-1500 Hz, **PSD 3:** 1500-1750 Hz, **PSD 4:** 1750-2000 Hz
- 18th data point → **PSD 1:** 0 -500 Hz, **PSD 2:** 500-750 Hz, **PSD 3:** 750-1500 Hz, **PSD 4:** 1500-2000 Hz
- 25th data point → **PSD 1:** 0 -500 Hz, **PSD 2:** 500-1500 Hz, **PSD 3:** 1500-1750 Hz, **PSD 4:** 1750-2000 Hz

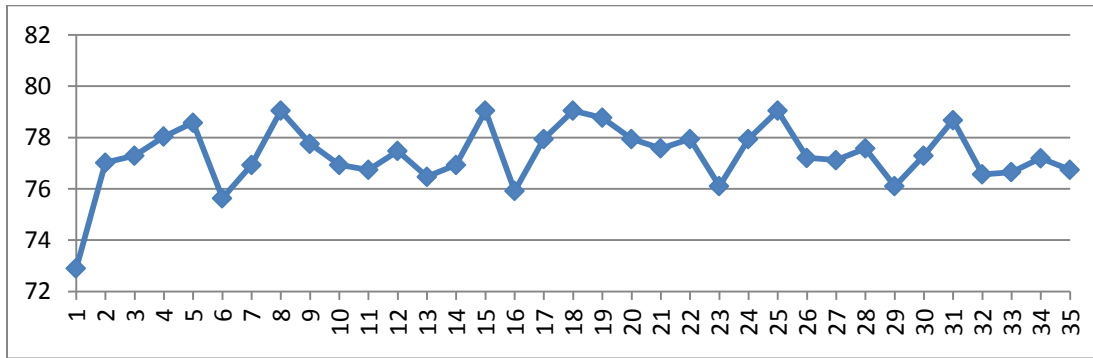

Figure 221: Non Uniform Band Edges Classification Results for the Male DP – HR Interview with 0 – 2000 Hz Band Range with Linear Classifier

Figure 222 shows the classification rates using the quadratic classifier for the male DP-HR pairwise group during the interview session. According to quadratic classifier, the

maximum classification rate found as 80.987% for the 18th data point (500, 750, 1500) which means the following PSD combination(**PSD 1:** 0 -500 Hz, **PSD 2:** 500-750 Hz, **PSD 3:** 750-1500 Hz, **PSD 4:**1500-2000 Hz).

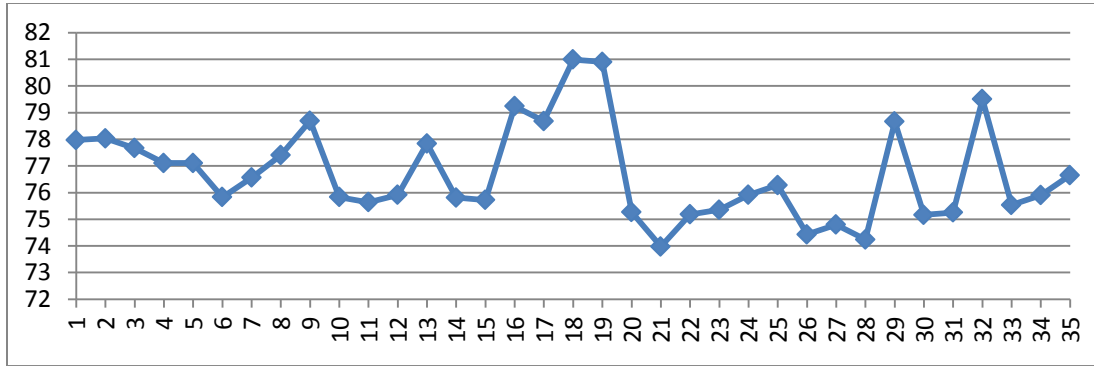

Figure 222: Non Uniform Band Edges Classification Results for the Male DP – HR Interview with 0 – 2000 Hz Band Range with Quadratic Classifier

3.3.2.1.4 Male DP – HR Pairwise Group during the Reading Session

The following figures show the classification results for the male DP-HR pairwise group during the reading session. Figure 223 shows the classification rates using the linear classifier. According to linear classifier, the maximum classification rate found as 81.071% for the 15th data point (250, 1500, 1750) which means the following PSD combination(**PSD 1:** 0 -250 Hz, **PSD 2:** 250-1500 Hz, **PSD 3:** 1500-1750 Hz, **PSD 4:**1750-2000 Hz).

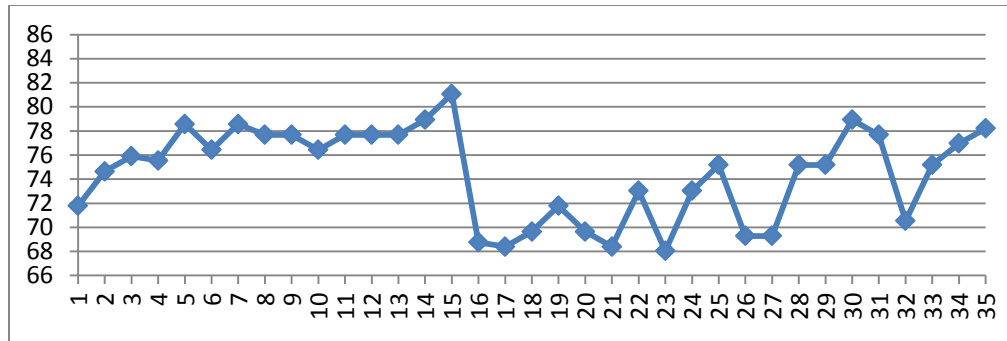

Figure 223: Non Uniform Band Edges Classification Results for the Male DP – HR Reading with 0 – 2000 Hz Band Range with Linear Classifier

Figure 224 shows the classification rates using the quadratic classifier for the male DP-HR pairwise group during the reading session. According to the quadratic classifier, the maximum classification rate found as 84.107% for the 5th data point (250, 500, 1750) which means the following PSD combination(**PSD 1:** 0 -250 Hz, **PSD 2:** 250-500 Hz, **PSD 3:** 500-1750 Hz, **PSD 4:**1750-2000 Hz).

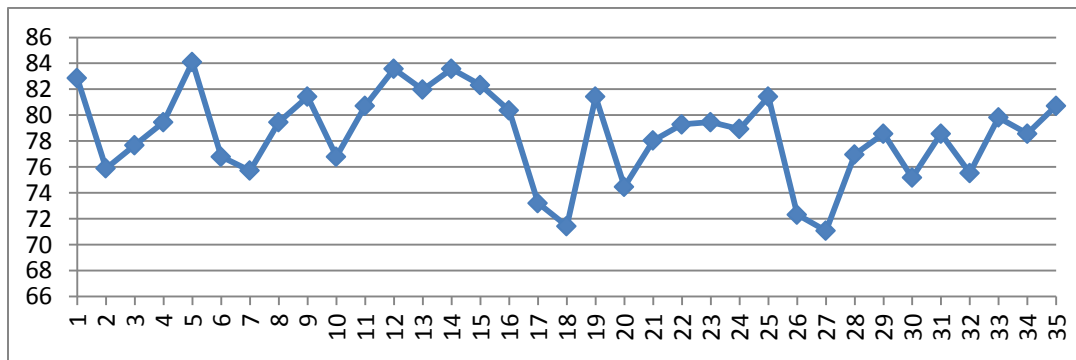

Figure 224: Non Uniform Band Edges Classification Results for the Male DP – HR Reading with 0 – 2000 Hz Band Range with Quadratic Classifier

Table 69 shows the band edges and the classification results for the DP- HR pairwise group for both the female and the male patients during the interview and the reading sessions with two different classification methods (linear classification, quadratic classification).

Table 69: Non Uniform Band Edges Classification Results for the DP – HR Pair with 0 – 2000 Hz Band Range

	Non-Uniform Band Edges			Linear (0 -2000 Hz)				Quadratic (0-2000 Hz)			
				Male		Female		Male		Female	
	X1	X2	X3	DP-HR	DP-HR	DP-HR	DP-HR	DP-HR	DP-HR	DP-HR	DP-HR
			INT	RNB	INT	RNB	INT	RNB	INT	RNB	
1	250	500	750	72.901	71.786	68.75	70.532	77.974	82.857	75.374	75.347
2	250	500	1000	77.017	74.643	71.835	69.973	78.032	75.893	76.896	75.905
3	250	500	1250	77.296	75.893	70.7	71.379	77.664	77.679	75.334	77.6
4	250	500	1500	78.032	75.536	67.308	69.684	77.105	79.464	73.838	77.6
5	250	500	1750	78.576	78.571	66.026	70.82	77.105	84.107	74.479	75.905
6	250	750	1000	75.635	76.429	67.601	74.249	75.826	76.786	72.796	76.791
7	250	750	1250	76.929	78.571	61.392	69.992	76.561	75.714	69.551	73.941
8	250	750	1500	79.046	77.679	56.343	68.008	77.399	79.464	69.431	71.668
9	250	750	1750	77.752	77.679	56.771	69.992	78.693	81.429	70.593	67.7
10	250	1000	1250	76.929	76.429	53.846	50.135	75.826	76.786	68.95	67.373
11	250	1000	1500	76.738	77.679	59.295	42.469	75.635	80.714	69.685	65.948
12	250	1000	1750	77.473	77.679	58.934	44.742	75.914	83.571	76.028	72.515
13	250	1250	1500	76.473	77.679	63.088	53.775	77.841	81.964	66.867	70.493
14	250	1250	1750	76.929	78.929	58.387	52.928	75.811	83.571	73.357	75.327
15	250	1500	1750	79.046	81.071	56.25	45.859	75.723	82.321	64.583	69.646
16	500	750	1000	75.914	68.75	64.476	73.69	79.237	80.357	65.518	73.979
17	500	750	1250	77.943	68.393	65.612	72.265	78.679	73.214	66.44	71.976
18	500	750	1500	79.046	69.643	62.62	69.992	80.987	71.429	65.745	75.077
19	500	750	1750	78.767	71.786	62.834	66.583	80.899	81.429	67.949	75.655
20	500	1000	1250	77.943	69.643	62.861	64.58	75.267	74.464	66.052	67.662
21	500	1000	1500	77.576	68.393	64.049	64.869	73.973	78.036	65.411	71.938
22	500	1000	1750	77.943	73.036	64.543	64.869	75.179	79.286	67.548	72.246
23	500	1250	1500	76.105	68.036	64.744	66.853	75.355	79.464	65.224	69.665
24	500	1250	1750	77.943	73.036	64.971	67.7	75.914	78.929	70.86	69.414
25	500	1500	1750	79.046	75.179	64.209	63.733	76.282	81.429	69.431	67.951
26	750	1000	1250	77.208	69.286	68.51	71.995	74.429	72.321	70.219	73.112
27	750	1000	1500	77.12	69.286	68.443	71.148	74.797	71.071	69.324	71.706
28	750	1000	1750	77.576	75.179	69.765	70.859	74.238	76.964	74.8	73.69
29	750	1250	1500	76.105	75.179	67.094	70.281	78.664	78.571	71.461	67.45
30	750	1250	1750	77.296	78.929	66.066	70.859	75.164	75.179	73.21	68.875
31	750	1500	1750	78.679	77.679	55.702	68.008	75.253	78.571	64.543	68.297
32	1000	1250	1500	76.561	70.536	61.258	59.495	79.502	75.536	60.964	61.171
33	1000	1250	1750	76.649	75.179	48.024	60.901	75.532	79.821	71.474	60.632
34	1000	1500	1750	77.194	76.964	51.936	45.281	75.9	78.571	60.15	67.681
35	1250	1500	1750	76.738	78.214	62.727	58.59	76.649	80.714	59.629	68.201

Table 70 shows the averages and some other statistics of the classification results for the DP- HR pairwise group for both the female and the male patients with two different classification methods of linear classification and quadratic classification for the 0-2000 Hz frequency band range.

Table 70: Non Uniform Band Edges Classification Averages for the DP – HR Pair with 0 – 2000 Hz Band Range

DP- HR PAIR	Linear (0 -2000 Hz)				Quadratic(0-2000 Hz)			
	Male INT	Male RNB	Female INT	Female RNB	Male INT	Male RNB	Female INT	Female RNB
Average	77.318	74.531	62.771	64.203	76.715	78.505	69.249	71.147
Std. Dev	1.197	3.757	5.451	9.085	1.767	3.397	4.448	4.153
Min	72.901	68.036	48.024	42.469	73.973	71.071	59.629	60.632
Max	79.046	81.071	71.835	74.249	80.987	84.107	76.896	77.600

Table 71 shows the highest classification results and the associated data points for these results for the DP- HR pairwise group for the female patients with two different classification methods of linear classification and quadratic classification for the 0-2000 Hz frequency band range with different session. According to the results, quadratic classification gave better results for both the interview and the reading sessions.

Table 71: Optimized Non Uniform Band Edges Classification Rates for the DP – HR Pair with the 0 – 2000 Hz Band Range for the Female Patients

FEMALE PATIENTS (0 – 2000 Hz)						
Pairwise Group	Fixed Band Number (Optimized Non-Uniform Band Edges)		Classification Rate		Data Point	
	Linear	Quadratic	Linear	Quadratic	Linear	Quadratic
<u>DP – HR Interview</u>	4 bands	4 bands	71.835%	76.896%	2 nd point (250,500,1000)	2 nd point (250,500,1000)
<u>DP – HR Reading</u>	4 bands	4 bands	74.249%	77.60%	6 th point (250,750,1000)	3 rd point (250,500,1250) & 4 th point (250,500,1500)

The table below (Table 72) shows the highest classification results and the associated data points for these results for the DP- HR pairwise group for the male patients with two different classification methods of linear classification and quadratic classification for the 0-2000 Hz frequency band range with different session. According to the results, quadratic classification gave better results for both the interview and the reading sessions.

Table 72: Optimized Non Uniform Band Edges Classification Rates for the DP – HR Pair with 0 – 2000 Hz Band Range for the Male Patient

MALE PATIENTS (0 – 2000 Hz)							
Pairwise Group	Fixed Band Number (Optimized Non-Uniform Band Edges)		Classification Rate		Data Point		
	Linear	Quadratic	Linear	Quadratic	Linear	Quadratic	
<u>DP – HR Interview</u>	4 bands	4 bands	79.046%	80.987%	8 th point (250,750,1500) & 15 th point (250,1500,1750) & 18 th point (500,750,1500) & 25 th point (500,1500,1750)	18 th point (500,750,1500)	
<u>DP – HR Reading</u>	4 bands	4 bands	81.071%	84.107%	15 th point (250,1500,1750)	5 th point (250,500,1750)	

3.3.2.2 Non Uniform Band Edges in 0 – 3000 Hz Frequency Range

For this study, the band edge frequency range is swept in between 0 – 3000 Hz frequency range with 250 Hz frequency increment. One hundred and sixty five different combinations of non-uniform energy bands edges were used in the 0 – 3000 Hz frequency range. This study is done with fixed number of bands for only one pairwise group which is Depressed – High Risk Suicidal pair (DP-HR). Four energy bands (PSD1, PSD2, PSD3, and PSD4) were analyzed in this study with using two classification methods (linear and quadratic). Table 73 shows the non-uniform band edges and the classification rates of 165 possible energy bands that are created with these edges.

Table 73: Non Uniform Band Edges Classification Results for the DP – HR Pair with 0 – 3000 Hz Band Range

	Non-Uniform Band Edges			Linear (0 -3000 Hz)				Quadratic(0-3000 Hz)			
				Male DP-HR	Male DP-HR	Female DP-HR	Female DP-HR	Male DP-HR	Male DP-HR	Female DP-HR	Female DP-HR
	X1	X2	X3	INT	RNB	INT	RNB	INT	RNB	INT	RNB
1	250	500	750	72.901	71.786	68.75	70.532	77.974	82.857	75.374	75.347
2	250	500	1000	77.017	74.643	71.835	69.973	78.032	75.893	76.896	75.905
3	250	500	1250	77.296	75.893	70.7	71.379	77.664	77.679	75.334	77.6
4	250	500	1500	78.032	75.536	67.308	69.684	77.105	79.464	73.838	77.6
5	250	500	1750	78.576	78.571	66.026	70.82	77.105	84.107	74.479	75.905
6	250	500	2000	78.664	78.571	63.702	70.532	78.767	82.321	73.384	76.753
7	250	500	2250	79.134	80.714	61.004	72.515	78.958	81.071	70.82	78.178
8	250	500	2500	80.061	74.107	60.27	72.515	78.59	75	70.246	72.535
9	250	500	2750	78.12	67.679	59.014	72.227	80.722	68.571	70.713	72.804
10	250	750	1000	75.635	76.429	67.601	74.249	75.826	76.786	72.796	76.791
11	250	750	1250	76.929	78.571	61.392	69.992	76.561	75.714	69.551	73.941
12	250	750	1500	79.046	77.679	56.343	68.008	77.399	79.464	69.431	71.668
13	250	750	1750	77.752	77.679	56.771	69.992	78.693	81.429	70.593	67.7
14	250	750	2000	79.223	75.536	53.472	68.856	80.163	81.786	75.187	72.804
15	250	750	2250	78.488	75.893	53.272	62.904	80.443	80.179	75.614	68.567
16	250	750	2500	78.017	77.321	53.953	58.359	77.752	77.143	74.626	68.856
17	250	750	2750	78.576	75.179	53.953	62.904	75.62	74.643	71.034	66.853
18	250	1000	1250	76.929	76.429	53.846	50.135	75.826	76.786	68.95	67.373
19	250	1000	1500	76.738	77.679	59.295	42.469	75.635	80.714	69.685	65.948
20	250	1000	1750	77.473	77.679	58.934	44.742	75.914	83.571	76.028	72.515
21	250	1000	2000	78.399	76.786	57.038	50.693	76.282	80.893	73.798	68.798
22	250	1000	2250	78.679	77.679	56.824	48.71	76.282	77.5	70.433	64.542
23	250	1000	2500	78.679	75.179	55.783	49.268	76.84	77.5	72.142	67.084
24	250	1000	2750	79.884	75.179	54.434	50.404	77.958	79.286	73.932	65.678
25	250	1250	1500	76.473	77.679	63.088	53.775	77.841	81.964	66.867	70.493
26	250	1250	1750	76.929	78.929	58.387	52.928	75.811	83.571	73.357	75.327
27	250	1250	2000	78.767	77.679	58.173	48.998	75.723	80.893	73.237	69.357
28	250	1250	2250	79.134	76.786	58.173	43.297	75.723	78.75	72.556	65.948
29	250	1250	2500	79.046	75.536	57.866	47.284	76.649	77.5	73.598	62.827
30	250	1250	2750	79.605	77.321	54.808	52.388	76.282	78.393	68.109	61.691
31	250	1500	1750	79.046	81.071	56.25	45.859	75.723	82.321	64.583	69.646
32	250	1500	2000	78.488	77.679	58.694	53.255	75.444	80.893	71.688	65.659
33	250	1500	2250	78.855	77.679	58.574	47.862	75.723	78.75	70.82	69.357
34	250	1500	2500	78.767	76.429	56.37	47.573	76.929	78.393	69.885	62.827
35	250	1500	2750	79.605	76.429	54.26	50.693	75.826	79.286	69.004	59.996
36	250	1750	2000	78.767	77.679	56.303	58.359	73.885	82.321	74.506	71.629
37	250	1750	2250	78.576	77.679	55.142	50.982	75.546	79.286	76.456	66.237
38	250	1750	2500	77.929	77.679	54.26	47.015	76.105	79.286	71.648	60.555
39	250	1750	2750	79.781	77.679	52.698	49.846	76.473	79.286	71.247	53.178
40	250	2000	2250	78.576	76.786	54.46	52.658	75.914	78.393	72.009	61.402

41	250	2000	2500	79.223	76.786	53.646	54.083	76.017	77.5	75.28	58.841
42	250	2000	2750	80.708	76.786	51.629	52.099	77.12	80.536	70.606	59.418
43	250	2250	2500	78.855	77.5	53.165	53.794	76.296	75.714	66.239	69.915
44	250	2250	2750	81.355	76.786	52.644	53.525	76.473	81.786	64.543	67.662
45	250	2500	2750	79.693	71.607	53.245	67.989	76.575	78.75	63.261	72.515
46	500	750	1000	75.914	68.75	64.476	73.69	79.237	80.357	65.518	73.979
47	500	750	1250	77.943	68.393	65.612	72.265	78.679	73.214	66.44	71.976
48	500	750	1500	79.046	69.643	62.62	69.992	80.987	71.429	65.745	75.077
49	500	750	1750	78.767	71.786	62.834	66.583	80.899	81.429	67.949	75.655
50	500	750	2000	78.488	72.679	63.448	70.281	81.266	79.643	68.657	76.502
51	500	750	2250	78.855	72.679	62.473	64.599	80.531	79.643	67.348	73.671
52	500	750	2500	78.752	72.679	62.139	63.733	79.237	77.5	66.707	75.636
53	500	750	2750	79.223	69.643	61.619	64.869	78.855	76.25	65.331	75.616
54	500	1000	1250	77.943	69.643	62.861	64.58	75.267	74.464	66.052	67.662
55	500	1000	1500	77.576	68.393	64.049	64.869	73.973	78.036	65.411	71.938
56	500	1000	1750	77.943	73.036	64.543	64.869	75.179	79.286	67.548	72.246
57	500	1000	2000	78.399	72.143	64.116	65.716	76.002	77.857	69.017	68.278
58	500	1000	2250	79.046	71.786	62.861	64.869	76.091	78.393	66.266	73.921
59	500	1000	2500	79.326	71.786	61.792	64.869	76.282	76.607	67.374	71.649
60	500	1000	2750	78.87	70.536	62.527	63.733	77.031	75.714	66.947	70.493
61	500	1250	1500	76.105	68.036	64.744	66.853	75.355	79.464	65.224	69.665
62	500	1250	1750	77.943	73.036	64.971	67.7	75.914	78.929	70.86	69.414
63	500	1250	2000	78.032	70.893	64.236	62.885	76.002	76.25	71.314	67.681
64	500	1250	2250	79.046	69.643	63.408	64.869	75.723	77.143	66.266	67.951
65	500	1250	2500	79.046	69.643	63.502	66.564	75.914	74.107	67.682	68.798
66	500	1250	2750	79.605	69.643	63.595	64.58	76.561	73.214	67.561	66.237
67	500	1500	1750	79.046	75.179	64.209	63.733	76.282	81.429	69.431	67.951
68	500	1500	2000	79.414	70.893	65.371	64.869	76.091	76.25	68.843	65.697
69	500	1500	2250	78.855	69.643	64.73	63.733	76.091	75	68.109	68.24
70	500	1500	2500	78.855	69.643	62.313	63.733	75.546	74.107	67.682	69.935
71	500	1500	2750	79.605	68.393	63.876	66.275	75.826	74.107	66.613	63.964
72	500	1750	2000	79.046	73.036	63.715	66.564	74.62	81.964	68.47	70.512
73	500	1750	2250	78.576	73.036	62.366	64.869	76.282	79.286	64.944	68.24
74	500	1750	2500	78.576	73.036	63.595	65.716	76.105	76.25	66.239	66.237
75	500	1750	2750	79.326	73.929	64.85	66.275	75.826	79.286	67.682	64.811
76	500	2000	2250	78.208	72.143	61.325	65.716	76.282	77.143	65.077	63.675
77	500	2000	2500	79.223	72.143	61.672	65.428	76.855	75.357	64.89	67.354
78	500	2000	2750	80.708	70.536	63.475	65.428	76.752	77.143	67.041	62.827
79	500	2250	2500	78.399	75	61.792	66.275	75.928	76.25	65.264	71.052
80	500	2250	2750	80.34	75.893	61.365	65.428	77.678	78.393	66.186	69.935
81	500	2500	2750	78.855	75.536	59.615	68.837	77.046	77.5	65.264	76.194
82	750	1000	1250	77.208	69.286	68.51	71.995	74.429	72.321	70.219	73.112
83	750	1000	1500	77.12	69.286	68.443	71.148	74.797	71.071	69.324	71.706
84	750	1000	1750	77.576	75.179	69.765	70.859	74.238	76.964	74.8	73.69
85	750	1000	2000	77.664	73.036	68.269	72.843	74.047	74.286	73.21	72.843
86	750	1000	2250	78.679	75.179	67.535	72.843	75.62	71.607	70.606	73.979

87	750	1000	2500	79.046	69.286	68.483	71.706	75.532	70.893	70.459	70.859
88	750	1000	2750	79.237	69.286	67.722	77.928	75.914	66.786	69.698	72.843
89	750	1250	1500	76.105	75.179	67.094	70.281	78.664	78.571	71.461	67.45
90	750	1250	1750	77.296	78.929	66.066	70.859	75.164	75.179	73.21	68.875
91	750	1250	2000	78.032	77.679	66.159	73.401	76.179	73.75	71.554	68.875
92	750	1250	2250	78.488	76.786	67.842	72.554	76.091	74.107	70.793	70.281
93	750	1250	2500	79.134	75.536	68.456	72.554	76.649	72.5	70.032	71.976
94	750	1250	2750	79.237	72.679	67.601	72.265	76.649	69.643	69.364	71.418
95	750	1500	1750	78.679	77.679	55.702	68.008	75.253	78.571	64.543	68.297
96	750	1500	2000	79.414	77.679	60.016	69.723	77.105	75	69.912	69.723
97	750	1500	2250	78.855	76.786	65.946	66.025	77.017	74.107	70.126	66.872
98	750	1500	2500	78.767	75.536	66.96	69.145	76.649	71.25	69.578	68.008
99	750	1500	2750	79.605	76.429	64.209	68.008	77.767	72.143	67.415	65.177
100	750	1750	2000	78.767	76.429	59.482	67.161	74.899	79.286	70.059	68.875
101	750	1750	2250	78.576	77.679	62.967	66.602	76.473	76.25	69.017	64.908
102	750	1750	2500	78.576	75.179	60.71	64.888	76.105	75	69.151	69.992
103	750	1750	2750	79.972	75.179	58.787	64.33	77.781	76.786	69.217	69.145
104	750	2000	2250	78.855	77.679	59.669	69.145	77.487	76.25	70.299	67.72
105	750	2000	2500	78.943	76.786	57.746	66.602	76.296	74.464	69.177	71.687
106	750	2000	2750	80.428	75.536	58.427	69.723	78.428	75.893	66.92	73.382
107	750	2250	2500	78.855	73.75	57.973	68.586	77.502	76.607	66.827	71.418
108	750	2250	2750	80.428	74.643	59.749	66.314	80.648	74.107	66.466	73.112
109	750	2500	2750	78.576	73.393	52.564	65.139	79.899	74.107	65.879	66.044
110	1000	1250	1500	76.561	70.536	61.258	59.495	79.502	75.536	60.964	61.171
111	1000	1250	1750	76.649	75.179	48.024	60.901	75.532	79.821	71.474	60.632
112	1000	1250	2000	78.488	72.679	47.716	51.541	76.179	75.357	71.421	65.986
113	1000	1250	2250	79.046	73.036	49.826	60.612	76.458	75.357	67.281	62.018
114	1000	1250	2500	79.046	70.536	49.092	61.46	75.532	73.75	70.553	60.593
115	1000	1250	2750	80.163	69.286	51.696	51.541	76.84	75	69.738	53.486
116	1000	1500	1750	77.194	76.964	51.936	45.281	75.9	78.571	60.15	67.681
117	1000	1500	2000	77.561	74.286	52.885	52.947	74.885	75.893	65.545	61.441
118	1000	1500	2250	78.12	74.643	53.405	48.401	75.532	74.643	67.468	61.441
119	1000	1500	2500	78.399	70.179	53.926	46.129	76.738	74.643	69.124	61.152
120	1000	1500	2750	78.693	69.286	54.26	52.388	77.767	74.643	67.722	54.353
121	1000	1750	2000	78.12	75.179	52.484	63.444	75.164	80.179	68.723	60.959
122	1000	1750	2250	76.458	77.679	51.349	48.979	75.62	79.464	70.86	59.823
123	1000	1750	2500	78.679	75.179	50.067	48.401	76.37	80.179	68.483	60.921
124	1000	1750	2750	78.693	75.179	47.93	53.525	78.046	78.571	66.346	65.447
125	1000	2000	2250	77.473	76.429	51.656	55.2	76.091	77.143	72.449	65.119
126	1000	2000	2500	78.399	75.536	48.17	48.421	76.37	76.607	72.129	58.301
127	1000	2000	2750	79.149	75.536	49.092	54.353	76.84	77.5	67.228	63.694
128	1000	2250	2500	79.046	77.679	52.15	53.236	76.561	79.643	68.83	68.817
129	1000	2250	2750	79.428	75.536	51.723	52.099	78.414	79.643	67.081	65.716
130	1000	2500	2750	79.34	70.179	51.629	64.869	76.664	79.286	66.226	68.008
131	1250	1500	1750	76.738	78.214	62.727	58.59	76.649	80.714	59.629	68.201
132	1250	1500	2000	77.017	73.393	62.513	54.372	76.267	77.679	65.425	59.457

133	1250	1500	2250	77.385	73.393	60.377	51.522	76.165	76.429	67.775	57.762
134	1250	1500	2500	77.664	75.536	59.856	54.334	75.811	76.429	68.483	53.486
135	1250	1500	2750	79.531	76.429	60.59	53.794	76.649	75.179	68.056	59.457
136	1250	1750	2000	78.399	78.571	52.39	56.934	74.62	80.179	66.413	65.216
137	1250	1750	2250	78.311	77.321	50.921	48.979	75.164	79.286	67.561	60.67
138	1250	1750	2500	78.032	78.571	49.947	56.606	75.076	78.036	64.85	64.31
139	1250	1750	2750	77.678	77.321	50.254	55.22	74.988	79.286	64.73	64.58
140	1250	2000	2250	78.488	77.679	53.005	53.775	75.546	75	70.967	56.298
141	1250	2000	2500	79.605	76.786	48.972	52.947	75.179	75.357	70.887	60.535
142	1250	2000	2750	79.619	77.679	47.623	53.794	75.355	76.25	65.184	59.418
143	1250	2250	2500	79.046	76.786	57.532	52.388	74.899	78.393	71.595	66.814
144	1250	2250	2750	79.708	75.893	57.105	50.963	76.193	77.143	67.481	65.119
145	1250	2500	2750	79.899	75.536	54.901	63.733	76.752	77.143	65.892	64.002
146	1500	1750	2000	78.767	79.464	51.162	54.372	75.164	80.179	59.696	56.645
147	1500	1750	2250	79.134	79.464	51.202	45.859	76.179	77.143	61.432	58.59
148	1500	1750	2500	78.767	79.464	51.91	46.418	76.929	77.143	59.842	57.704
149	1500	1750	2750	79.237	78.214	48.945	49.557	75.635	78.393	60.764	61.113
150	1500	2000	2250	78.855	77.679	54.207	51.541	75.179	75.893	69.485	53.717
151	1500	2000	2500	78.855	76.786	54.06	60.882	74.899	75.357	67.014	62.23
152	1500	2000	2750	79.326	77.679	48.518	57.492	75.076	75.893	63.876	59.688
153	1500	2250	2500	78.855	77.679	55.435	52.966	74.708	80.179	65.825	65.408
154	1500	2250	2750	79.046	76.786	54.327	56.626	75.444	77.143	67.481	69.087
155	1500	2500	2750	80.075	75.536	55.248	64.31	76.002	76.25	66.44	65.139
156	1750	2000	2250	77.561	78.929	56.29	62.866	72.973	81.429	69.057	62.519
157	1750	2000	2500	78.208	75.179	51.883	58.34	73.987	80.179	69.004	74.441
158	1750	2000	2750	79.326	75.179	47.569	63.444	73.885	80.893	67.321	64.253
159	1750	2250	2500	78.208	77.679	51.936	54.372	74.811	83.214	71.608	67.681
160	1750	2250	2750	79.605	77.679	52.885	59.746	74.988	80.536	66.613	67.681
161	1750	2500	2750	79.796	75.179	50.467	64.31	75.267	78.75	66.653	69.106
162	2000	2250	2500	78.943	75.893	52.818	51.81	75.458	82.5	71.234	67.662
163	2000	2250	2750	78.958	75.536	52.698	55.22	76.561	81.429	69.725	63.424
164	2000	2500	2750	80.163	76.786	51.696	70.84	76.664	82.321	65.091	69.106
165	2250	2500	2750	80.075	76.25	57.412	64.002	77.693	79.643	64.543	72.496

Table 74 shows the averages and some other statistics of the classification results for the DP- HR pairwise group for both the female and the male patients with two different classification methods of the linear classification and the quadratic classification for the 0-3000 Hz frequency band range.

Table 74: Non Uniform Band Edges Classification Averages for the DP – HR Pair with 0 – 3000 Hz Band Range

DP- HR PAIR	Linear (0 -3000 Hz)				Quadratic(0-3000 Hz)			
	Male INT	Male RNB	Female INT	Female RNB	Male INT	Male RNB	Female INT	Female RNB
Average	78.588	74.919	58.379	60.720	76.494	77.504	68.752	67.266
Std. Dev	1.088	3.071	6.034	8.551	1.523	3.081	3.455	5.555
Min	72.901	67.679	47.569	42.469	72.973	66.786	59.629	53.178
Max	81.355	81.071	71.835	77.928	81.266	84.107	76.896	78.178

3.3.2.2.1 Female DP – HR Pairwise Group during the Interview Session

The following figures show the classification results for the male DP-HR pairwise group during the interview session.

3.3.2.2.1.1 Linear Classification Results

The figure below, Figure 225, shows the classification rates using the linear the classifier. According to the linear classifier, the maximum classification rate found as 71.835% for the 2nd data point (250, 500, 1000) which means the following PSD combination(**PSD 1:** 0 -250 Hz, **PSD 2:** 250-500 Hz, **PSD 3:** 500-1000 Hz, **PSD 4:**1000-3000 Hz).

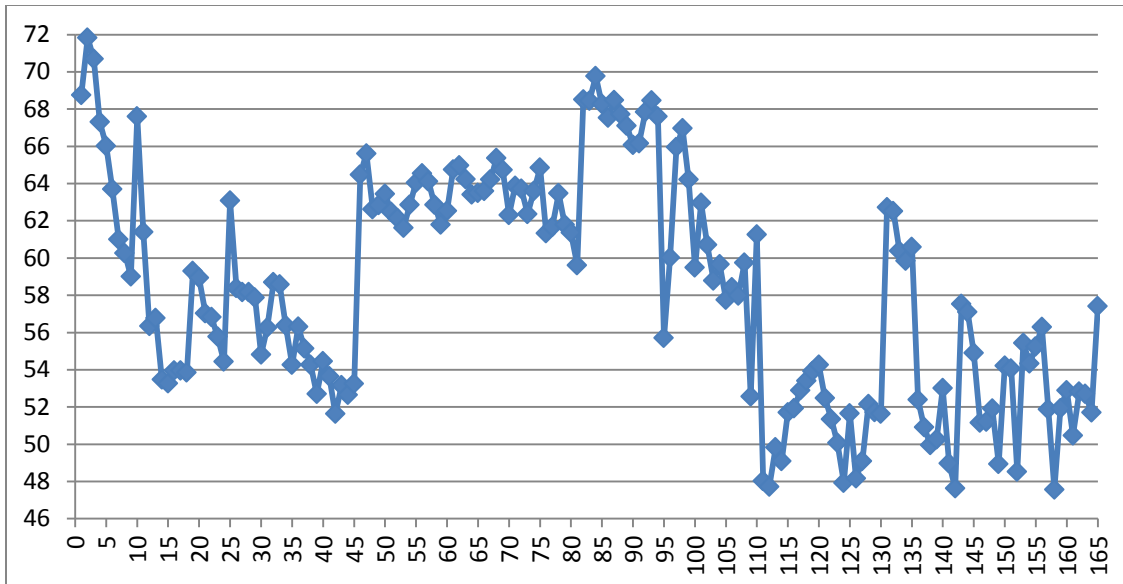

Figure 225: Non Uniform Band Edges Classification Results for the Female DP – HR Interview with the 0 – 3000 Hz Band Range with the Linear Classifier

The following five figures (Figure 226, Figure 227, Figure 228, Figure 229, and Figure 230) show the zoomed in versions of the graph of the Figure 225. These graphs show only 33 points.

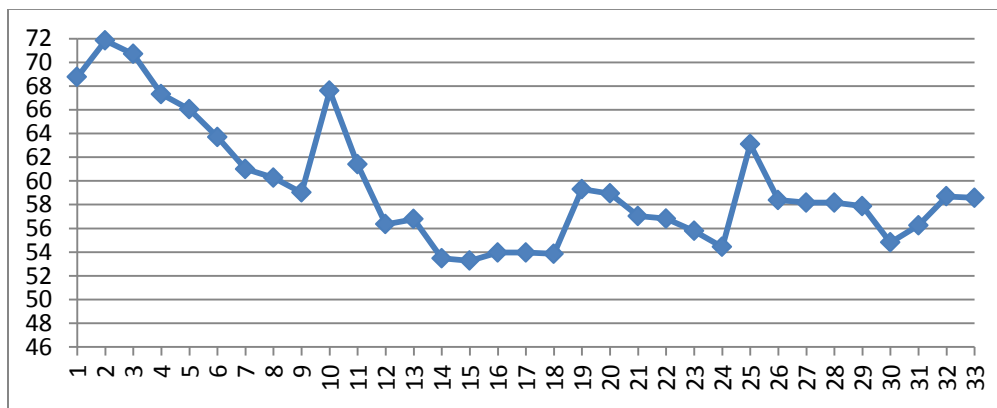

Figure 226: Zoom In Graph between Points 1 – 33 (of Figure 225)

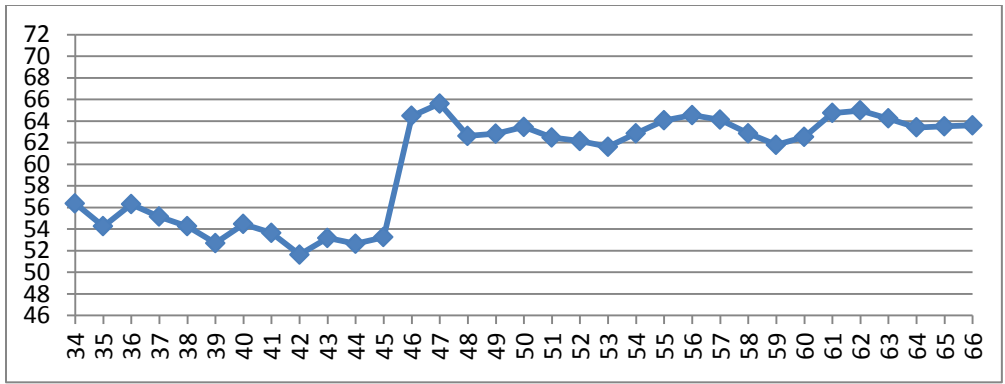

Figure 227: Zoom In Graph between Points 34 – 66 (of Figure 225)

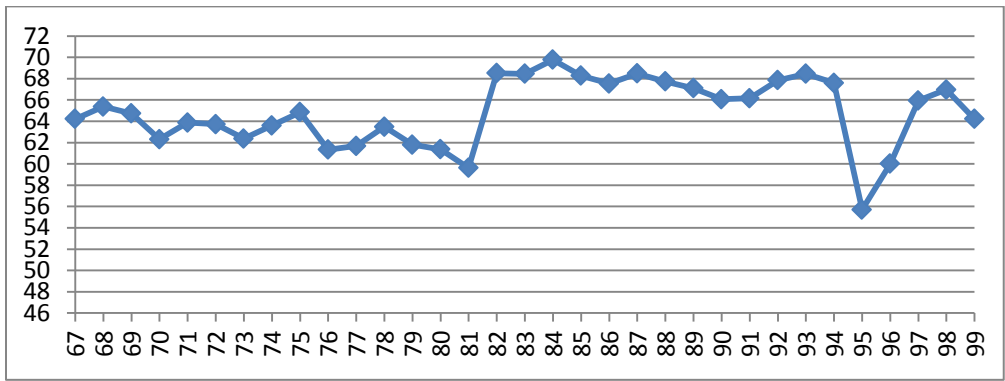

Figure 228: Zoom In Graph between Points 67 – 99 (of Figure 225)

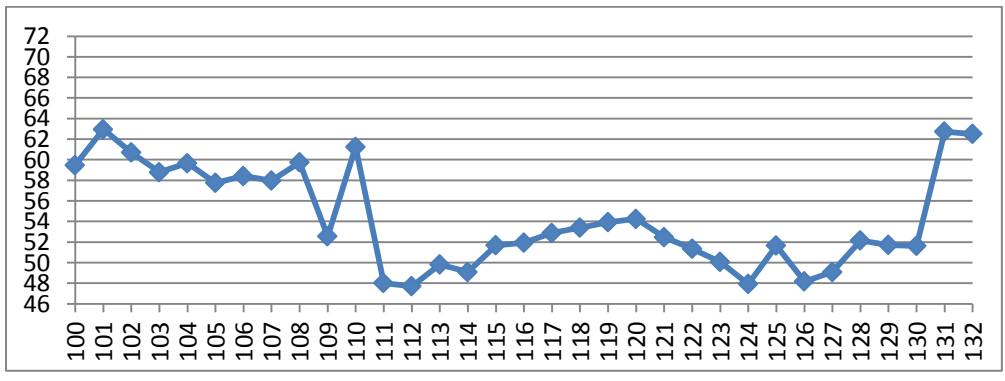

Figure 229: Zoom In Graph between Points 100 – 132 (of Figure 225)

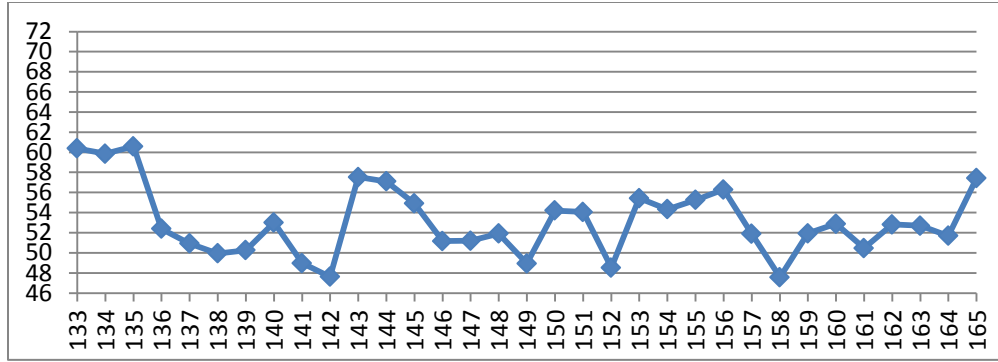

Figure 230: Zoom In Graph between Points 133 – 165 (of Figure 225)

3.3.2.2.1.2 Quadratic Classification Results

Figure 231 shows the classification rates using the quadratic classifier for the female DP-HR pairwise group during the interview session. According to the quadratic classifier, the maximum classification rate found as 76.896% for the 2nd data point (250, 500, 1000) which means the following PSD combination(**PSD 1:** 0 -250 Hz, **PSD 2:** 250-500 Hz, **PSD 3:** 500-1000 Hz, **PSD 4:**1000-3000 Hz).

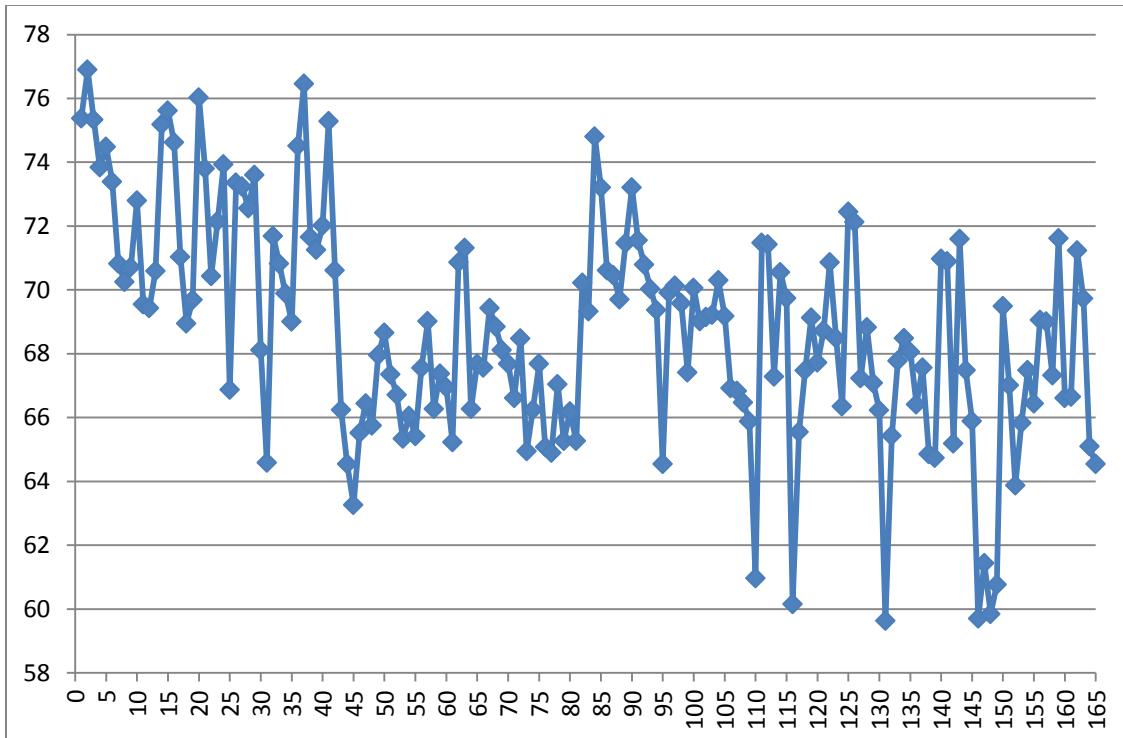

Figure 231: Non Uniform Band Edges Classification Results for the Female DP – HR Interview with the 0 – 3000 Hz Band Range with the Quadratic Classifier

The following five figures (Figure 232, Figure 233, Figure 234, Figure 235, and Figure 236) show the zoomed in versions of the graph of the Figure 231. These graphs show only 33 points.

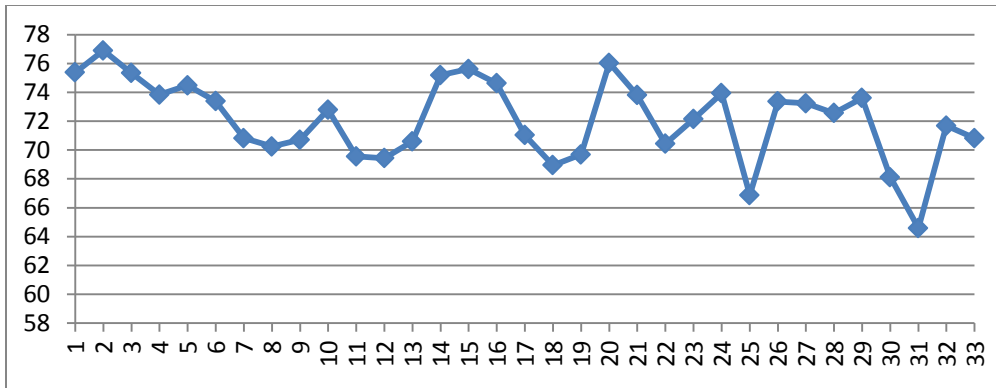

Figure 232: Zoom In Graph between Points 1 – 33 (Female DP – HR Interview between 0 – 3000 Hz Band Range with Quadratic Classifier)

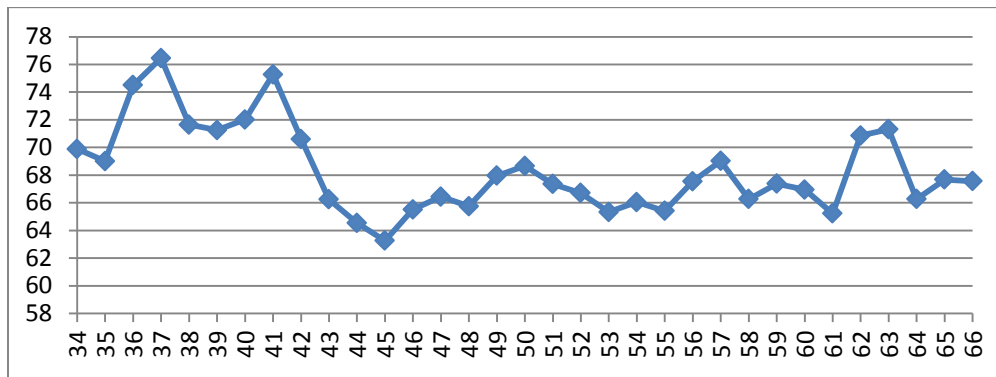

Figure 233: Zoom In Graph between Points 34 – 66 (Female DP – HR Interview between 0 – 3000 Hz Band Range with Quadratic Classifier)

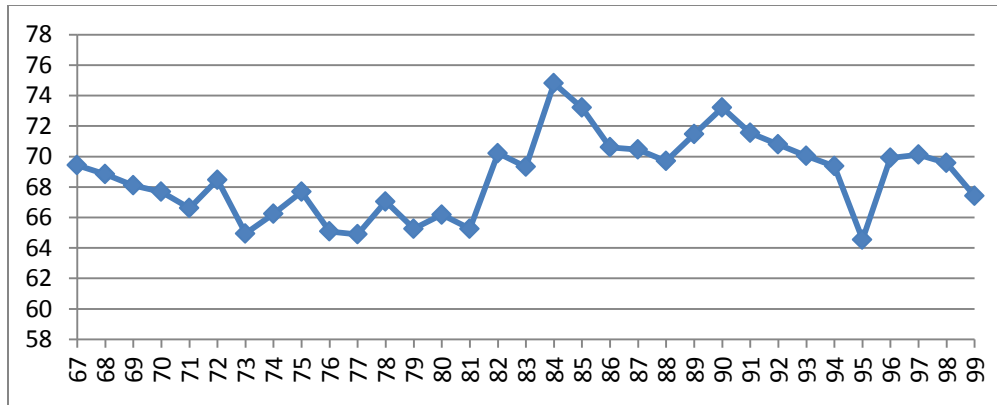

Figure 234: Zoom In Graph between Points 67 – 99 (Female DP – HR Interview between 0 – 3000 Hz Band Range with Quadratic Classifier)

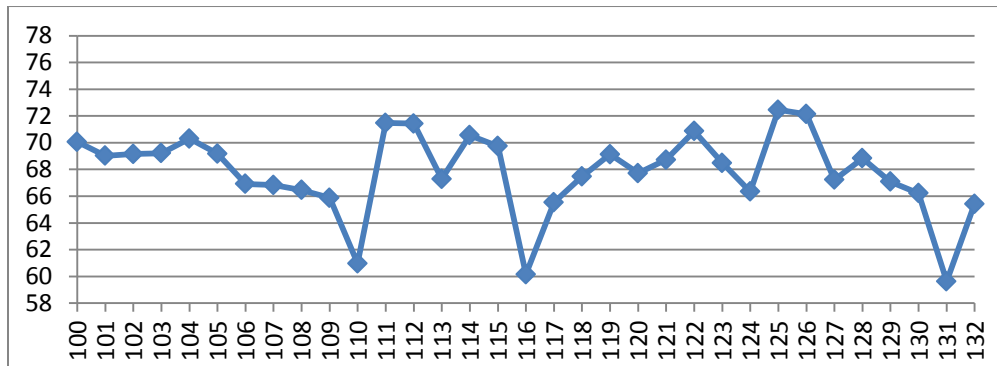

Figure 235: Zoom In Graph between Points 100 – 132 (Female DP – HR Interview between 0 – 3000 Hz Band Range with Quadratic Classifier)

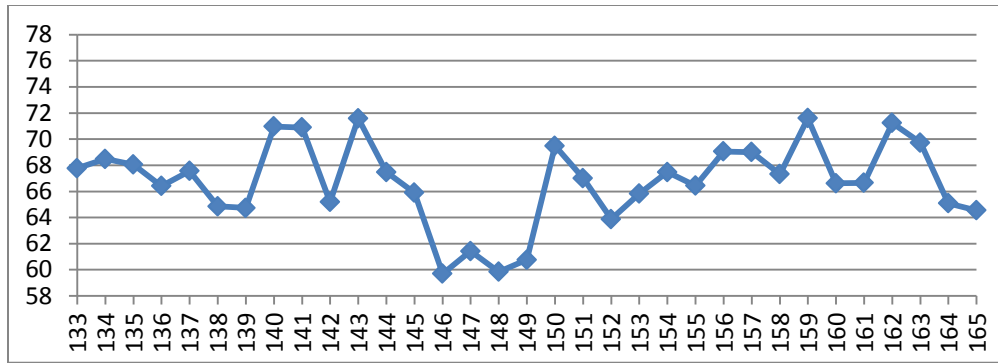

Figure 236: Zoom In Graph between Points 133 – 165 (Female DP – HR Interview between 0 – 3000 Hz Band Range with Quadratic Classifier)

3.3.2.2.2 Female DP – HR Pairwise Group during the Reading Session

The following figures show the classification results for the female DP-HR pairwise group during the reading session.

3.3.2.2.2.1 Linear Classification Results

Figure 237 shows the classification rates using the linear classifier. According to the linear classifier, the maximum classification rate found as 77.928% for the 88th data point (750, 1000, 2750) which means the following PSD combination(**PSD 1:** 0 -750 Hz, **PSD 2:** 750-1000 Hz, **PSD 3:** 1000-2750 Hz, **PSD 4:**2750-3000 Hz).

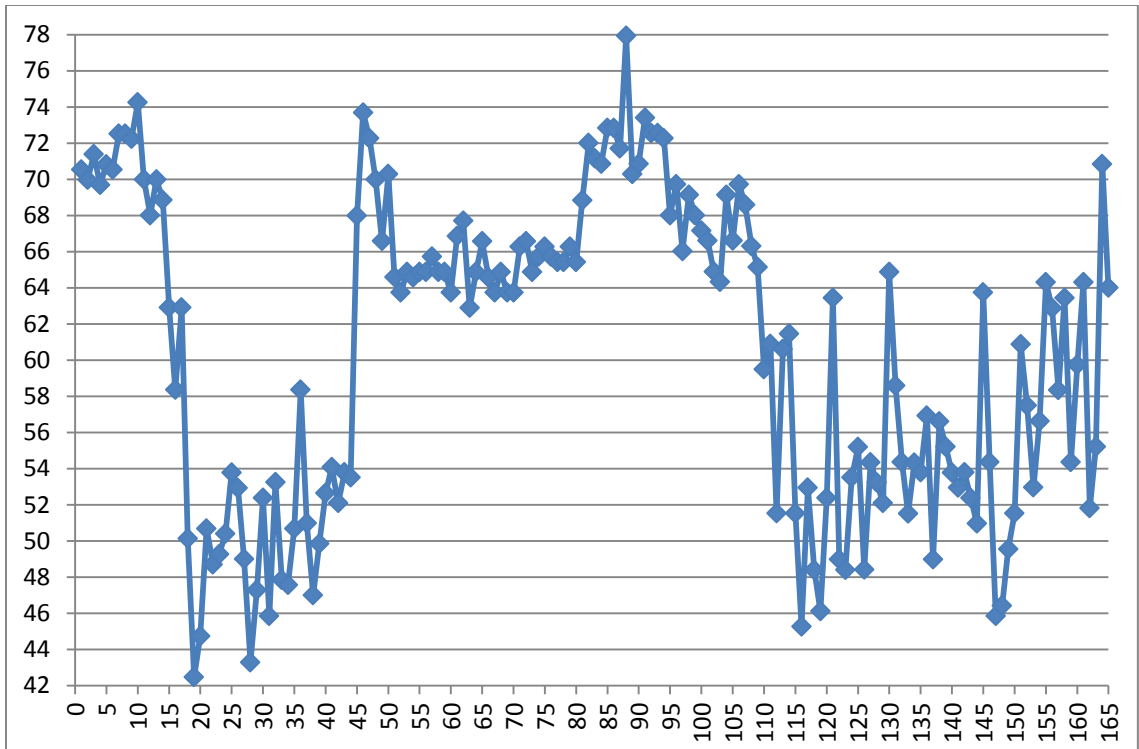

Figure 237: Non Uniform Band Edges Classification Results for the Female DP – HR Reading with the 0 – 3000 Hz Band Range with the Linear Classifier

The following five figures (Figure 238, Figure 239, Figure 240, Figure 241, and Figure 242) show the zoomed in versions of the graph of the Figure 237. These graphs show only 33 points.

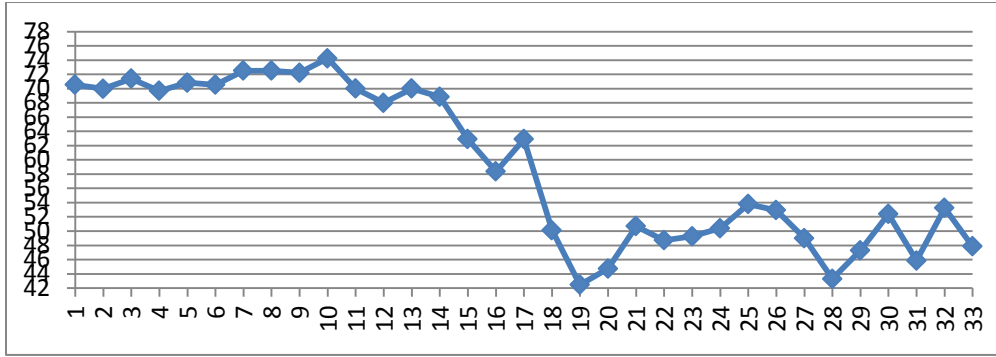

Figure 238: Zoom In Graph between Points 1 – 33 (Female DP – HR Reading between 0 – 3000 Hz Band Range with Linear Classifier)

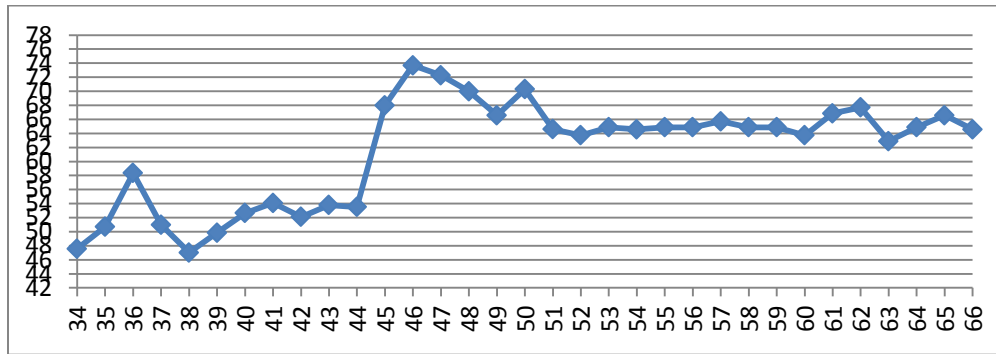

Figure 239: Zoom In Graph between Points 34 – 66 (Female DP – HR Reading between 0 – 3000 Hz Band Range with Linear Classifier)

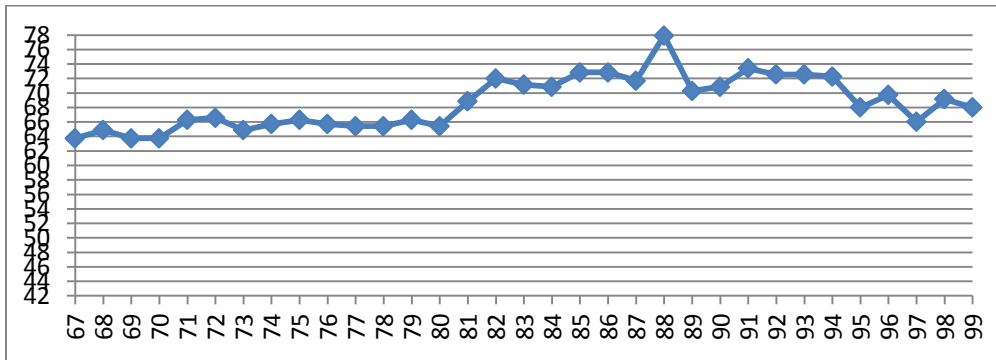

Figure 240: Zoom In Graph between Points 67 – 99 (Female DP – HR Reading between 0 – 3000 Hz Band Range with Linear Classifier)

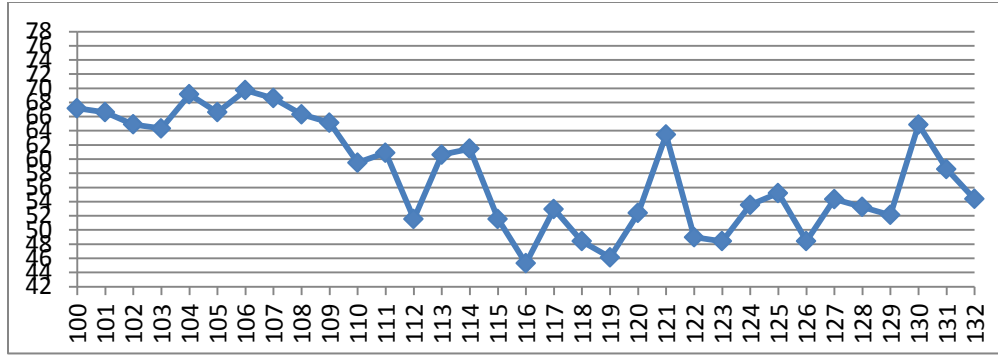

Figure 241: Zoom In Graph between Points 100 – 132 (Female DP – HR Reading between 0 – 3000 Hz Band Range with Linear Classifier)

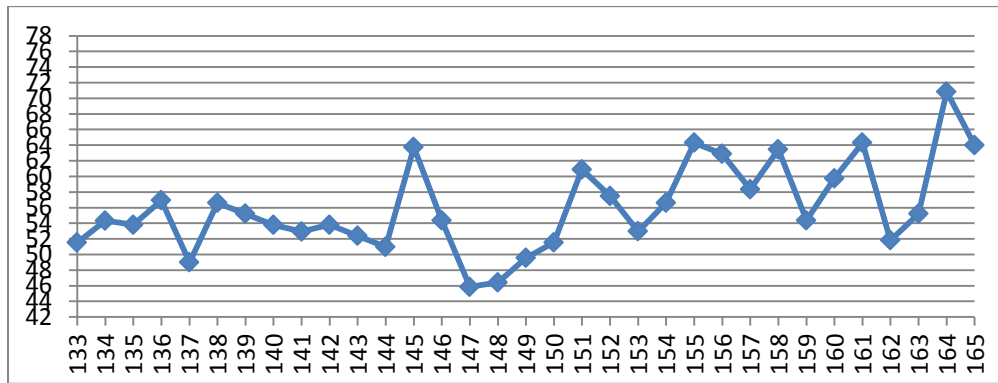

Figure 242: Zoom In Graph between Points 133 – 165 (Female DP – HR Reading between 0 – 3000 Hz Band Range with Linear Classifier)

3.3.2.2.2 Quadratic Classification Results

Figure 243 shows the classification rates using the quadratic classifier for the female DP-HR pairwise group during the reading session. According to the quadratic classifier, the maximum classification rate found as 78.178% for the 7th data point (250, 500, 2250) which means the following PSD combination(**PSD 1:** 0 -250 Hz, **PSD 2:** 250-500 Hz, **PSD 3:** 500-2250 Hz, **PSD 4:**2250-3000 Hz).

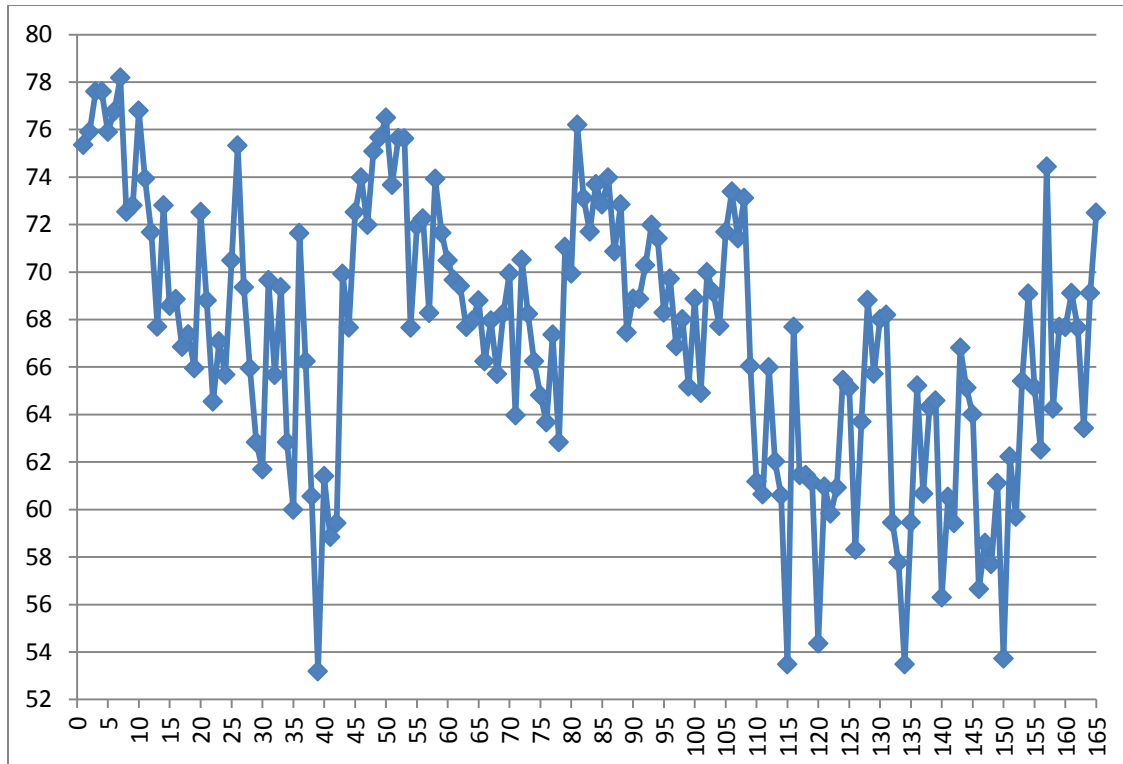

Figure 243: Non Uniform Band Edges Classification Results for the Female DP – HR Reading with the 0 – 3000 Hz Band Range with the Quadratic Classifier

The following five figures (Figure 244, Figure 245, Figure 246, Figure 247, and Figure 248) show the zoomed in versions of the graph of the Figure 243. These graphs show only 33 points.

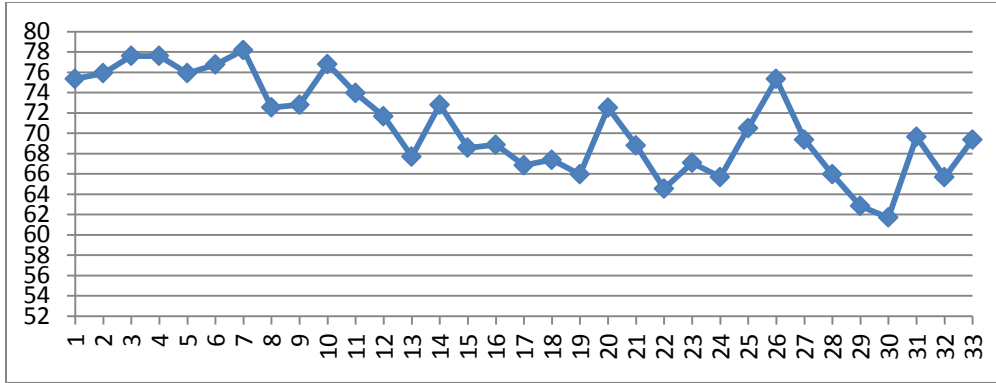

Figure 244: Zoom In Graph between Points 1 – 33 (Female DP – HR Reading between 0 – 3000 Hz Band Range with Quadratic Classifier)

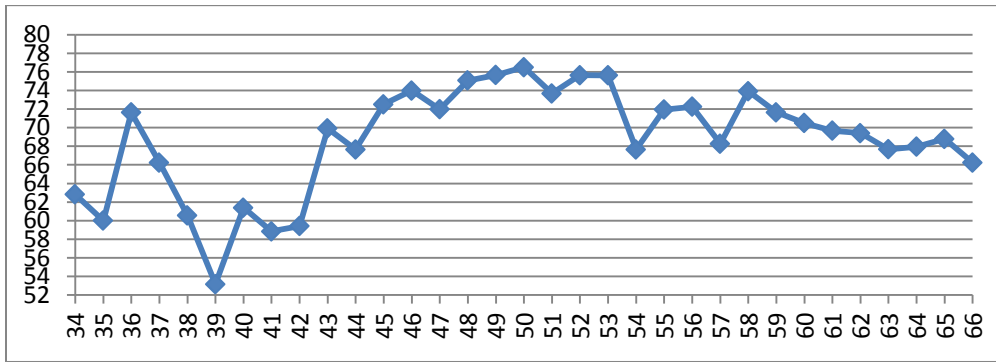

Figure 245: Zoom In Graph between Points 34 – 66 (Female DP – HR Reading between 0 – 3000 Hz Band Range with Quadratic Classifier)

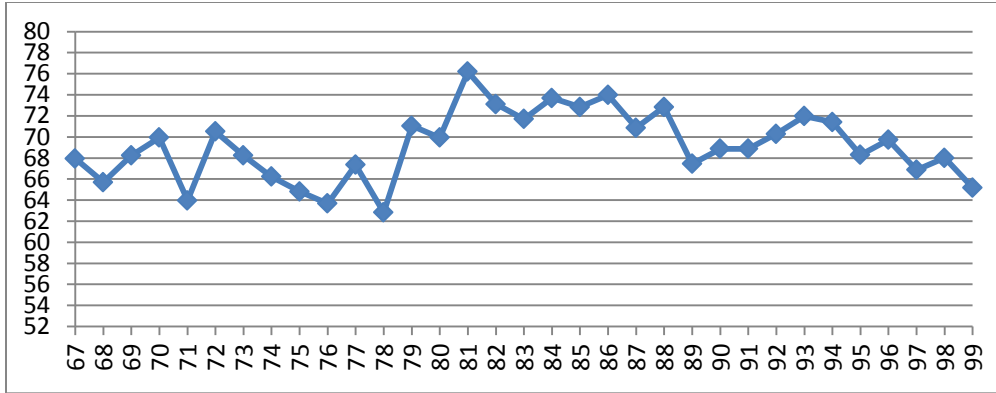

Figure 246: Zoom In Graph between Points 67 – 99 (Female DP – HR Reading between 0 – 3000 Hz Band Range with Quadratic Classifier)

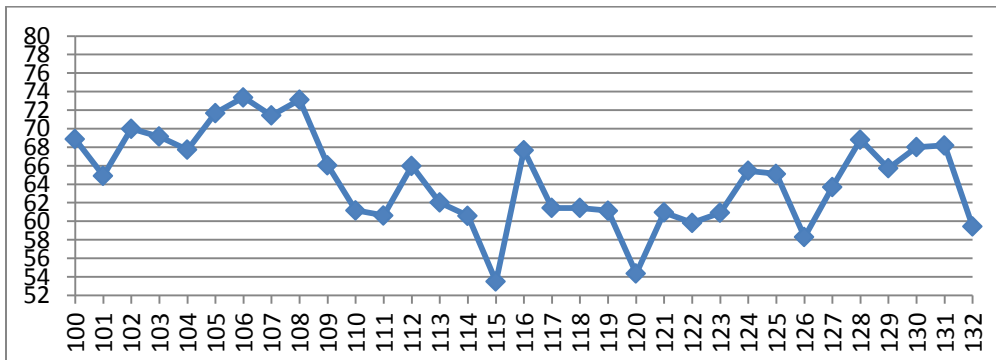

Figure 247: Zoom In Graph between Points 100 – 132 (Female DP – HR Reading between 0 – 3000 Hz Band Range with Quadratic Classifier)

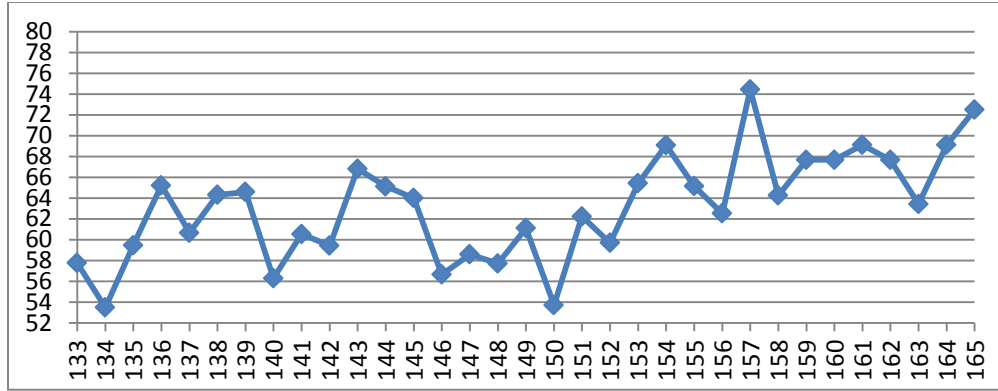

Figure 248: Zoom In Graph between Points 133 – 165 (Female DP – HR Reading between 0 – 3000 Hz Band Range with Quadratic Classifier)

3.3.2.2.3 Male DP – HR Pairwise Group during the Interview Session

The following figures show the classification results for the male DP-HR pairwise group during the interview session.

3.3.2.2.3.1 Linear Classification Results

Figure 214 shows the classification rates using the linear classifier. According to the linear classifier, the maximum classification rate found as 81.355 % for the 44th data point (250, 2250, 2750) which means the following PSD combination(**PSD 1:** 0 -250 Hz, **PSD 2:** 250-2250 Hz, **PSD 3:** 2250-2750 Hz, **PSD 4:**2750-3000 Hz).

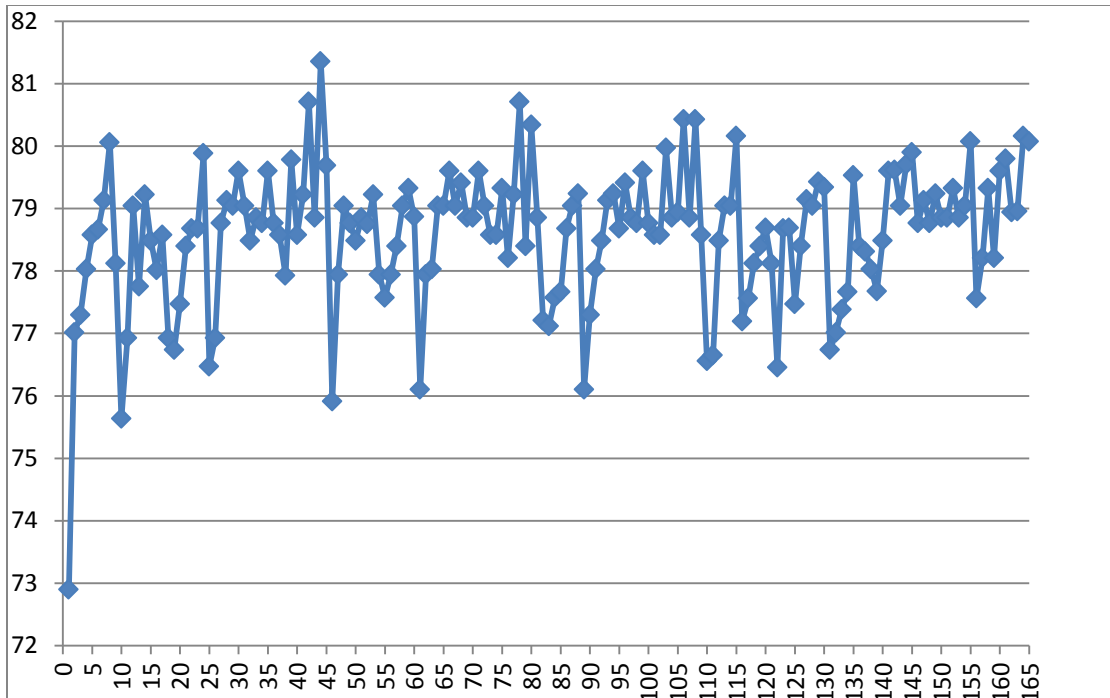

Figure 249: Non Uniform Band Edges Classification Results for the Male DP – HR Interview with the 0 – 3000 Hz Band Range with the Linear Classifier

The following five figures (Figure 250, Figure 251, Figure 252, Figure 253, and Figure 254) show the zoomed in versions of the graph of the Figure 249. These graphs show only 33 points.

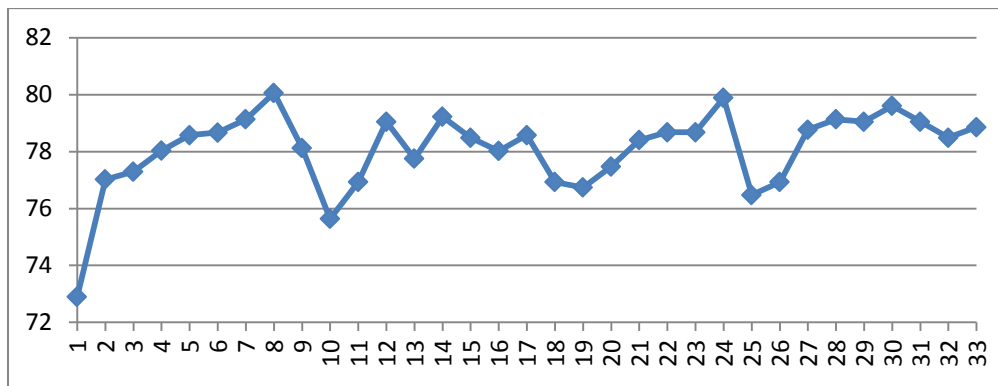

Figure 250: Zoom In Graph between Points 1 – 33 (Male DP – HR Interview between 0 – 3000 Hz Band Range with Linear Classifier)

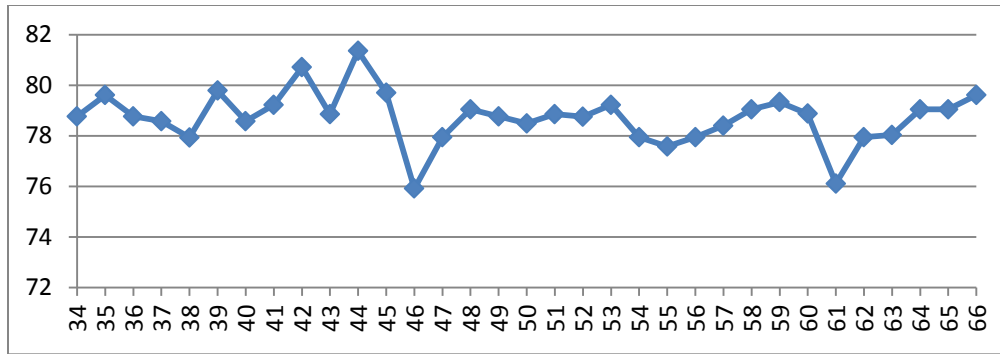

Figure 251: Zoom In Graph between Points 34 – 66 (Male DP – HR Interview between 0 – 3000 Hz Band Range with Linear Classifier)

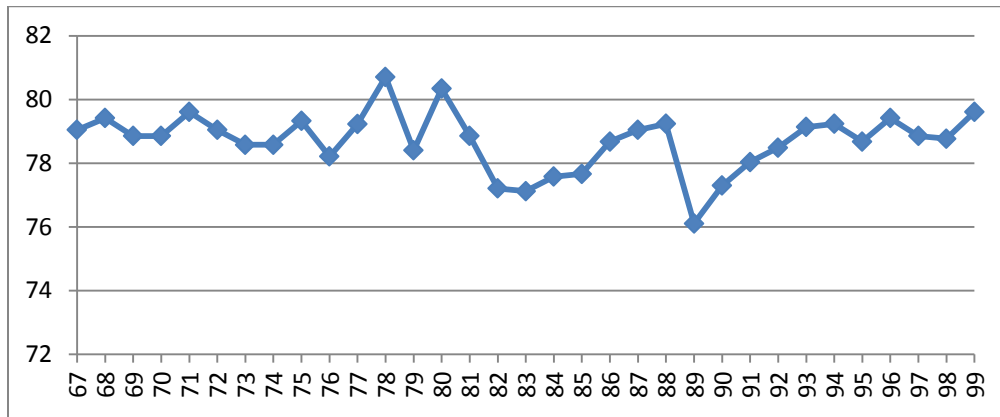

Figure 252: Zoom In Graph between Points 67 – 99 (Male DP – HR Interview between 0 – 3000 Hz Band Range with Linear Classifier)

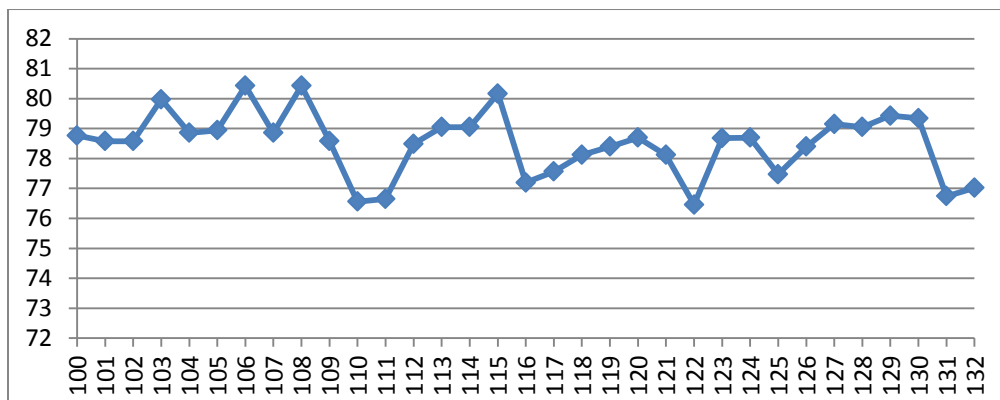

Figure 253: Zoom In Graph between Points 100 – 132 (Male DP – HR Interview between 0 – 3000 Hz Band Range with Linear Classifier)

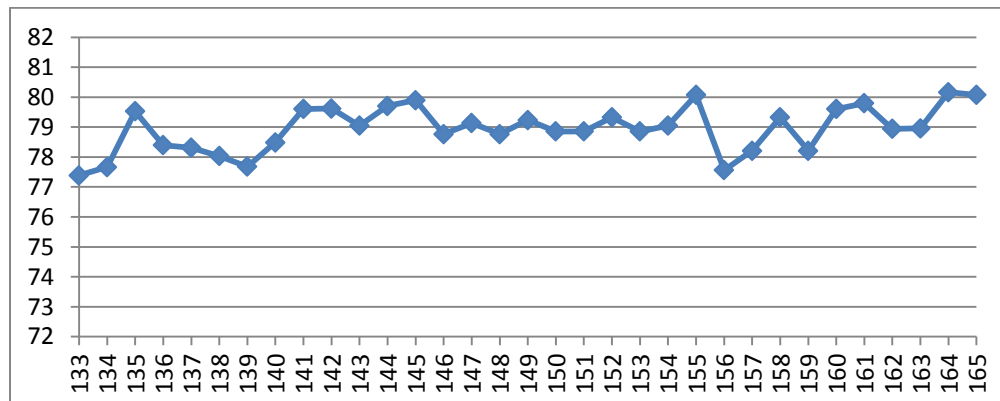

Figure 254: Zoom In Graph between Points 133 – 165 (Male DP – HR Interview between 0 – 3000 Hz Band Range with Linear Classifier)

3.3.2.2.3.2 Quadratic Classification Results

Figure 255 shows the classification rates using the quadratic classifier for the male DP-HR pairwise group during the interview session. According to the quadratic classifier, the maximum classification rate found as 81.266 % for the 50th data point (500, 750, 2000) which means the following PSD combination(**PSD 1:** 0 -500 Hz, **PSD 2:** 500-750 Hz, **PSD 3:** 750-2000 Hz, **PSD 4:**2000-3000 Hz).

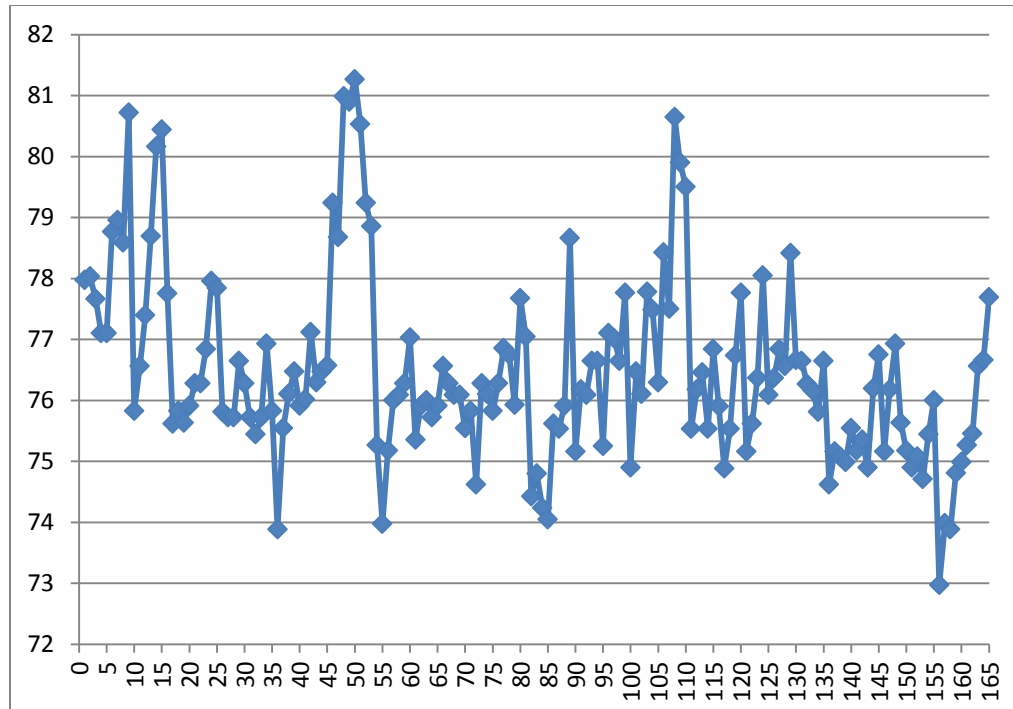

Figure 255: Non Uniform Band Edges Classification Results for the Male DP – HR Interview with the 0 – 3000 Hz Band Range with the Quadratic Classifier

The following five figures (Figure 256, Figure 257, Figure 258, Figure 259, and Figure 260) show the zoomed in versions of the graph of the Figure 220. These graphs show only 33 points.

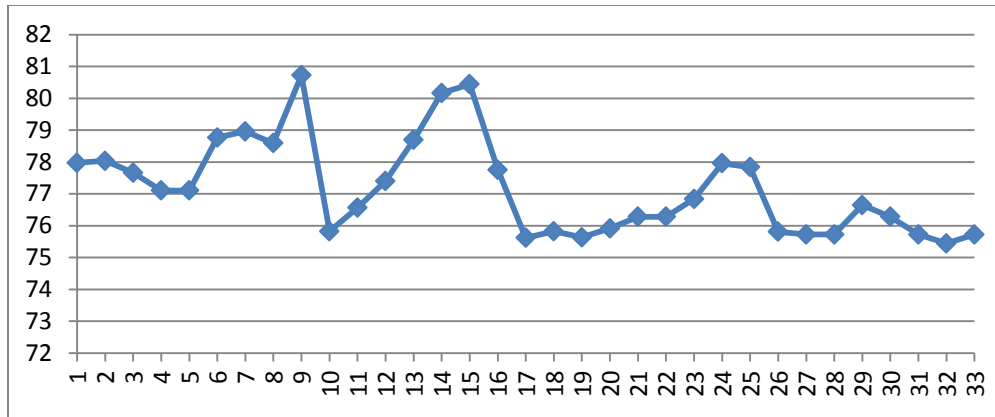

Figure 256: Zoom In Graph between Points 1 – 33 (Male DP – HR Interview between 0 – 3000 Hz Band Range with Quadratic Classifier)

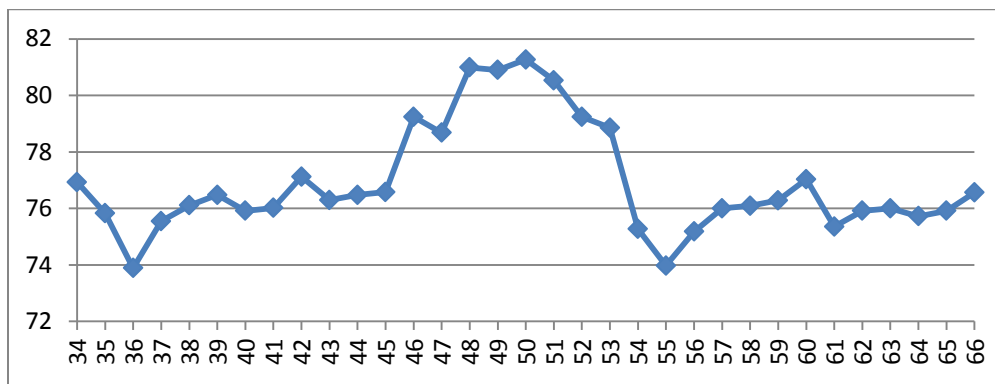

Figure 257: Zoom In Graph between Points 34 – 66 (Male DP – HR Interview between 0 – 3000 Hz Band Range with Quadratic Classifier)

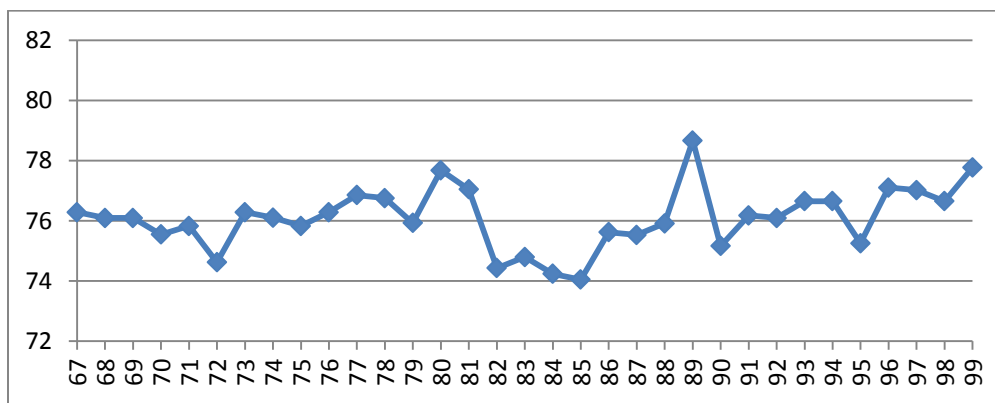

Figure 258: Zoom In Graph between Points 67 – 99 (Male DP – HR Interview between 0 – 3000 Hz Band Range with Quadratic Classifier)

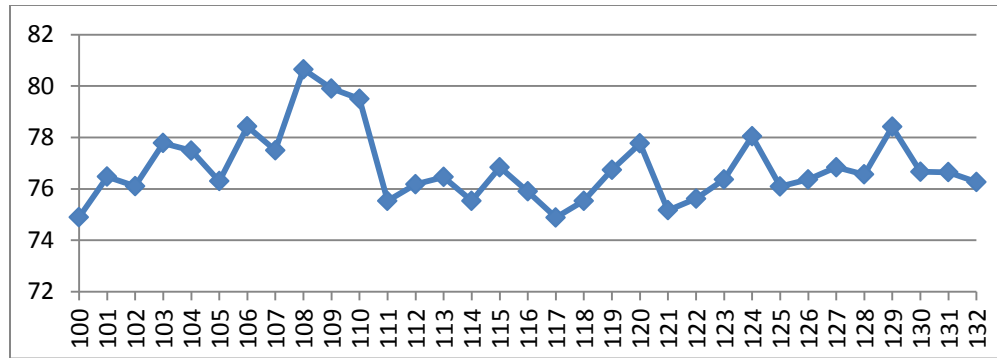

Figure 259: Zoom In Graph between Points 100 – 132 (Male DP – HR Interview between 0 – 3000 Hz Band Range with Quadratic Classifier)

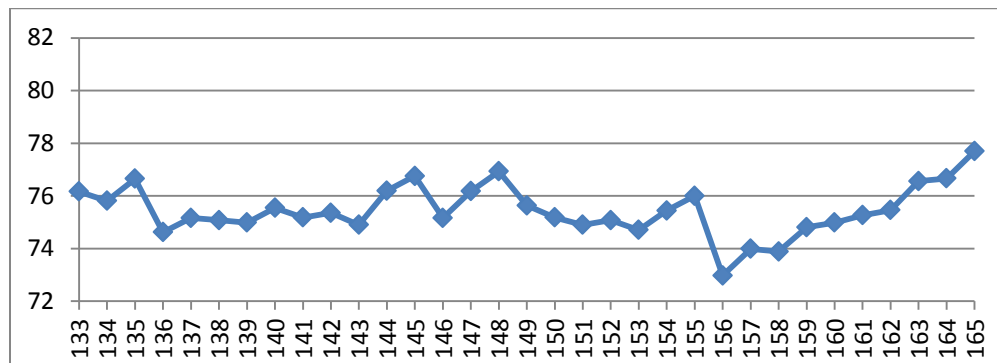

Figure 260: Zoom In Graph between Points 133 – 165 (Male DP – HR Interview between 0 – 3000 Hz Band Range with Quadratic Classifier)

3.3.2.2.4 Male DP – HR Pairwise Group during the Reading Session

The following figures show the classification results for the male DP-HR pairwise group during the reading session.

3.3.2.2.4.1 Linear Classification Results

Figure 261 shows the classification rates using the linear classifier. According to the linear classifier, the maximum classification rate found as 81.071% for the 31th data

point (250, 1500, 1750) which means the following PSD combination(**PSD 1:** 0 -250 Hz, **PSD 2:** 250-1500 Hz, **PSD 3:** 1500-1750 Hz, **PSD 4:**1750-3000 Hz).

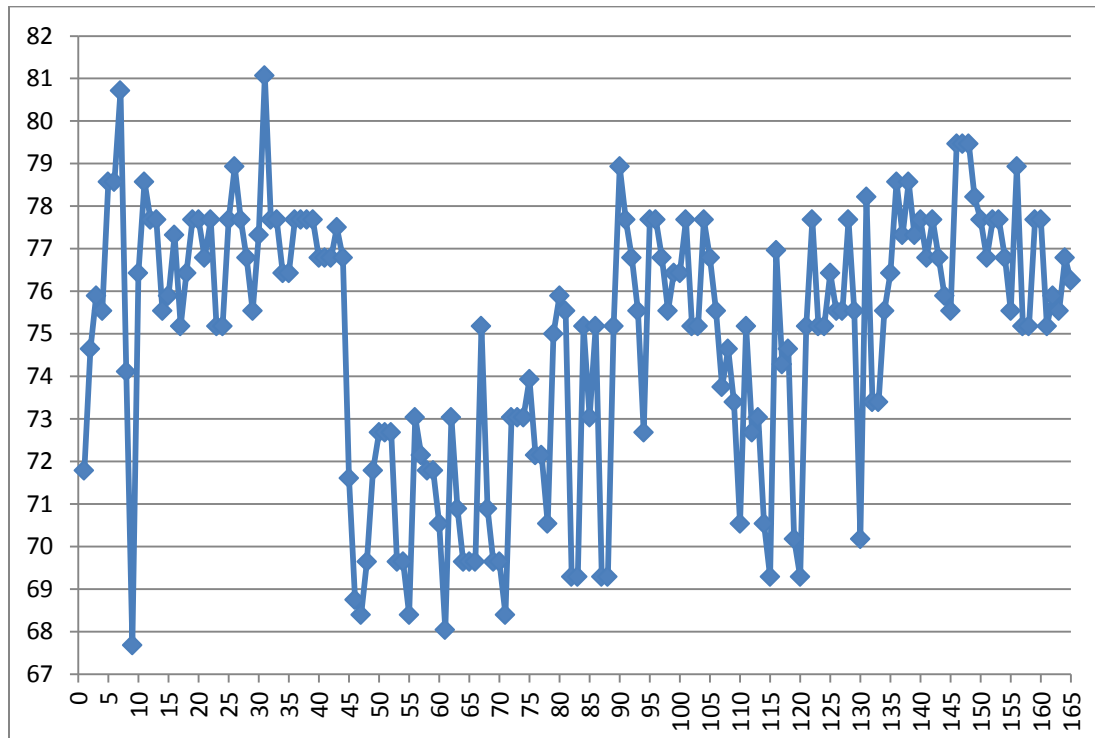

Figure 261: Non Uniform Band Edges Classification Results for the Male DP – HR Reading with the 0 – 3000 Hz Band Range with the Linear Classifier

The following five figures (Figure 262, Figure 263, Figure 264, Figure 265, and Figure 266) show the zoomed in versions of the graph of the Figure 261. These graphs show only 33 points.

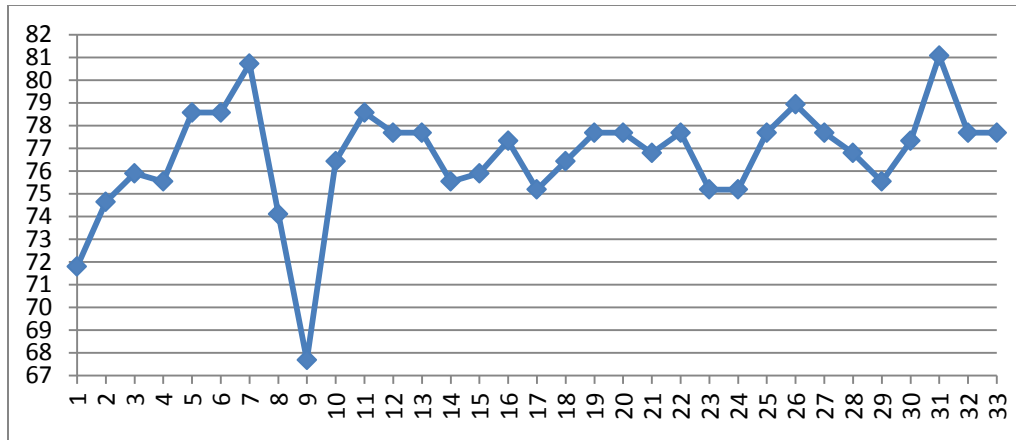

Figure 262: Zoom In Graph between Points 1 – 33 (Male DP – HR Reading between 0 – 3000 Hz Band Range with Linear Classifier)

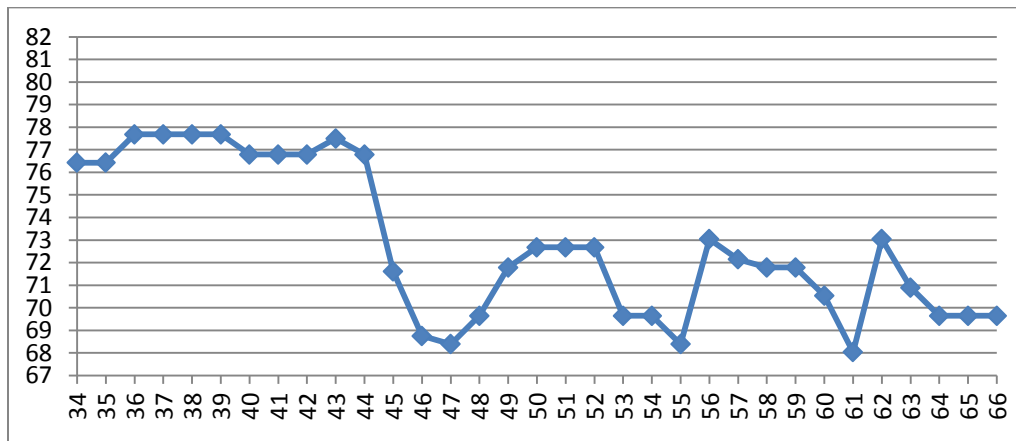

Figure 263: Zoom In Graph between Points 34 – 66 (Male DP – HR Reading between 0 – 3000 Hz Band Range with Linear Classifier)

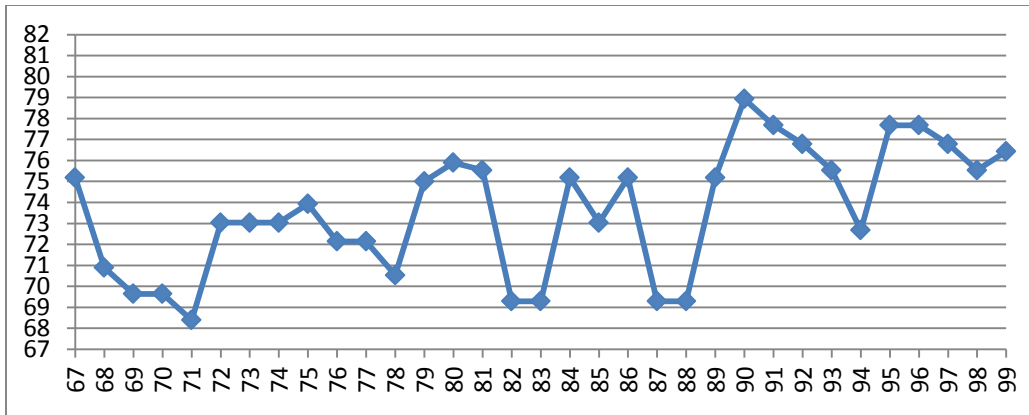

Figure 264: Zoom In Graph between Points 67 – 99 (Male DP – HR Reading between 0 – 3000 Hz Band Range with Linear Classifier)

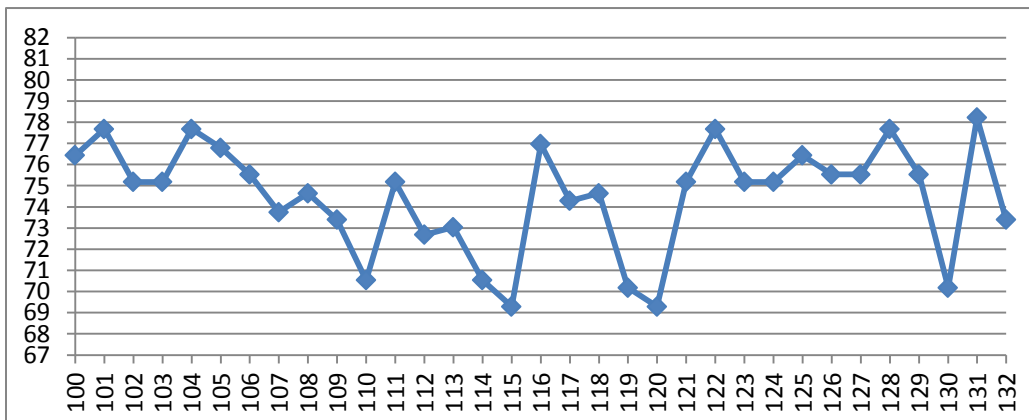

Figure 265: Zoom In Graph between Points 100 – 132 (Male DP – HR Reading between 0 – 3000 Hz Band Range with Linear Classifier)

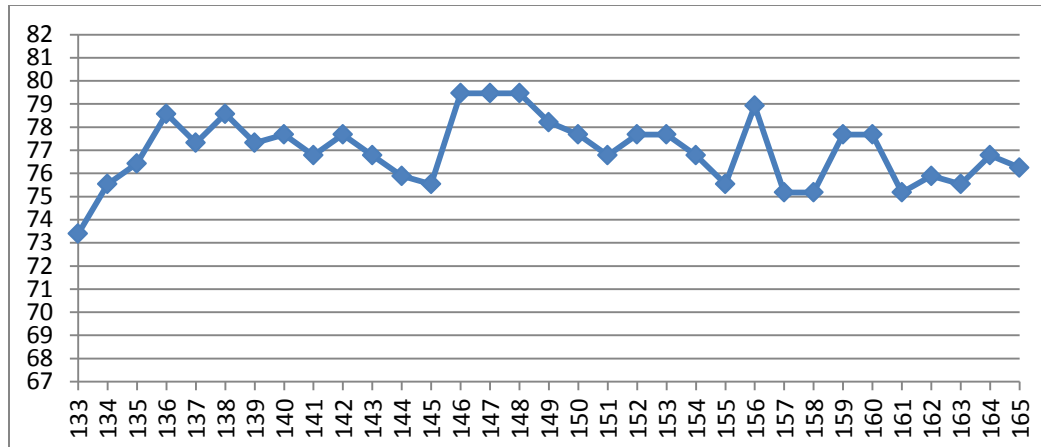

Figure 266: Zoom In Graph between Points 133 – 165 (Male DP – HR Reading between 0 – 3000 Hz Band Range with Linear Classifier)

3.3.2.2.4.2 Quadratic Classification Results

Figure 267 shows the classification rates using the quadratic classifier for the male DP-HR pairwise group during the reading session. According to the quadratic classifier, the maximum classification rate found as 84.107% for the 5th data point (250, 500, 1750) which means the following PSD combination(**PSD 1:** 0 -250 Hz, **PSD 2:** 250-500 Hz, **PSD 3:** 500-1750 Hz, **PSD 4:**1750-3000 Hz).

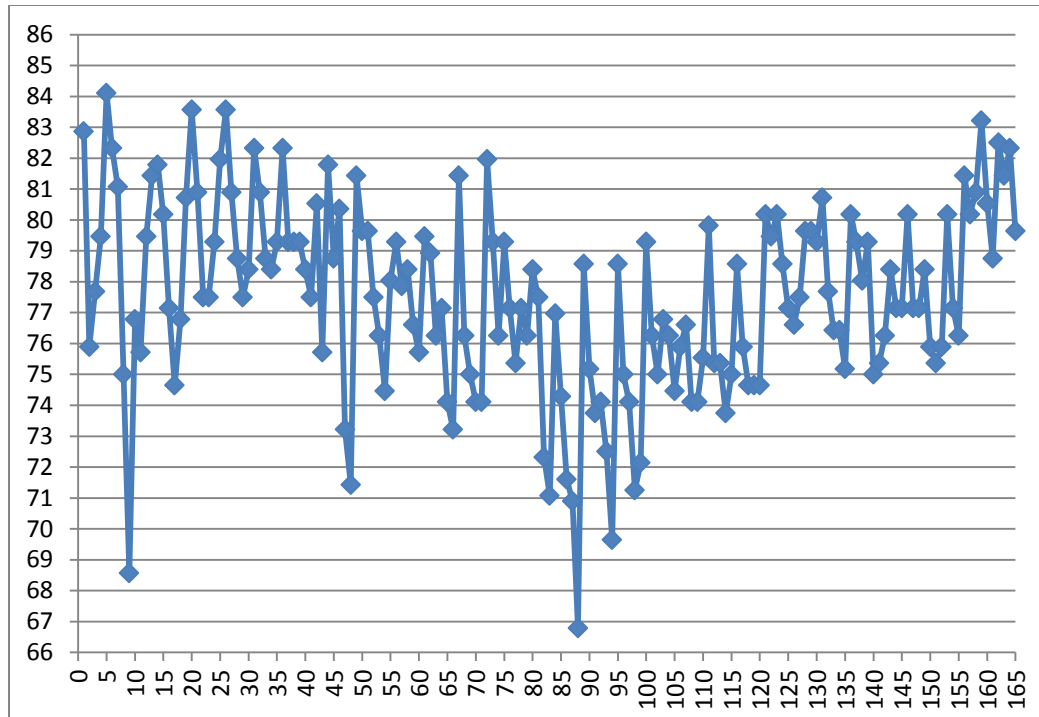

Figure 267: Non Uniform Band Edges Classification Results for the Male DP – HR Reading with the 0 – 3000 Hz Band Range with the Quadratic Classifier

The following five figures (Figure 268, Figure 269, Figure 270, Figure 271, and Figure 272) show the zoomed in versions of the graph of the Figure 267. These graphs show only 33 points.

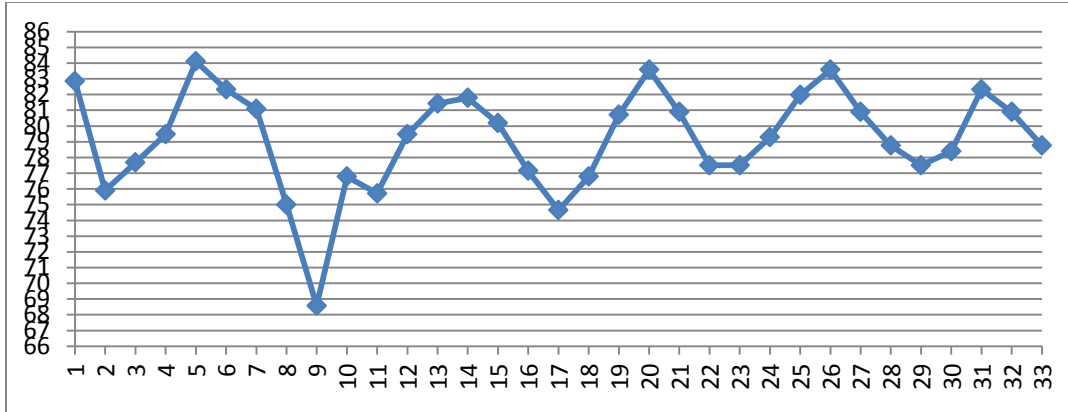

Figure 268: Zoom In Graph between Points 1 – 33 (Male DP – HR Reading between 0 – 3000 Hz Band Range with Quadratic Classifier)

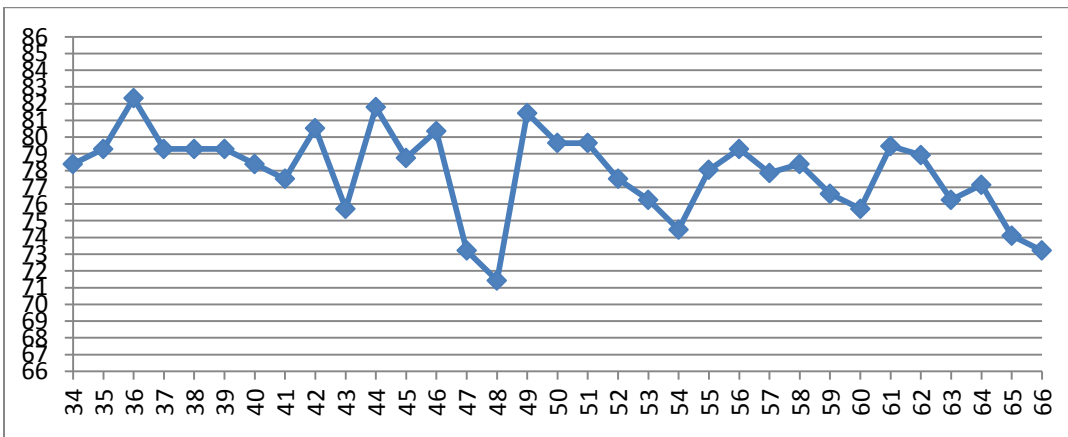

Figure 269: Zoom In Graph between Points 34 – 66 (Male DP – HR Reading between 0 – 3000 Hz Band Range with Quadratic Classifier)

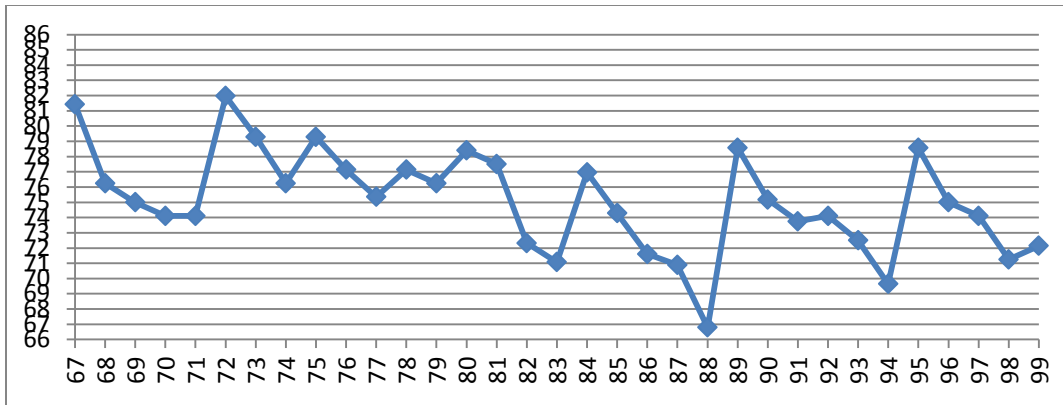

Figure 270: Zoom In Graph between Points 67 – 99 (Male DP – HR Reading between 0 – 3000 Hz Band Range with Quadratic Classifier)

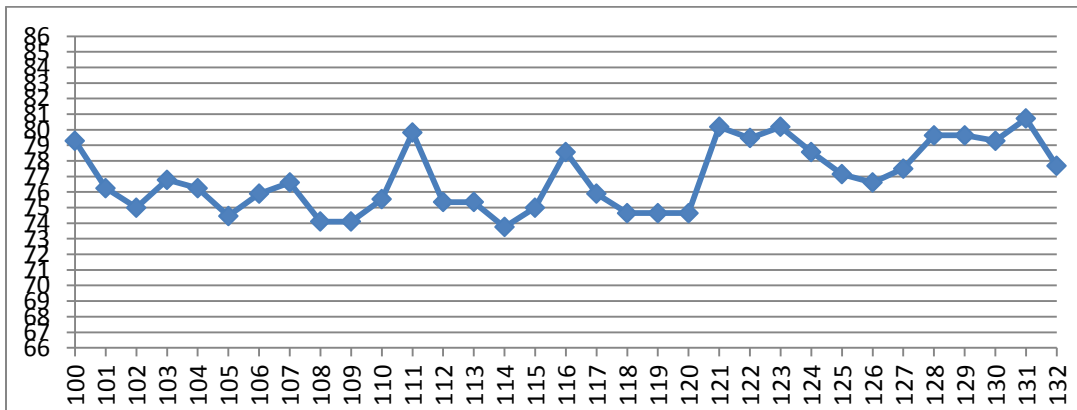

Figure 271: Zoom In Graph between Points 100 – 132 (Male DP – HR Reading between 0 – 3000 Hz Band Range with Quadratic Classifier)

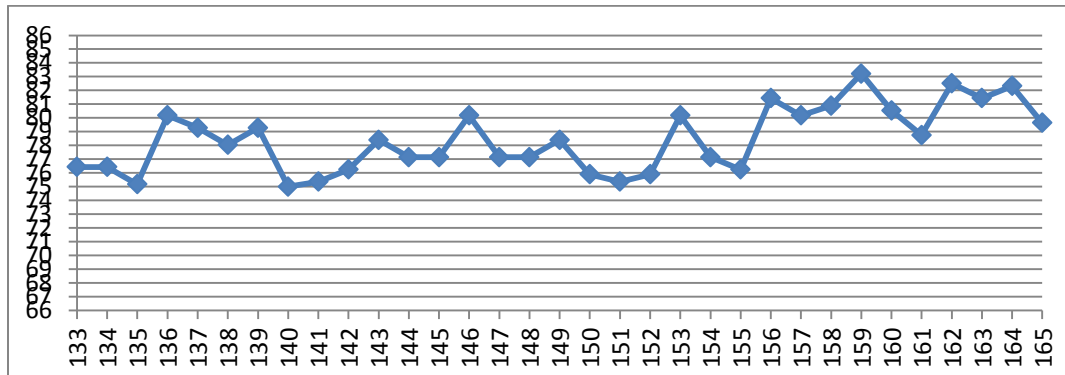

Figure 272: Zoom In Graph between Points 133 – 165 (Male DP – HR Reading between 0 – 3000 Hz Band Range with Quadratic Classifier)

Table 75 shows the highest classification results and the associated data points for these results for the DP- HR pairwise group for the female patients with two different classification methods of the linear classification and quadratic classification for the 0-3000 Hz frequency band range with different session. According to the results, quadratic classification gave better results for both the interview and the reading sessions.

Table 75: Optimized Non Uniform Band Edges Classification Rates for the DP – HR Pair with the 0 – 3000 Hz Band Range for the Female Patients

FEMALE PATIENTS (0 – 3000 Hz)							
Pairwise Group	Fixed Band Number (Optimized Non-Uniform Band Edges)		Classification Rate		Data Point		
	Linear	Quadratic	Linear	Quadratic	Linear	Quadratic	
<u>DP – HR Interview</u>	4 bands	4 bands	71.835%	76.896%	2 nd point (250,500,1000)	2 nd point (250,500,1000)	
<u>DP – HR Reading</u>	4 bands	4 bands	77.928%	78.178%	88 th point (750,1000,2750)	7 th point (250,500,2250)	

The table below, Table 76, shows the highest classification results and the associated data points for these results for the DP- HR pairwise group for the male patients with two different classification methods of the linear classification and quadratic classification for the 0-3000 Hz frequency band range with different session. According to the results, linear classification gave better results for the interview session and the quadratic one gave better result for the reading session.

Table 76: Optimized Non Uniform Band Edges Classification Rates for the DP – HR Pair with the 0 – 3000 Hz Band Range for the Male Patients

MALE PATIENTS (0 – 3000 Hz)						
Pairwise Group	Fixed Band Number (Optimized Non-Uniform Band Edges)		Classification Rate		Data Point	
	Linear	Quadratic	Linear	Quadratic	Linear	Quadratic
DP – HR Interview	4bands	4 bands	81.355%	81.266%	44 th point (250,2250,2750)	50 th point (500,750,2000)
DP – HR Reading	4 bands	4 bands	81.071%	84.107%	31 th point (250,1500,1750)	5 th point (250,500,1750)

4 Performance Evaluation of Optimized Energy Band Study

4.1 Performance Evaluation of Female Patients

The overall performance evaluation for the female patients will be analyzed in this section. First, the classification rates were calculated with fixed band number (4 bands) and fixed band range (0-2000 Hz) for all pairwise groups of female patients during the interview session and the reading session. Then, different band numbers (2, 3, 4, 5, 6, 7, 8, 9 and 10 bands) were analyzed in the 0-2000 Hz frequency range and the optimized band numbers were found for each pairwise group during both sessions. Finally, the same band numbers were studied for the different band range of 0 - 3000 Hz,

and the optimized band numbers were also found for each pairwise group during both sessions for this frequency range of 0 -3000 Hz. Table 77 shows the results for all pairwise groups of female patients with a fixed band number (4 bands); with optimized band numbers with different band ranges (0- 2000 Hz and 0-3000 Hz). Three different classification techniques (linear, quadratic and cross validated) were analyzed and the best classification rates were highlighted in red. The optimized band numbers are highlighted in yellow.

Table 77: Comparison of Performance Evaluation Results for the Female Patients with the Fixed Band Number, the Optimized Band Numbers and the Optimized Band Ranges

FEMALE PATIENTS (0 – 2000 Hz)						
GROUP	Fixed Band Number			Classification Rate		
	Linear	Cross Validated	Quadratic	Linear	Cross Validated	Quadratic
DP – HR Interview	4 bands	4 bands	4 bands	62.40%	61.80%	63.90%
DP – HR Reading	4 bands	4 bands	4 bands	67.00%	65.00%	64.10%
DP – RM Interview	4 bands	4 bands	4 bands	58.50%	58.00%	66.30%
DP – RM Reading	4 bands	4 bands	4 bands	62.10%	61.20%	60.20%
HR – RM Interview	4 bands	4 bands	4 bands	69.80%	68.10%	68.50%
HR – RM Reading	4 bands	4 bands	4 bands	71.60%	68.20%	68.20%
FEMALE PATIENTS (0 – 2000 Hz)						
GROUP	Optimized Band Numbers			Classification Rate		
	Linear	Cross Validated	Quadratic	Linear	Cross Validated	Quadratic
DP – HR Interview	9 bands	9 bands	9 bands	77.90%	77.90%	79.40%
DP – HR Reading	7 bands	7 bands & 3 bands	7 bands & 10 bands	76.70%	68.90%	73.80%
DP – RM Interview	10 bands	10 bands	10 bands	71.00%	69.90%	72.50%
DP – RM Reading	6 bands	6 bands	10 bands	76.70%	74.80%	77.70%
HR – RM Interview	10 bands	10 bands	2 bands	79.40%	76.60%	79.00%
HR – RM Reading	10 bands	7 bands	10 bands	87.50%	83.00%	87.50%
FEMALE PATIENTS (0 – 3000 Hz)						
GROUP	Optimized Band Numbers			Classification Rate		
	Linear	Cross Validated	Quadratic	Linear	Cross Validated	Quadratic
DP – HR Interview	10 bands	10 bands	9 bands	74.80%	73.90%	77.30%
DP – HR Reading	9 bands & 10 bands	9 bands & 10 bands	10 bands	78.60%	72.80%	79.60%
DP – RM Interview	5 bands	5 bands	8 bands	66.30%	65.50%	66.30%
DP – RM Reading	9 bands	9 bands	9 bands	80.60%	79.60%	82.50%
HR – RM Interview	10 bands	10 bands	10 bands	77.40%	75.40%	76.60%
HR – RM Reading	10 bands	10 bands	10 bands	85.20%	80.70%	84.10%

According to the results, the quadratic classification method gave the best results in all three methods for the Depressed - High Risk Suicidal (DP-HR) pairwise group during the interview session. The classification rate is increased from 63.90% to 79.40% when 9 energy bands were used instead of 4 energy bands in the 0-2000 Hz frequency range. The classification rate is 77.30% when 9 energy band numbers were used in the 0-3000 Hz frequency range. So, the optimized band number is 9 bands for the DP-HR pairwise group during the interview session.

For the Depressed - High Risk Suicidal (DP-HR) pairwise group during the reading session, the classification rate is increased from 67.00% to 76.70% when 7 energy band numbers was used instead of 4 energy band numbers in the 0-2000 Hz frequency range. In both of them, the linear classification method was the best classification method. The maximum classification rate is 79.60% when 10 energy band numbers were used in the 0-3000 Hz frequency range with the quadratic classification method. So, the optimized band number is 7 bands in the 0-2000 Hz frequency range and 10 bands in the 0-3000 Hz frequency range for the DP-HR pairwise group during the reading session.

The classification rate was found to be 66.30% with 4 fixed energy bands and in the 0-2000 Hz frequency range for the Depressed - Remitted (DP-RM) pairwise group during the interview session. When the number of bands was increased and the results were analyzed in the 0-2000 Hz frequency range, 10 bands gave the best classification rate with 72.50% using the quadratic classification technique. For the 0-3000 Hz frequency range, both the linear and the quadratic classification method gave the same discrimination rate which is 66.30%. The linear technique gave 5 bands, and quadratic

technique gave 8 bands as optimized band numbers. This percentage is the same rate with the 4 fixed bands in the 0 - 2000 Hz frequency range. So, the optimized band number is 10 bands in the 0-2000 Hz frequency range.

For the Depressed - Remitted (DP-RM) pairwise group during the reading session, the classification rate is increased from 62.10% to 77.70% when 10 energy band numbers was used instead of 4 energy band numbers in the 0-2000 Hz frequency range. In the fixed number of band study, the linear classification method was the best classification method, and it was the quadratic classification method for the other one. The maximum classification rate is 82.50% when 9 energy band numbers were used in the 0-3000 Hz frequency range with the quadratic classification method. So, the optimized band number is 10 bands in the 0-2000 Hz frequency range and 9 bands in the 0-3000 Hz frequency range for the DP-RM pairwise group during the reading session.

According to the results, the linear classification method gave the best results in all three methods for the High Risk Suicidal-Remitted (HR-RM) pairwise group during the interview session. The classification rate is increased from 69.80% to 79.40% when 10 energy band numbers was used instead of 4 energy band numbers in the 0-2000 Hz frequency range. The classification rate is 77.40% when 10 energy band numbers were used in the 0-3000 Hz frequency range. So, the optimized band number is 10 bands for the HR-RM pairwise group during the interview session.

The classification rate was found to be 71.60% with 4 fixed energy bands and in the 0-2000 Hz frequency range for the High Risk Suicidal - Remitted (HR-RM) pairwise group during the reading session using the linear classification. When the number of bands was increased and the results were analyzed in the 0-2000 Hz frequency range, 10

bands gave the best classification rate with 87.50% using both the linear and the quadratic classification techniques. For the 0-3000 Hz frequency range, the linear classification method gave the best discrimination rate which is 85.20%. The linear technique gave 10 bands as optimized band numbers. So, the optimized band number is 10 bands in the 0-2000 Hz frequency range and 0- 3000 Hz frequency range.

To find optimized energy bands, another technique was using the exponential band edges method with keeping the band number fixed at 4 bands and selecting the band edges exponentially. Four exponential edged bands were selected as 0 -250 Hz, 250-500 Hz, 500-1000 Hz and 1000-2000 Hz for the 0-2000 Hz frequency range, and 0-375 Hz, 375-750 Hz, 750-1500 Hz, 1500-3000 Hz for the 0-3000 Hz frequency range. The overall results for the female patients with different pairwise groups and sessions (interview, reading sessions) are shown below in Table 78. Three different classification techniques (linear, quadratic and cross validated) were analyzed and the best classification rates were highlighted in red.

Table 78: Comparison of Performance Evaluation Results for the Female Patients with the Optimized Exponential Band Edges in the 0 – 2000 Hz and 0-3000 Hz Band Ranges

FEMALE PATIENTS (0 – 2000 Hz)						
GROUP	Fixed Band Number			Classification Rate		
	Linear	Cross Validated	Quadratic	Linear	Cross Validated	Quadratic
DP – HR Interview	4 bands	4 bands	4 bands	62.40%	61.80%	63.90%
DP – HR Reading	4 bands	4 bands	4 bands	67.00%	65.00%	64.10%
DP – RM Interview	4 bands	4 bands	4 bands	58.50%	58.00%	66.30%
DP – RM Reading	4 bands	4 bands	4 bands	62.10%	61.20%	60.20%
HR – RM Interview	4 bands	4 bands	4 bands	69.80%	68.10%	68.50%
HR – RM Reading	4 bands	4 bands	4 bands	71.60%	68.20%	68.20%
FEMALE PATIENTS (0 – 2000 Hz)						
GROUP	Fixed Band Number (Optimized Exponential Band Edges)			Classification Rate		
	Linear	Cross Validated	Quadratic	Linear	Cross Validated	Quadratic
DP – HR Interview	4 bands	4 bands	4 bands	72.70%	72.70%	72.70%
DP – HR Reading	4 bands	4 bands	4 bands	71.80%	68.90%	68.90%
DP – RM Interview	4 bands	4 bands	4 bands	60.90%	59.10%	65.30%
DP – RM Reading	4 bands	4 bands	4 bands	62.10%	58.30%	63.10%
HR – RM Interview	4 bands	4 bands	4 bands	70.20%	69.40%	68.10%
HR – RM Reading	4 bands	4 bands	4 bands	75.00%	71.60%	75.00%
FEMALE PATIENTS (0 – 3000 Hz)						
GROUP	Fixed Band Number (Optimized Exponential Band Edges)			Classification Rate		
	Linear	Cross Validated	Quadratic	Linear	Cross Validated	Quadratic
DP – HR Interview	4 bands	4 bands	4 bands	56.70%	56.40%	50.90%
DP – HR Reading	4 bands	4 bands	4 bands	67.00%	66.00%	69.90%
DP – RM Interview	4 bands	4 bands	4 bands	53.40%	51.80%	58.00%
DP – RM Reading	4 bands	4 bands	4 bands	62.10%	61.20%	67.00%
HR – RM Interview	4 bands	4 bands	4 bands	65.70%	64.10%	62.90%
HR – RM Reading	4 bands	4 bands	4 bands	72.70%	67.00%	67.00%

According to the results, the classification rate is increased to 72.70% from 63.90% (with the quadratic classification technique) for the Depressed – High Risk Suicidal (DP-HR) pairwise group during the interview session when optimized exponential band edges were used in the 0-2000 Hz frequency range. All three classification techniques (linear, quadratic, and cross validated) gave the same result with 72.70%. The classification rate is decreased when the exponential band edges technique was applied to the 0-3000 Hz frequency band range. It decreased to 56.70% with using the linear discriminant function. So, the energy bands that were created with the exponential band edges in the 0-2000 Hz could be viewed as optimized energy bands.

For the Depressed – High Risk Suicidal (DP-HR) pairwise group during the reading session, the classification rate had been increased from 67.00% (with linear classification technique) to 71.80% (with linear classification technique) for the 0-2000 Hz frequency range and to 69.90% (with quadratic classification technique) for the 0-3000 Hz frequency range when the optimized exponential band edges were analyzed. So, the energy bands that were created with the exponential band edges in the 0-2000 Hz and 0-3000 Hz could be the optimized energy bands.

The classification rate didn't increase when the optimized exponential band edges were used for the Depressed – Remitted (DP-RM) pairwise group during the interview session. The classification rate is 66.30% with the regular 4 equal frequency bands with the quadratic classification technique. This rate is decreased to 65.30% with quadratic classification technique for the 0-2000 Hz frequency range and to 58.00% with quadratic classification technique for the 0-3000 Hz frequency range. So, the energy bands that

were created with the exponential band are not optimized energy bands for both frequency ranges in the sense that the results did not improve.

For the Depressed – Remitted (DP-RM) pairwise group during the reading session, the classification rate had been increased from 62.10% (with the linear classification technique) to 63.10% (with quadratic classification technique) for the 0-2000 Hz frequency range and to 67.00% (with quadratic classification technique) for the 0-3000 Hz frequency range when the optimized exponential band edges were analyzed. So, the energy bands that were created with the exponential band edges in the 0-2000 Hz and 0-3000 Hz could be the optimized energy bands.

According to the results, the classification rate is increased to 70.20% from 69.80% for the High Risk Suicidal - Remitted (HR-RM) pairwise group during the interview session when optimized exponential band edges were used in the 0-2000 Hz frequency range. The linear classification techniques gave the best result for both of them. The classification rate is decreased when the exponential band edges technique was applied to the 0-3000 Hz frequency band range. It decreased to 65.70% using the linear discriminant function. So, the energy bands that were created with the exponential band edges in the 0-2000 Hz could be viewed as optimized energy bands.

For the High Risk Suicidal- Remitted (HR-RM) pairwise group during the reading session, the classification rate increased from 71.60% (with linear classification technique) to 75.00% (with the linear and quadratic classification techniques) for the 0-2000 Hz frequency range and to 72.70% (with linear classification technique) for the 0-3000 Hz frequency range when the optimized exponential band edges were analyzed. So,

the energy bands that were created with the exponential band edges in the 0-2000 Hz and 0-3000 Hz ranges could be the optimized energy bands.

Another optimization technique was applied by using the non-uniform band edges. For this study, the band edge frequency range is swept in the 0 – 2000 Hz frequency range with 250 Hz frequency increments. Thirty five different combinations of non-uniform energy bands edges were used in the 0 – 2000 Hz frequency range and their classification rates were analyzed. One hundred and sixty five different combinations of non-uniform energy bands edges were determined in the 0 – 3000 Hz frequency range by sweeping the 0 – 3000 Hz frequency range with 250 Hz frequency increment and the classification rates for each of these combinations were examined. The table below, Table 79, shows the best classification rates and the associated optimized energy bands. In this study, only the Depressed - High Risk Suicidal (DP-HR) pairwise group was analyzed with two different classification methods (linear and quadratic) for both sessions (the interview and the reading sessions). The best classification rates were highlighted in red and the associated band edges and energy bands were highlighted in yellow.

Table 79: Comparison of Performance Evaluation Results for the Female Patients with the Non-Uniform Band Edges in the 0 – 2000 Hz and 0-3000 Hz Band Ranges for the DP-HR Pairwise Group

Non-Uniform Band Edges for Female DP- HR Pair						
GROUP	Optimized Non-Uniform Band Edges		Classification Rate		Optimized Energy Bands	
	Linear	Quadratic	Linear	Quadratic	Linear	Quadratic
INTERVIEW 0 - 2000Hz	2nd point (250, 500,1000)	2nd point (250, 500,1000)	71.84%	76.90%	0-250, 250- 500, 500-1000,1000-2000	0-250, 250- 500, 500-1000,1000-2000
INTERVIEW 0 - 3000 Hz	2nd point (250, 500,1000)	2nd point (250, 500,1000)	71.84%	76.90%	0-250, 250- 500, 500-1000,1000-3000	0-250, 250- 500, 500-1000,1000-3000
READING 0-2000 Hz	6th point (250 ,750,1000)	3rd point (250,500,1250) & 4th point (250,500,1500)	74.25%	77.60%	0-250,250-750, 750-1000,1000-2000	0-250,250-500,500-1250,1250-2000 & 0-250, 250-500,500-1500, 1500-2000
READING 0-3000 Hz	88th point (750, 1000,2750)	7th point (250, 500,2250)	77.93%	78.18%	0-750, 750-1000, 1000-2750,2750-3000	0-250, 250-500, 500-2250,2250-3000

According to the results, the quadratic classifier gave the best results for both the interview and the reading sessions in both of the frequency ranges of the 0-2000 Hz and the 0-3000 Hz. For the interview session of the DP-HR pairwise group, the optimized non-uniform band edges and the classification rates were the same for both frequency ranges of the 0-2000 Hz and the 0-3000 Hz. The classification rate was 76.896% and the non-uniform band edges were (250, 500, 1000). So; the optimized energy bands were 0-250 Hz, 250-500 Hz, 500-1000 Hz and 1000-2000 Hz for the 0-2000 Hz frequency ranges and 0-250 Hz, 250-500 Hz, 500-1000 Hz and 1000-3000 Hz for the 0-3000 Hz frequency range.

For the DP-HR pairwise group during the reading session, the optimized non-uniform band edges were found to be (250, 500, 1250) and (250, 500, 1500) for the 0-2000 Hz frequency range. They both gave the classification rate of 77.60%. So, the optimized non-uniform energy bands were found to be 0-250 Hz, 250-500 Hz, 500-1250 Hz and 1250-2000 Hz for the (250, 500, 1250) band edges and 0-250 Hz, 250-500 Hz, 500-1500 Hz and 1500-2000 Hz for the (250, 500, 1500) band edges. For the 0-3000 Hz

frequency range, the DP-HR pairwise group during the reading session had the optimized non-uniform band edges as (250, 500, 2250). It gave the classification rate of 78.178%, and created the optimized non-uniform energy bands as 0-250 Hz, 250-500 Hz, 500-2250 Hz and 2250-3000 Hz.

4.2 Performance Evaluation of Male Patients

The male patients' overall performance is analyzed in this part of the paper. The same analyses which had been performed for the female patients was applied to the male patients. The classification rates were calculated for all pairwise groups of male patients during the interview session and the reading session with:

- Fixed band number (4 bands) and fixed band range (0-2000 Hz)
- Different band numbers (2, 3, 4, 5, 6, 7, 8, 9 and 10 bands) in the 0-2000 Hz frequency range.
- Different band numbers (2, 3, 4, 5, 6, 7, 8, 9 and 10 bands) in the 0-3000 Hz frequency range.

Table 80 shows the results for all pairwise groups of male patients with fixed band number (4 bands); with optimized band numbers with different band ranges (0-2000 Hz and 0-3000 Hz). Three different classification techniques (linear, quadratic and cross validated) were analyzed and the best classification rates were highlighted in red. The optimized band numbers are highlighted in yellow.

Table 80: Comparison of Performance Evaluation Results for the Male Patients with the Fixed Band Number, the Optimized Band Numbers and the Optimized Band Ranges

MALE PATIENTS (0 – 2000 Hz)						
GROUP	Fixed Band Number			Classification Rate		
	Linear	Cross Validated	Quadratic	Linear	Cross Validated	Quadratic
DP – HR Interview	4 bands	4 bands	4 bands	73.30%	72.70%	73.70%
DP – HR Reading	4 bands	4 bands	4 bands	62.50%	60.40%	64.60%
DP – RM Interview	4 bands	4 bands	4 bands	83.00%	82.30%	83.00%
DP – RM Reading	4 bands	4 bands	4 bands	73.70%	72.70%	75.80%
HR – RM Interview	4 bands	4 bands	4 bands	79.20%	77.90%	79.20%
HR – RM Reading	4 bands	4 bands	4 bands	72.30%	72.30%	67.50%
MALE PATIENTS (0 – 2000 Hz)						
GROUP	Optimized Band Numbers			Classification Rate		
	Linear	Cross Validated	Quadratic	Linear	Cross Validated	Quadratic
DP – HR Interview	9 bands	3 bands	3 bands	75.90%	75.20%	76.50%
DP – HR Reading	10 bands	10 bands	10 bands	76.00%	71.90%	78.10%
DP – RM Interview	8 bands	4 bands & 8 bands	9 bands	84.20%	82.30%	84.50%
DP – RM Reading	10 bands	6 bands	4 bands & 10 bands	75.80%	73.70%	75.80%
HR – RM Interview	9 bands & 10 bands	9 bands	9 bands & 10 bands	85.10%	84.40%	85.10%
HR – RM Reading	9 bands	9 bands	9 bands	81.90%	78.30%	81.90%
MALE PATIENTS (0 – 3000 Hz)						
GROUP	Optimized Band Numbers			Classification Rate		
	Linear	Cross Validated	Quadratic	Linear	Cross Validated	Quadratic
DP – HR Interview	9 bands	9 bands	9 bands	81.30%	81.00%	81.30%
DP – HR Reading	9 bands	2 bands & 4 bands	2 bands & 9 bands	77.10%	74.00%	76.00%
DP – RM Interview	10 bands	9 bands	8 bands & 9 bands & 10 bands	83.40%	81.90%	82.60%
DP – RM Reading	5 bands & 10 bands	5 bands	5 bands & 10 bands	76.80%	73.70%	75.80%
HR – RM Interview	10 bands	8 bands	8 bands	89.00%	87.70%	88.60%
HR – RM Reading	10 bands	7 bands & 10 bands	9 bands & 10 bands	84.30%	80.70%	84.30%

According to the results, the classification rate is increased from 73.70% to 76.50% when 3 energy band numbers was used instead of 4 energy band numbers in the 0-2000 Hz frequency range for the Depressed - High Risk Suicidal (DP-HR) pairwise group during the interview session. In both of the studies, the quadratic classification method gave the best results. The classification rate is 81.30% when 9 energy band numbers were used in the 0-3000 Hz frequency range with using the linear and quadratic classification methods. So, the optimized band number is 3 bands in the 0-2000 Hz frequency range and 9 bands in the 0-3000 Hz frequency range for the DP-HR pairwise group during the interview session.

For the Depressed - High Risk Suicidal (DP-HR) pairwise group during the reading session, the classification rate is increased from 64.60% to 78.10% when 10 energy band numbers were used instead of 4 energy band numbers in the 0-2000 Hz frequency range. In both of them, the quadratic classification method was the best classification method. The maximum classification rate is 77.10% when 9 energy band numbers were used in the 0-3000 Hz frequency range with the linear classification method. So, the optimized band number is 10 bands in the 0-2000 Hz frequency range and 9 bands in the 0-3000 Hz frequency range for the DP-HR pairwise group during the reading session.

The classification rate was found to be 83.00% with 4 fixed energy bands and in the 0-2000 Hz frequency range for the Depressed - Remitted (DP-RM) pairwise group during the interview session with both the linear and the quadratic classification techniques. When the number of bands was increased and the results were analyzed in the 0-2000 Hz frequency range, 9 bands gave the best classification rate with 84.50% using

the quadratic classification technique. For the 0-3000 Hz frequency range, linear classification method gave the same discrimination rate of 83.40%. The linear technique gave 10 bands as optimized band numbers. So, the optimized band number is 9 bands in the 0-2000 Hz frequency range and the optimized band number is 10 bands in the 0-3000 Hz frequency range.

For the Depressed - Remitted (DP-RM) pairwise group during the reading session, the classification rate didn't change when different energy bands were tried in the 0-2000 Hz frequency range. The best classification rate is obtained with 4 bands and 10 bands which is 75.80%. In the fixed number of band study, the quadratic classification method was the best classification method which also gave 75.80%, and it was both the linear and the quadratic classification method for the other one. The maximum classification rate is increased to 76.80% when 5 energy band numbers or 10 energy bands were used in the 0-3000 Hz frequency range with the linear classification method. So, the optimized band number couldn't be obtained in the 0-2000 Hz frequency range and it was obtained with 5 and 10 bands in the 0-3000 Hz frequency range for the DP-RM pairwise group during the reading session.

According to the results, the linear and quadratic classification method gave the best results in the fixed band study and different energy bands study in the 0-20000 Hz for the High Risk Suicidal-Remitted (HR-RM) pairwise group during the interview session. The classification rate is increased from 79.20% to 85.10% when 9 and 10 energy band numbers were used instead of 4 energy band numbers in the 0-2000 Hz frequency range. The best classification rate is found to be 89.00% when 10 energy band numbers were used in the 0-3000 Hz frequency range with linear classification method.

So, for the HR-RM pairwise group during the interview session, the optimized band number is 9 and 10 bands for the 0-2000 Hz frequency range, and 10 bands for the 0-3000 Hz frequency range.

The classification rate was found to be 72.30% with 4 fixed energy bands and in the 0-2000 Hz frequency range for the High Risk Suicidal - Remitted (HR-RM) pairwise group during the reading session using linear and cross validated classification. When the number of bands was increased and the results were analyzed in the 0-2000 Hz frequency range, 9 bands gave the best classification rate with 81.90% using both the linear and the quadratic classification techniques. For the 0-3000 Hz frequency range, the linear and quadratic classification method gave the best discrimination rate which is 84.30%. The linear technique gave 10 bands as optimized band numbers and quadratic technique gave 9 and 10 bands as optimized band numbers. So, the optimized band number is 9 bands in the 0-2000 Hz frequency range and 9 and 10 bands in the 0-3000 Hz frequency range.

Exponential band edges method was also used to find optimized energy bands, in this method the band number was kept fixed at 4 bands and the band edges were selected exponentially. Four exponential edged bands were selected as 0 -250 Hz, 250-500 Hz, 500-1000 Hz and 1000-2000 Hz for the 0-2000 Hz frequency range and it was chosen as 0-375 Hz, 375-750 Hz, 750-1500 Hz, 1500-3000 Hz for the 0-3000 Hz frequency range. The overall results for the male patients with different pairwise groups and sessions (interview, reading sessions) are shown below in Table 81. Three different classification techniques (linear, quadratic and cross validated) were analyzed and the best classification rates were highlighted in red.

Table 81: Comparison of Performance Evaluation Results for the Male Patients with the Optimized Exponential Band Edges in the 0 – 2000 Hz and 0-3000 Hz Band Ranges

MALE PATIENTS (0 – 2000 Hz)						
GROUP	Fixed Band Number			Classification Rate		
	Linear	Cross Validated	Quadratic	Linear	Cross Validated	Quadratic
DP – HR Interview	4 bands	4 bands	4 bands	73.30%	72.70%	73.70%
DP – HR Reading	4 bands	4 bands	4 bands	62.50%	60.40%	64.60%
DP – RM Interview	4 bands	4 bands	4 bands	83.00%	82.30%	83.00%
DP – RM Reading	4 bands	4 bands	4 bands	73.70%	72.70%	75.80%
HR – RM Interview	4 bands	4 bands	4 bands	79.20%	77.90%	79.20%
HR – RM Reading	4 bands	4 bands	4 bands	72.30%	72.30%	67.50%
MALE PATIENTS (0 – 2000 Hz)						
GROUP	Fixed Band Number (Optimized Exponential Band Edges)			Classification Rate		
	Linear	Cross Validated	Quadratic	Linear	Cross Validated	Quadratic
DP – HR Interview	4 bands	4 bands	4 bands	74.00%	73.70%	74.00%
DP – HR Reading	4 bands	4 bands	4 bands	74.00%	71.90%	75.00%
DP – RM Interview	4 bands	4 bands	4 bands	77.70%	77.40%	81.10%
DP – RM Reading	4 bands	4 bands	4 bands	70.70%	69.70%	74.70%
HR – RM Interview	4 bands	4 bands	4 bands	78.90%	77.60%	77.90%
HR – RM Reading	4 bands	4 bands	4 bands	72.30%	69.90%	69.90%
MALE PATIENTS (0 – 3000 Hz)						
GROUP	Fixed Band Number (Optimized Exponential Band Edges)			Classification Rate		
	Linear	Cross Validated	Quadratic	Linear	Cross Validated	Quadratic
DP – HR Interview	4 bands	4 bands	4 bands	79.00%	79.00%	79.40%
DP – HR Reading	4 bands	4 bands	4 bands	65.60%	63.50%	66.70%
DP – RM Interview	4 bands	4 bands	4 bands	58.90%	58.50%	61.10%
DP – RM Reading	4 bands	4 bands	4 bands	68.70%	68.70%	69.70%
HR – RM Interview	4 bands	4 bands	4 bands	82.80%	82.50%	82.80%
HR – RM Reading	4 bands	4 bands	4 bands	79.50%	77.10%	75.90%

According to the results, the classification rate is increased to 74.00% (with linear and quadratic technique) from 73.70% (with quadratic classification technique) for the Depressed – High Risk Suicidal (DP-HR) pairwise group during the interview session when optimized exponential band edges were used in the 0-2000 Hz frequency range. The classification rate is increased to 79.40% (with quadratic classification technique) when the exponential band edges technique was applied to the 0-3000 Hz frequency band range. So, the energy bands that were created with the exponential band edges in the 0-2000 Hz and in the 0-3000 Hz could be viewed as optimized energy bands.

For the Depressed – High Risk Suicidal (DP-HR) pairwise group during the reading session, the classification rate had been increased from 64.60% (with quadratic classification technique) to 75.00% (with quadratic classification technique) for the 0-2000 Hz frequency range and to 66.70% (with quadratic classification technique) for the 0-3000 Hz frequency range when the optimized exponential band edges were analyzed. So, the energy bands that were created with the exponential band edges in the 0-2000 Hz and 0-3000 Hz could be viewed as optimized energy bands.

The classification rate didn't increase when the optimized exponential band edges were used for the Depressed – Remitted (DP-RM) pairwise group during the interview session. The classification rate is 83.00% with the regular 4 equal frequency bands with the linear and quadratic classification technique. This rate is decreased to 81.10% with quadratic classification technique for the 0-2000 Hz frequency range and to 61.10% with quadratic classification technique for the 0-3000 Hz frequency range. So, the energy bands that were created with the exponential band are not optimized energy bands for both frequency ranges.

The classification rate didn't increase when the optimized exponential band edges were used for the Depressed – Remitted (DP-RM) pairwise group during the reading session. The classification rate is 75.80% with the regular 4 equal frequency bands with the quadratic classification technique. This rate is decreased to 74.70% with quadratic classification technique for the 0-2000 Hz frequency range and to 69.70% with quadratic classification technique for the 0-3000 Hz frequency range. So, the energy bands that were created with the exponential band are not the optimized energy bands for both frequency ranges.

According to the results, the classification rate is decreased to 78.90% (with linear classification technique) from 79.20% (with linear and quadratic classification technique) for the High Risk Suicidal - Remitted (HR-RM) pairwise group during the interview session when optimized exponential band edges were used in the 0-2000 Hz frequency range. The classification rate is increased when the exponential band edges technique was applied to the 0-3000 Hz frequency band range. It increased to 82.80% with using both the linear and the quadratic discriminant functions. So, the energy bands that were created with the exponential band edges in the 0-3000 Hz could be viewed as optimized energy bands.

For the High Risk Suicidal- Remitted (HR-RM) pairwise group during the reading session, the classification rate hadn't been changed. It is 72.30% (with linear and cross validated classification technique) for the regular bands and it is also 72.30% (with linear classification technique) for the 0-2000 Hz frequency range. The classification rate is increased to 79.50% (with linear classification technique) for the 0-3000 Hz frequency range when the optimized exponential band edges were analyzed. So, the energy bands

that were created with the exponential band edges in the 0-3000 Hz could be viewed as optimized energy bands.

Table 82 shows the best classification rates and the associated optimized energy bands for the non-uniform band edges study. As explained before, the band edge frequency range is swept in between 0 – 2000 Hz frequency range with 250 Hz frequency increment to have non-uniform band ranges for finding the optimized energy bands. Thirty five different combinations of non-uniform energy bands edges were used in the 0 – 2000 Hz frequency range and their classification rates were analyzed. One hundred and sixty five different combinations of non-uniform energy bands edges were determined in the 0 – 3000 Hz frequency range by sweeping the 0 – 3000 Hz frequency range with 250 Hz frequency increment and the classification rates for each of these combinations were examined. In this study, only the Depressed - High Risk Suicidal (DP-HR) pairwise group was analyzed with two different classification methods (linear and quadratic) for both sessions (the interview and the reading sessions). The best classification rates were highlighted in red and the associated band edges and energy bands were highlighted in yellow.

Table 82: Comparison of Performance Evaluation Results for the Male Patients with the Non-Uniform Band Edges in the 0 – 2000 Hz and 0-3000 Hz Band Ranges for the DP-HR Pairwise Group

Non-Uniform Band Edges for Male DP- HR Pair						
GROUP	Optimized Non-Uniform Band Edges		Classification Rate		Optimized Energy Bands	
	Linear	Quadratic	Linear	Quadratic	Linear	Quadratic
INTERVIEW 0 - 2000Hz	8th point (250,750,1500) & 15th point (250,1500,1750)& 18th point (500,750,1500) 25th point (500,1500,1750)	18th point (500, 750,1500)	79.05%	80.99%	0-250,250-750, 750- 1500, 1500-2000 & 0-250, 250-1500, 1500-1750, 1750-2000 & 0-500, 500-750,750-1500, 1500-2000, & 0-500, 500-1500, 1500- 1750, 1750-2000	0-500,500-750, 750-1500,1500-2000
INTERVIEW 0 - 3000 Hz	44th point (250,2250,2750)	50th point (500, 750,2000)	81.36%	81.27%	0-250,250-2250,2250-2750, 2750-3000	0-500,500-750, 750-2000, 2000-3000
READING 0-2000 Hz	15th point (250,1500, 1750)	5th point (250, 500,1750)	81.07%	84.11%	0-250,250-1500, 1500-1750, 1750-2000	0-250,250-500, 500-1750,1750-2000
READING 0-3000 Hz	31th point (250,1500, 1750)	5th point (250, 500,1750)	81.07%	84.11%	0-250, 250-1500, 1500-1750, 1750-3000	0-250, 250-500, 500-1750, 1750-3000

For the optimized non-uniform band edges study of male patients, the quadratic classifier gave the best results for the male DP- HR reading sessions in the 0-2000 Hz and the 0-3000 Hz, and the interview session in the 0-2000 Hz. The linear classifier gave the best result with the male DP-HR pairwise group interview session in the 0-3000 Hz frequency range.

For the male DP-HR pairwise group during the interview session, the optimized non-uniform band edges were found to be (500, 750, 1500) for the 0-2000 Hz frequency range. The classification rate was found to be 80.987%. So, the optimized non-uniform energy bands were found to be 0-500 Hz, 500-750 Hz, 750-1500 Hz and 1500-2000 Hz for the (500, 750, 1500) band edges. For the 0-3000 Hz frequency range, the male DP-HR pairwise group during the interview session had the optimized non-uniform band edges as (250, 2250, 2750). It gave the classification rate of 81.355%, and created the optimized non-uniform energy bands as 0-250 Hz, 250-2250 Hz, 2250-2750 Hz and 2750-3000 Hz.

The optimized non-uniform band edges and the classification rates were the same for both frequency ranges of the 0-2000 Hz and the 0-3000 Hz for the reading session of the DP-HR pairwise group of the male patients. The classification rate was 84.107% and the non-uniform band edges were (250, 500, 1750). So, the optimized energy bands were 0-250 Hz, 250-500 Hz, 500-1750 Hz and 1750-2000 Hz for the 0-2000 Hz frequency range and they are 0-250 Hz, 250-500 Hz, 500-1750 Hz and 1750-3000 Hz for the 0-3000 Hz frequency range.

5 Discussion and Conclusion

5.1 Discussion and Conclusion for the Female Patients

The aim of this research was finding optimized energy bands that give better classification rates than the regular energy bands (0-500 Hz, 500- 1000 Hz, 1000-1500 Hz, 1500-2000 Hz) that had been analyzed before with 4 fixed bands and uniformly placed band edges in the 0-2000 Hz frequency range.

The first technique was increasing number of energy bands and analyzing how the classification rates are affected with this change. When the number of energy bands was increased, female patients' classification rates were also increased. Figure 273 below shows the results with the linear classifier. When the quadratic classifier was used, the same result was achieved which is shown below in Figure 274 and the same result was also achieved when the cross validated classifier was used (Figure 275). So, we can conclude that increasing the number of energy bands is a good way to optimize energy bands for the female patients.

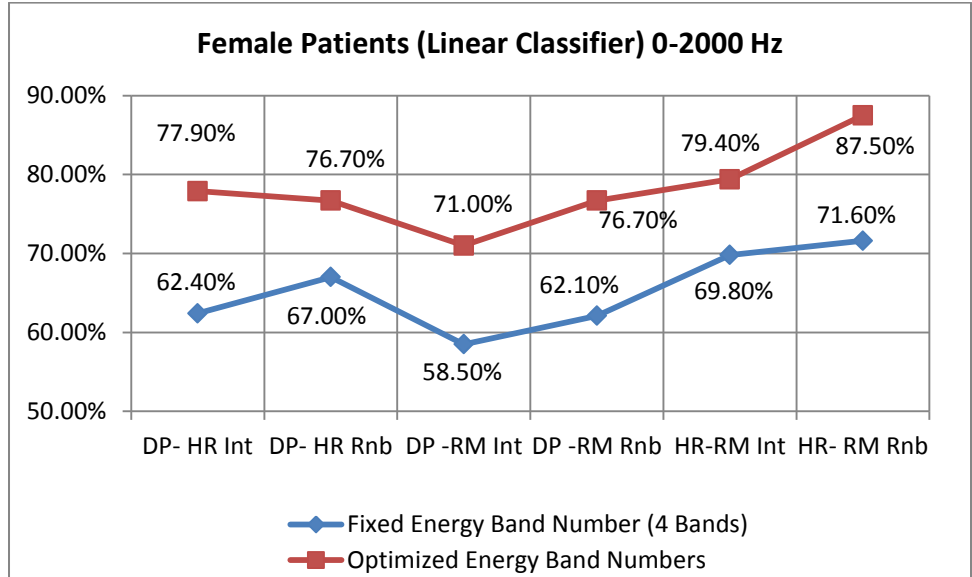

Figure 273: Female Patients' Results Comparison with Linear Classifier

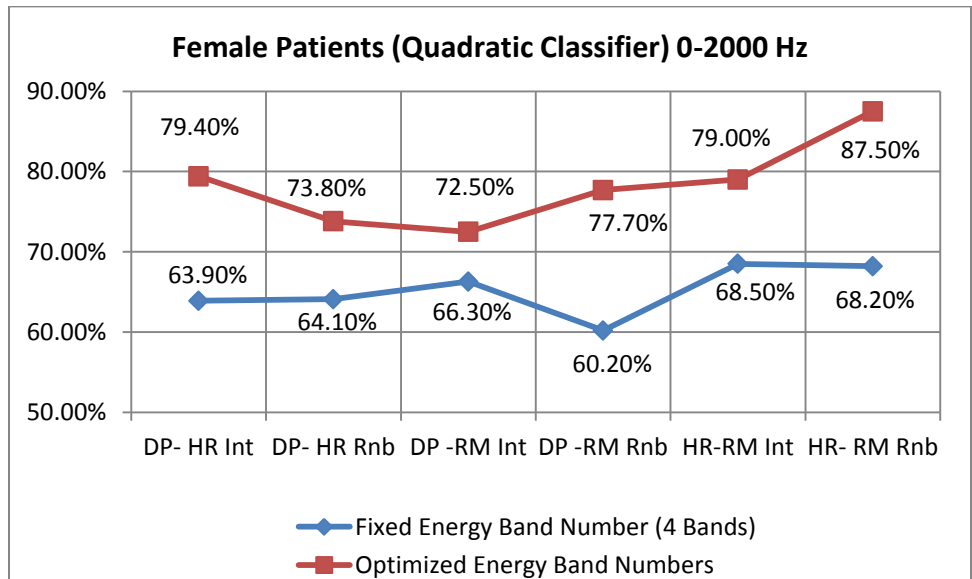

Figure 274: Female Patients' Results Comparison with Quadratic Classifier

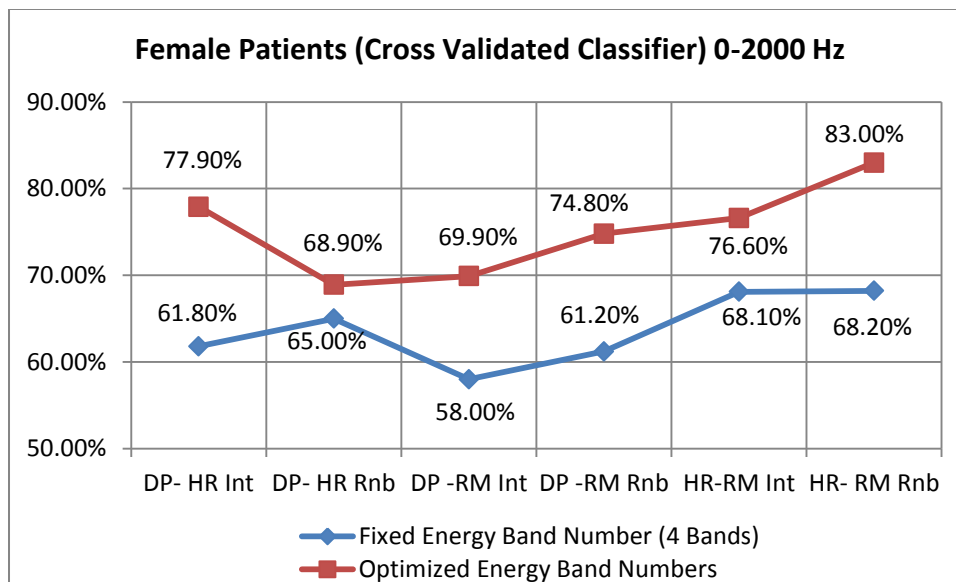

Figure 275: Female Patients’ Results Comparison with Cross Validated Classifier

Another technique was increasing the band range from the 0-2000 Hz to the 0-3000 Hz and having 4 fixed energy bands. Using the linear classifier; the DP-HR interview, DP-RM interview, and DP-RM reading gave better results when the frequency range is increased to 0-3000 Hz. The DP- HR reading, HR-RM interview and HR-RM reading didn’t give better results when the frequency range is increased while linear classifier is used. These results can be seen in Figure 276.

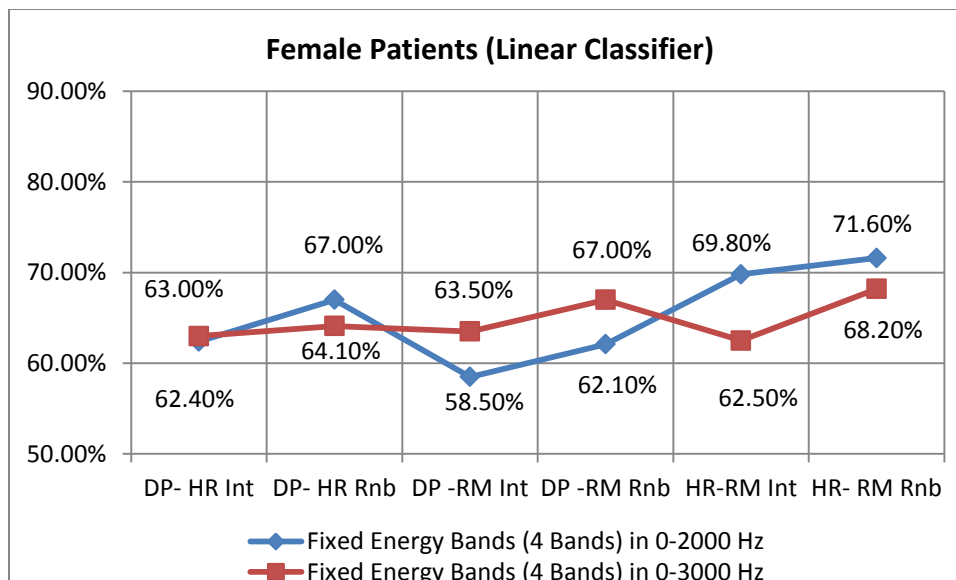

Figure 276: Female Patients' Different Frequency Ranges Results with Linear Classifier

When the quadratic classifier was used; only the DP- HR reading and DP-RM reading gave better results when the frequency range is increased to 0-3000 Hz. All the pairwise groups during the interview session (DP-HR interview, DP-RM interview, HR-RM interview) gave better results when the frequency range was kept in the 0-2000 Hz frequency range. The classification rates were exactly the same for both the 0-2000 Hz and the 0-3000 Hz frequency ranges for the HR-RM reading session. These results can be seen in Figure 277 below.

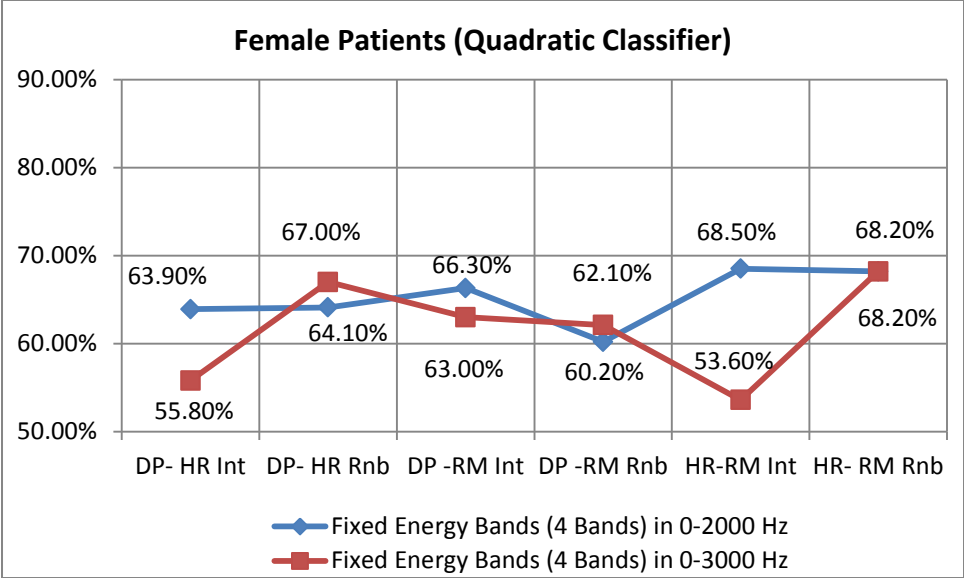

Figure 277: Female Patients’ Different Frequency Ranges Results with Quadratic Classifier

When the cross validated classifier was used, only the DP-RM pairwise group during both the interview and the reading sessions gave better classification results when the frequency range was increased from the 0-2000 Hz to the 0-3000 Hz. For the rest of the pairwise groups (DP-HR interview, DP- HR reading, HR-RM interview and HR-RM reading), the classification rates were better in the 0-2000 Hz frequency range. These results can be seen in Figure 278 below.

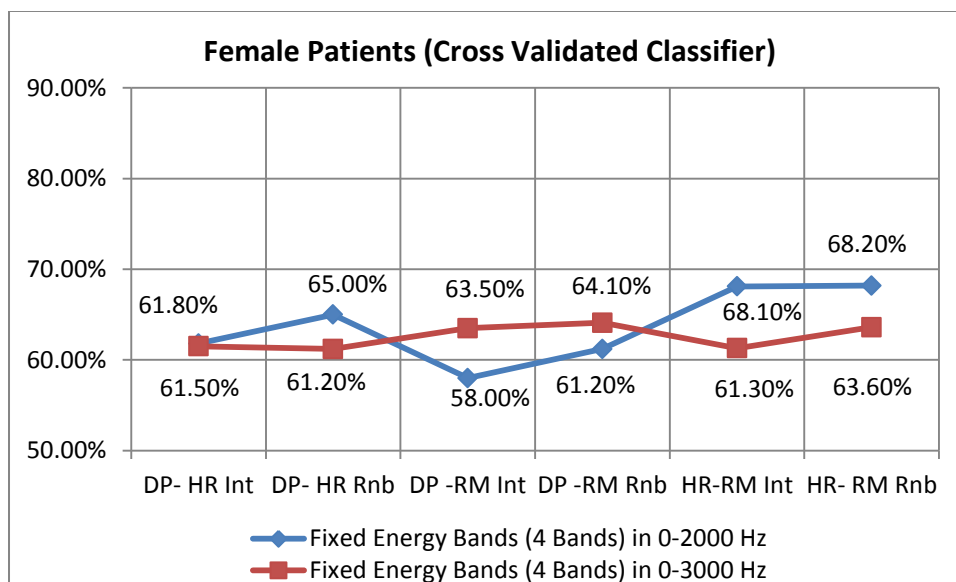

Figure 278: Female Patients’ Different Frequency Ranges Results with Cross Validated Classifier

Since all of the classifiers gave different results and increasing the frequency range didn’t yield better results, we can conclude that, in general increasing the frequency range to 0-3000 Hz doesn’t give optimized energy bands for the female patients.

Increasing the number of energy bands was also applied to the 0-3000 Hz frequency range and how the classification rates are affected with this change were also analyzed. Afterwards, the results of 4 fixed energy bands in the 0-2000 Hz and the results from increasing the number of bands in the 0-3000 Hz frequency range were compared below. Figure 279 shows the results using the linear classifier, Figure 280 shows the results using the quadratic classifier, and Figure 281 shows the results with the cross validated classifier. When the number of energy bands was increased in the new frequency range of 0-3000 Hz, female patients’ classification rates were also increased

except for the DP-RM interview session with the quadratic classifier. So, we can conclude that increasing the number of energy bands in the new frequency range of 0-3000 Hz is also good way to optimize energy bands for the female patients.

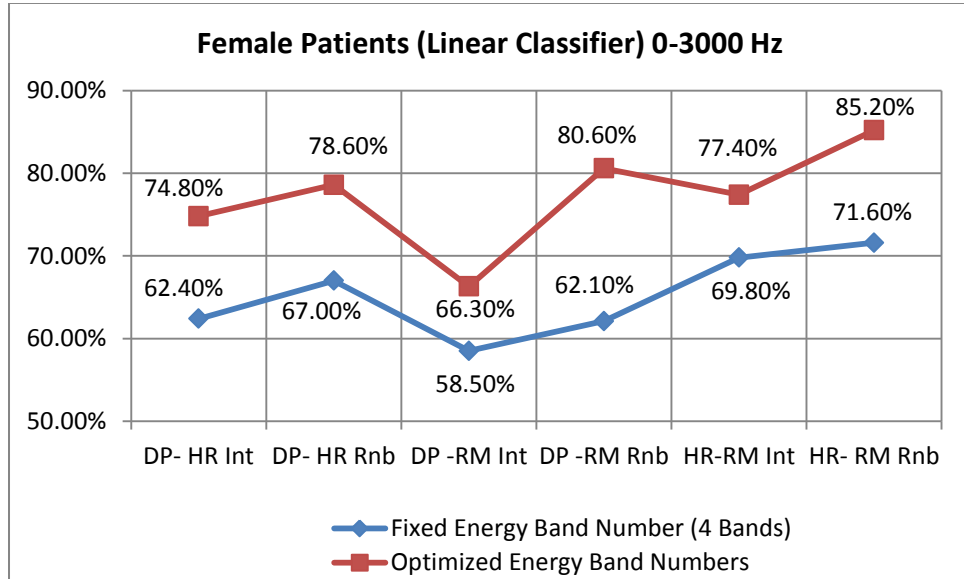

Figure 279: Female Patients’ Results Comparison with Linear Classifier in the 0-3000 Hz Frequency Range

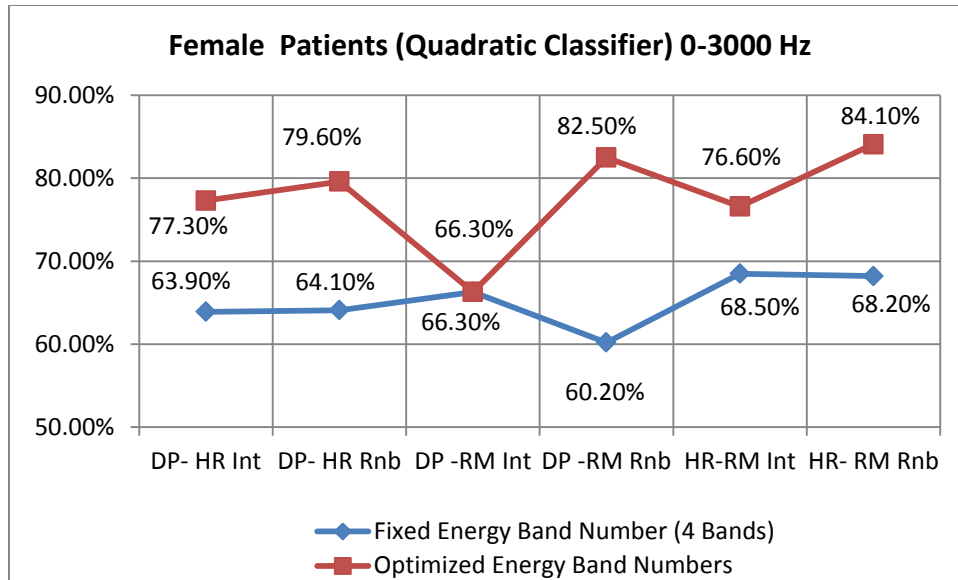

Figure 280: Female Patients' Results Comparison with Quadratic Classifier in the 0-3000 Hz Frequency Range

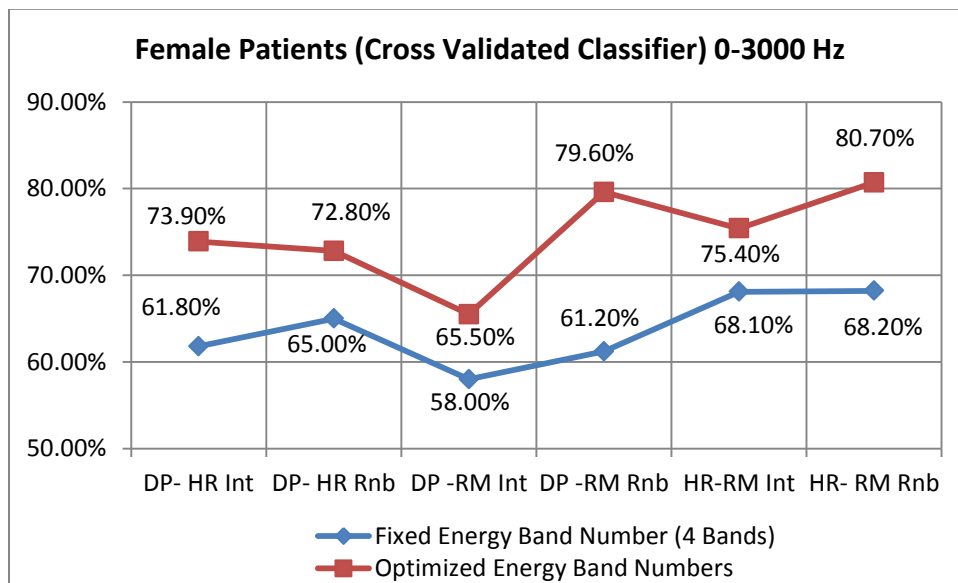

Figure 281: Female Patients' Results Comparison with Cross Validated Classifier in the 0-3000 Hz Frequency Range

After modifying the number of energy bands and modifying the frequency range of the energy bands, different band edges were used to find optimized energy bands. Instead of regular band edges, exponential band edges were used with 4 bands in the 0 – 2000 Hz frequency range. The four exponential edged bands were selected as 0 -250 Hz, 250-500 Hz, 500-1000 Hz and 1000-2000 Hz for the 0-2000 Hz frequency range. The Depressed - High Risk Suicidal (DP-HR) pairwise group during the interview session, Depressed - High Risk Suicidal (DP-HR) pairwise group during the reading session, and the High Risk Suicidal – Remitted (HR-RM) pairwise group during the reading session gave better classification rates with this modification with three different classifiers. Figure 282 shows the results with the linear classifier; Figure 283 shows the results with quadratic classifier, Figure 284 shows the results with the cross validated classifier. The other pairwise groups (DP-RM interview, DP-RM reading, HR-RM interview) didn't always give better classification rates. They sometimes decreased, sometimes showed a little increase and sometimes didn't change with the exponential band edge modification with different classifiers. So, the exponential band edges can be viewed as optimized energy bands for the DP-HR interview session, DP-HR reading session, and HR-RM reading pairwise groups in the 0-2000 Hz frequency range.

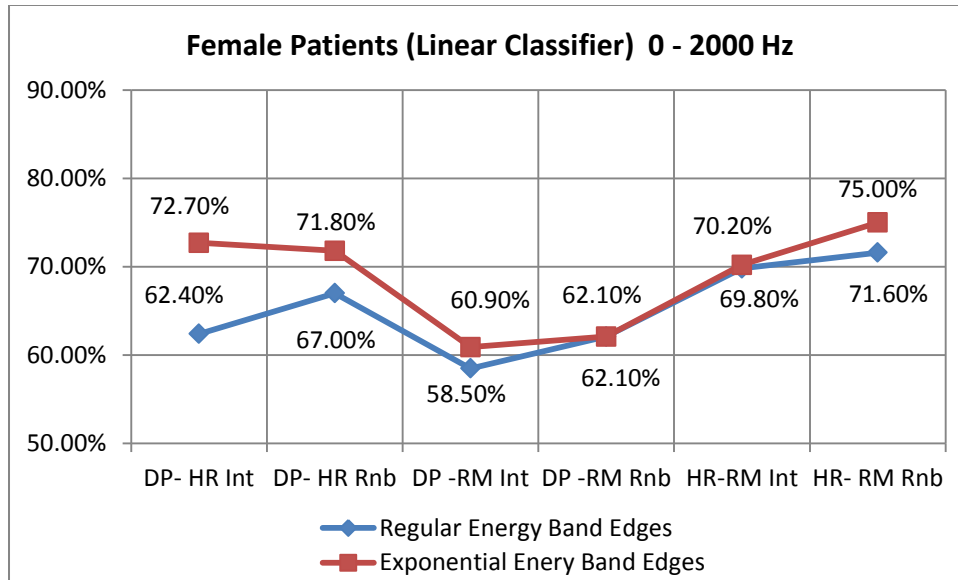

Figure 282: Female Patients' Results of Exponential Band Edges with Linear Classifier in the 0-2000 Hz Frequency Range

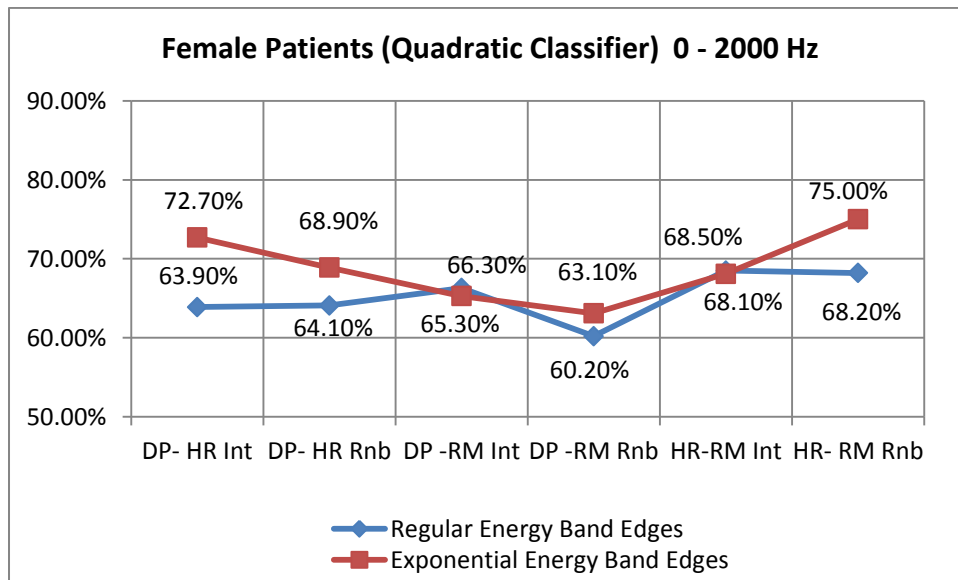

Figure 283: Female Patients' Results of Exponential Band Edges with Quadratic Classifier in the 0-2000 Hz Frequency Range

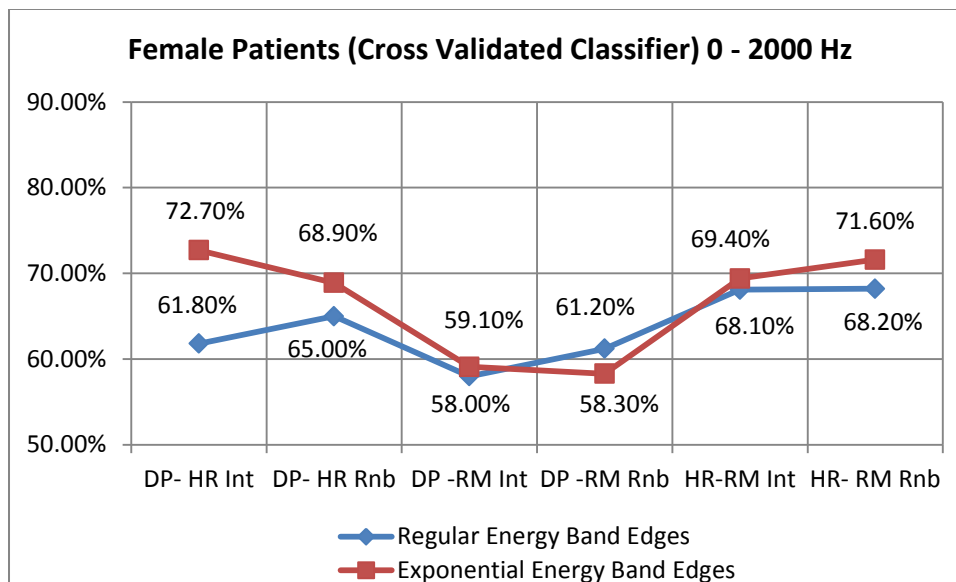

Figure 284: Female Patients’ Results of Exponential Band Edges with Cross Validated Classifier in the 0-2000 Hz Frequency Range

Four exponential edged bands were selected as 0-375 Hz, 375-750 Hz, 750-1500 Hz, 1500-3000 Hz for the 0-3000 Hz frequency range. Figure 285 shows the results with linear classifier; Figure 286 shows the results with the quadratic classifier, and Figure 287 shows the results with the cross validated classifier. In general, none of the pairwise groups gave better results with this band edge modification in the 0-3000 Hz frequency range; therefore, this band edge change in the 0-3000 Hz frequency range didn’t give any optimized energy bands.

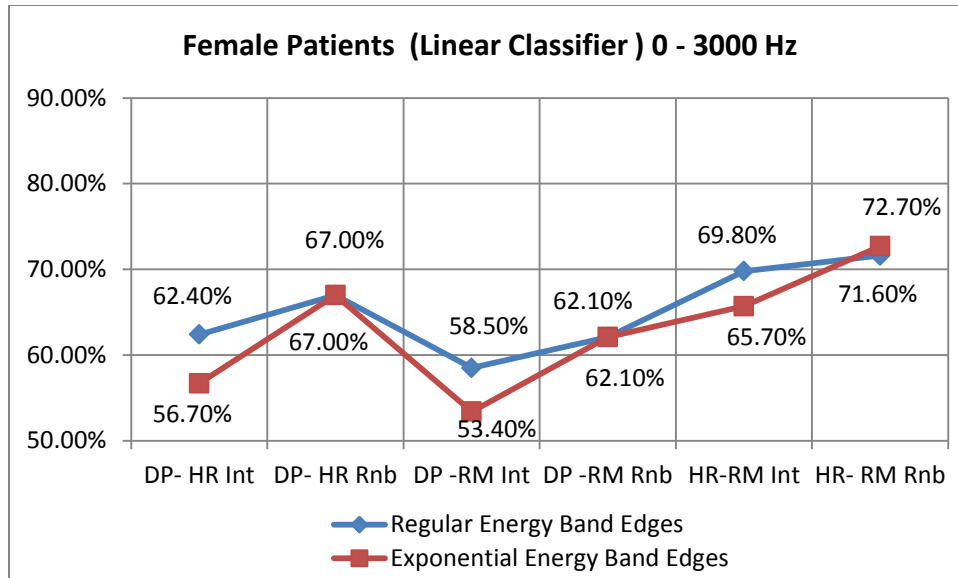

Figure 285: Female Patients' Results of Exponential Band Edges with Linear Classifier in the 0-3000 Hz Frequency Range

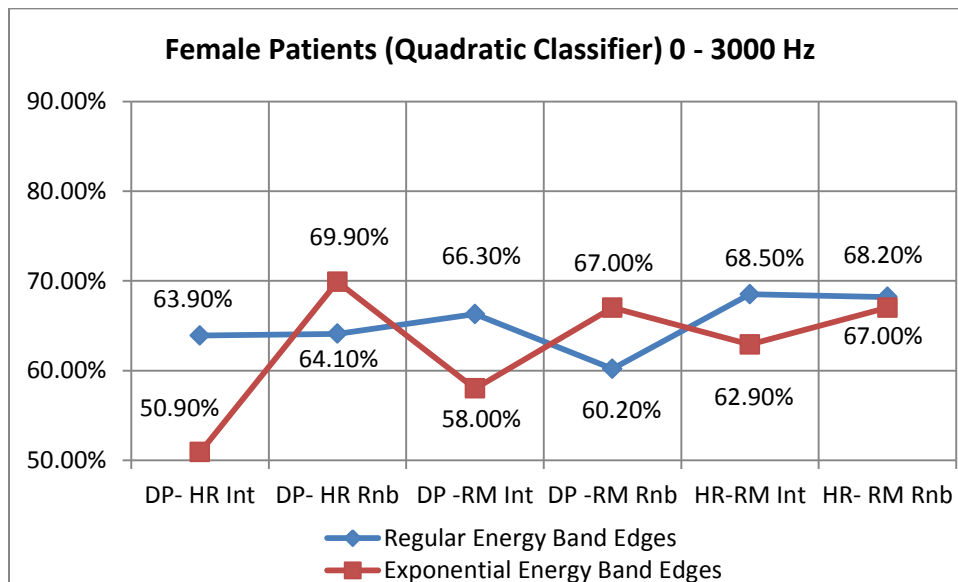

Figure 286: Female Patients' Results of Exponential Band Edges with Quadratic Classifier in the 0-3000 Hz Frequency Range

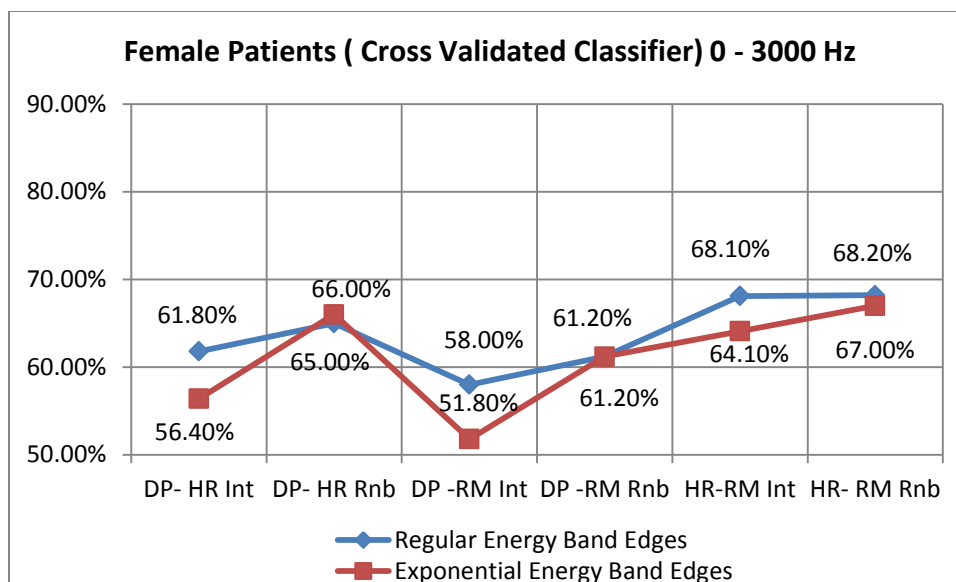

Figure 287: Female Patients’ Results of Exponential Band Edges with Cross Validated Classifier in the 0-3000 Hz Frequency Range

Another way of using the different band edges was using the non-uniform band edges to find optimized energy bands. Instead of regular uniform band edges, non-uniform band edges were used with the 4 band in the 0 – 2000 Hz frequency range. The band edge frequency range was swept in the 0 – 2000 Hz frequency range with 250 Hz frequency increments. Thirty five different combinations of non-uniform energy bands edges were used in the 0 – 2000 Hz frequency range and their classification rates were analyzed for only the Depressed - High Risk Suicidal (DP-HR) pairwise group during both the interview and the reading sessions using the linear and the quadratic classifiers. The best classification rates and associated band edges and energy bands are shown in Table 79. Figure 288 shows the results with linear classifier and Figure 289 shows the results with quadratic classifier. As seen in both figures, the classification rates increased;

so, using the non-uniform band edges in the 0-2000 Hz frequency range could be used to find optimized band edges.

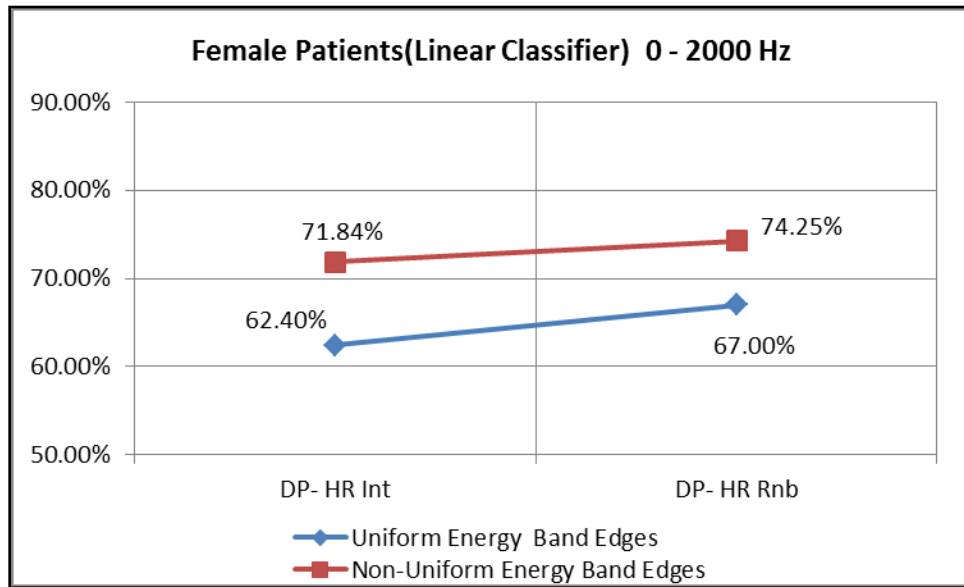

Figure 288: Female Patients' Results of Non-Uniform Band Edges with Linear Classifier in the 0-2000 Hz Frequency Range

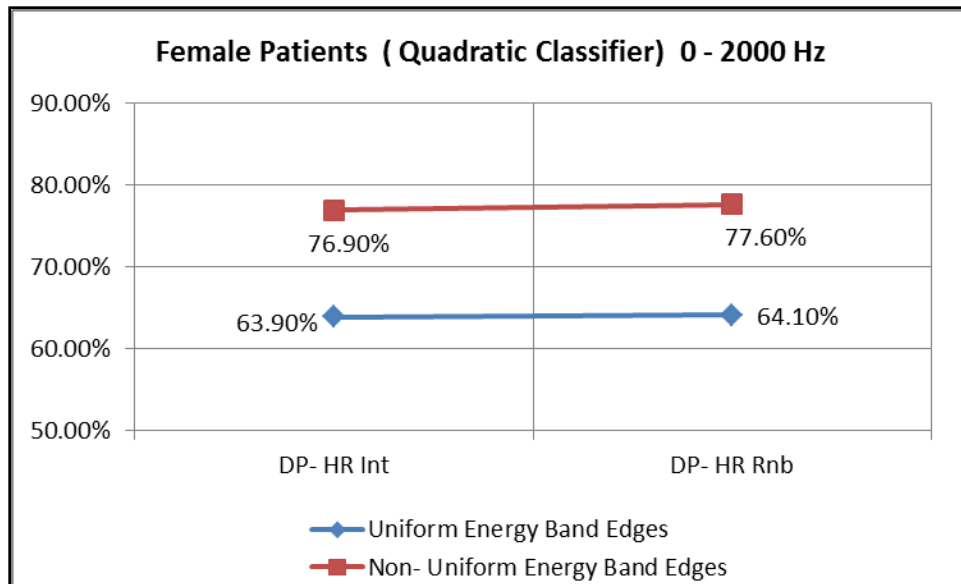

Figure 289: Female Patients’ Results of Non-Uniform Band Edges with Quadratic Classifier in the 0-2000 Hz Frequency Range

One hundred and sixty five different combinations of non-uniform energy bands edges were determined in the 0 – 3000 Hz frequency range by sweeping the 0 – 3000 Hz frequency range with 250 Hz frequency increments and the classification rates for each of these combinations were examined. The best classification rates and associated band edges and energy bands are shown in Table 79. Figure 290 shows the results with the linear classifier and Figure 291 shows the results with quadratic classifier. As seen in both figures, the classification rates increased; therefore, using the non-uniform band edges in the 0-3000 Hz frequency range could be used to find optimized band edges.

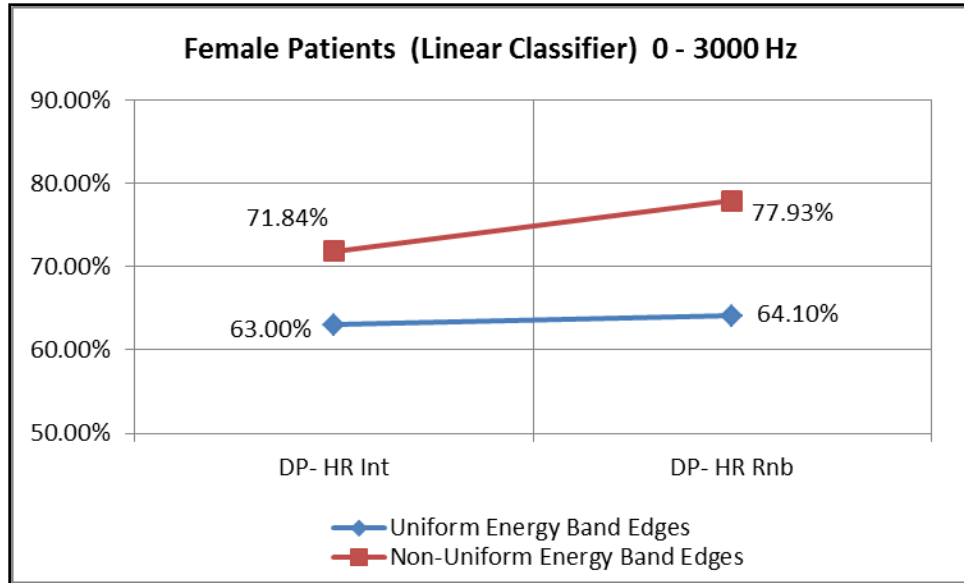

Figure 290: Female Patients' Results of Non-Uniform Band Edges with Linear Classifier in the 0-2000 Hz Frequency Range

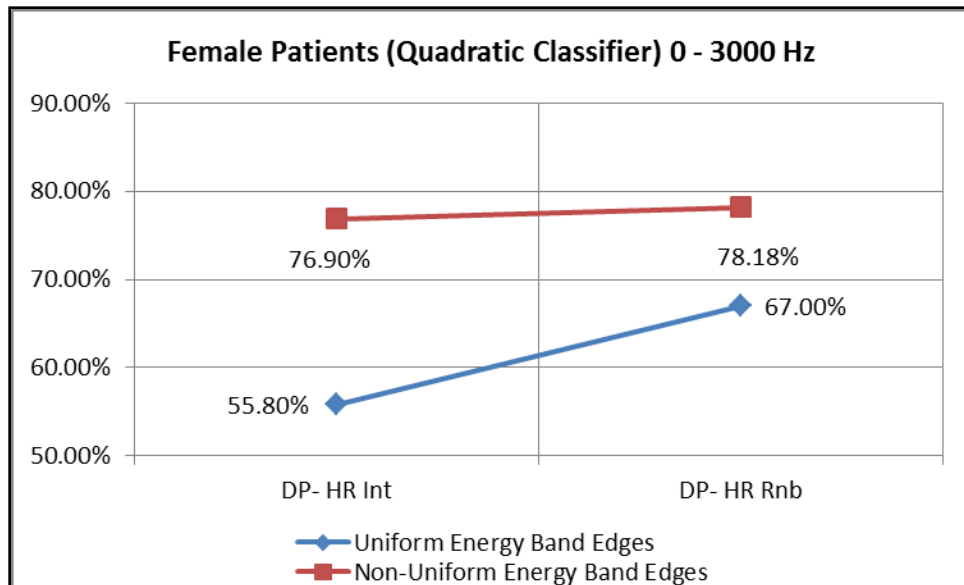

Figure 291: Female Patients' Results of Non-Uniform Band Edges with Quadratic Classifier in the 0-3000 Hz Frequency Range

The table below (Table 83), and the figure below (Figure 292) shows the overall comparison of optimization techniques for the female Depressed- High Risk Suicidal (DP- HR) patients during the interview session.

Table 83: Optimization Results for the Female Patients DP-HR during the Interview Session

	FEMALE DP- HR INTERVIEW		
OPTIMIZATION TECHNIQUES	LINEAR	QUADRATIC	CROSS VALIDATED
Regular Results	62.40%	63.90%	61.80%
Increasing Number of Bands	77.90%	79.40%	77.90%
Increasing Band Range	63.00%	55.80%	61.50%
Increasing Band Number & Range	74.80%	77.30%	73.90%
Exponential Band Edges	72.70%	72.70%	72.70%
Exponential Band Edges & Increase Range	56.70%	50.90%	56.40%
Non-Uniform Band Edges	71.84%	76.90%	N/A
Non-Uniform Band Edges& Increase Range	71.84%	76.90%	N/A

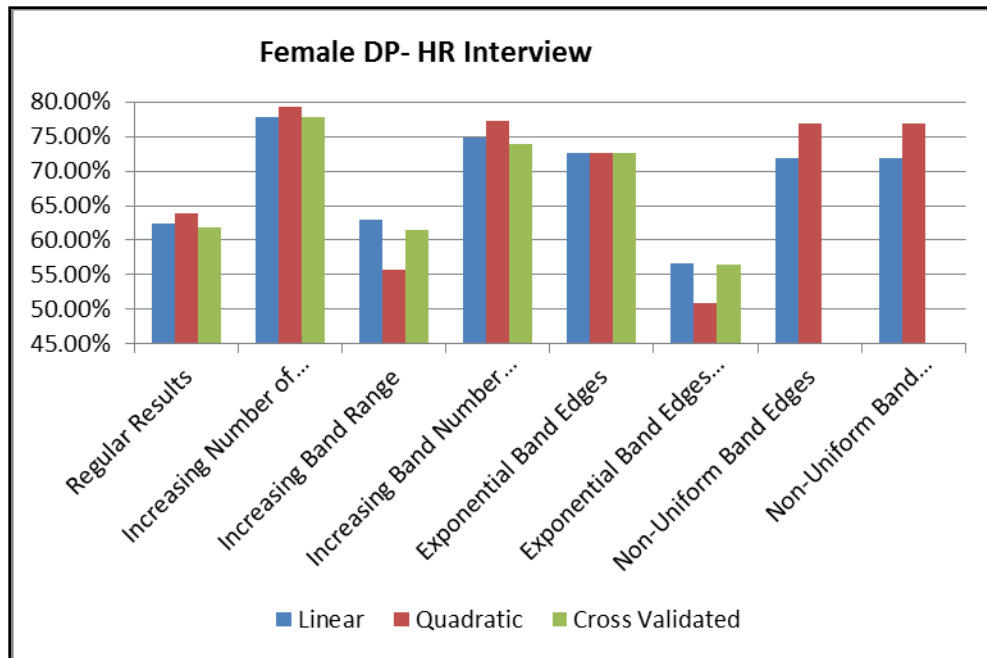

Figure 292: Female DP-HR Interview Session Result Comparison

The table below (Table 84), and the figure below (Figure 293) shows the overall comparison of optimization techniques for the female Depressed- High Risk Suicidal (DP- HR) patients during the reading session.

Table 84: Optimization Results for the Female Patients DP-HR during the Reading Session

	FEMALE DP- HR READING		
OPTIMIZATION TECHNIQUES	LINEAR	QUADRATIC	CROSS VALIDATED
Regular Results	67.00%	64.10%	65.00%
Increasing Number of Bands	76.70%	73.80%	68.90%
Increasing Band Range	64.10%	67.00%	61.20%
Increasing Band Number & Range	78.60%	79.60%	72.80%
Exponential Band Edges	71.80%	68.90%	68.90%
Exponential Band Edges & Increase Range	67.00%	69.90%	66.00%
Non-Uniform Band Edges	74.25%	77.60%	N/A
Non-Uniform Band Edges& Increase Range	77.93%	78.18%	N/A

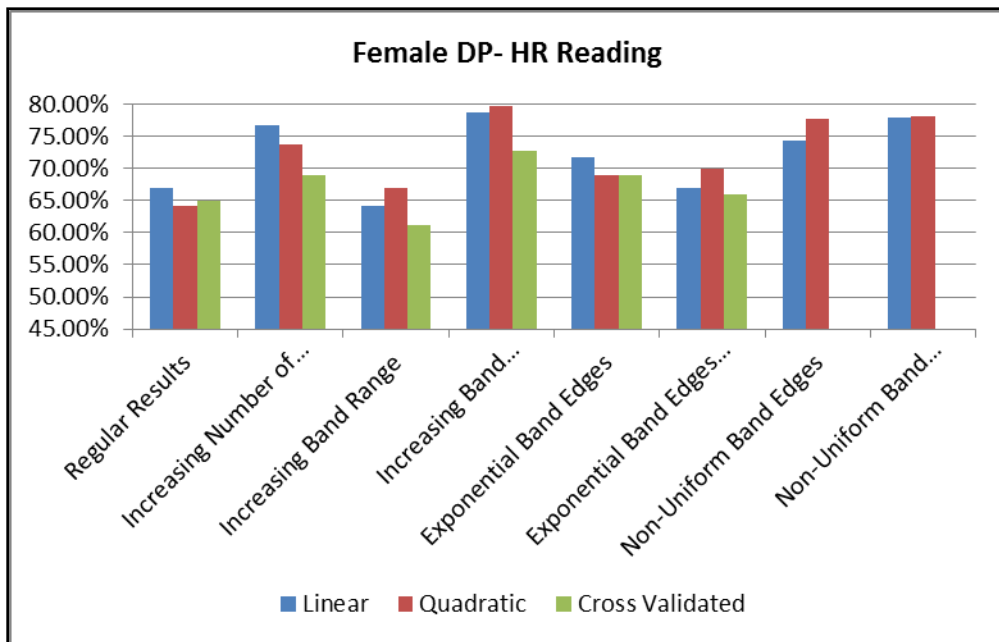

Figure 293: Female DP-HR Reading Session Result Comparison

The table below (Table 85), and the figure below (Figure 294) show the overall comparison of optimization techniques for the female Depressed- Remitted (DP-RM) patients during the interview session.

Table 85: Optimization Results for the Female Patients DP-RM during the Interview Session

OPTIMIZATION TECHNIQUES	FEMALE DP- RM INTERVIEW		
	LINEAR	QUADRATIC	CROSS VALIDATED
Regular Results	58.50%	66.30%	58.00%
Increasing Number of Bands	71.00%	72.50%	69.90%
Increasing Band Range	63.50%	63.00%	63.50%
Increasing Band Number & Range	66.30%	66.30%	65.50%
Exponential Band Edges	60.90%	65.30%	59.10%
Exponential Band Edges & Increase Range	53.40%	58.00%	51.80%
Non-Uniform Band Edges	N/A	N/A	N/A
Non-Uniform Band Edges& Increase Range	N/A	N/A	N/A

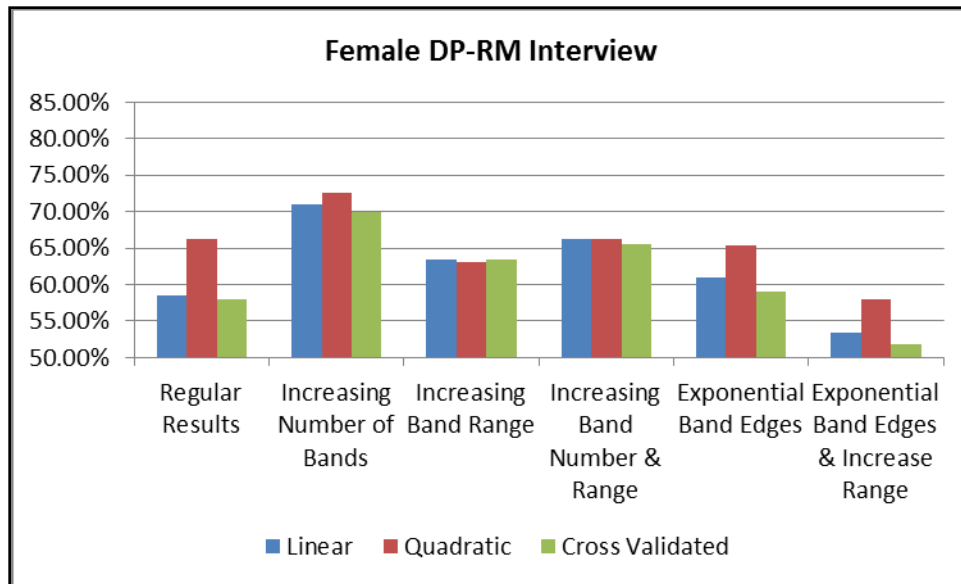

Figure 294: Female DP-RM Interview Session Result Comparison

The table below (Table 86), and the figure below (Figure 295) show the overall comparison of optimization techniques for the female Depressed- Remitted (DP-RM) patients during the reading session.

Table 86: Optimization Results for the Female Patients DP-RM during the Reading Session

	FEMALE DP- RM READING		
OPTIMIZATION TECHNIQUES	LINEAR	QUADRATIC	CROSS VALIDATED
Regular Results	62.10%	60.20%	61.20%
Increasing Number of Bands	76.70%	77.70%	74.80%
Increasing Band Range	67.00%	62.10%	64.10%
Increasing Band Number & Range	80.60%	82.50%	79.60%
Exponential Band Edges	62.10%	63.10%	58.30%
Exponential Band Edges & Increase Range	62.10%	67.00%	61.20%
Non-Uniform Band Edges	N/A	N/A	N/A
Non-Uniform Band Edges& Increase Range	N/A	N/A	N/A

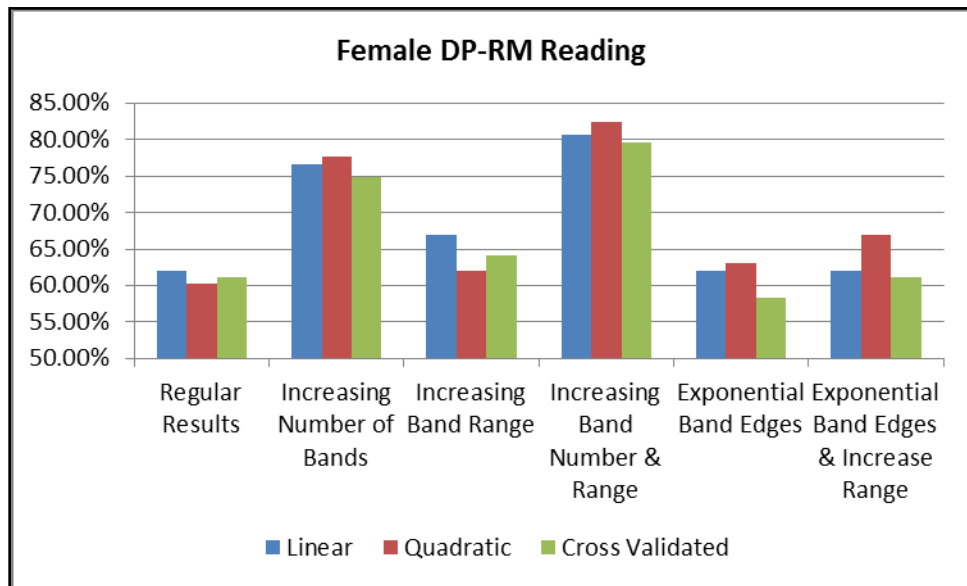

Figure 295: Female DP-RM Reading Session Result Comparison

The table below (Table 87), and the figure below (Figure 296) show the overall comparison of optimization techniques for the female High Risk Suicidal – Remitted (HR-RM) patients during the interview session.

Table 87: Optimization Results for the Female Patients HR-RM during the Interview Session

	FEMALE HR- RM INTERVIEW		
OPTIMIZATION TECHNIQUES	LINEAR	QUADRATIC	CROSS VALIDATED
Regular Results	69.80%	68.50%	68.10%
Increasing Number of Bands	79.40%	79.00%	76.60%
Increasing Band Range	62.50%	53.60%	61.30%
Increasing Band Number & Range	77.40%	76.60%	75.40%
Exponential Band Edges	70.20%	68.10%	69.40%
Exponential Band Edges & Increase Range	65.70%	62.90%	64.10%
Non-Uniform Band Edges	N/A	N/A	N/A
Non-Uniform Band Edges& Increase Range	N/A	N/A	N/A

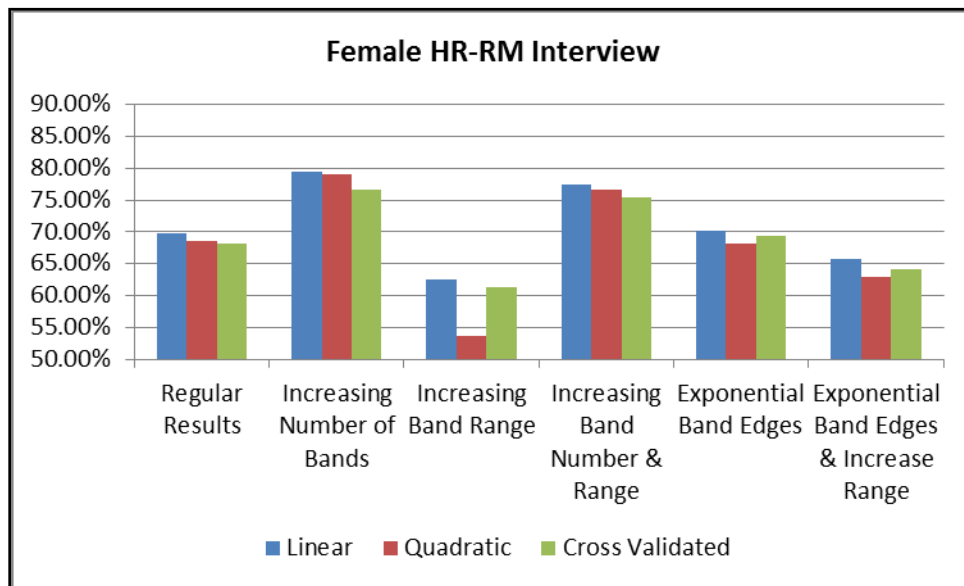

Figure 296: Female HR-RM Interview Session Result Comparison

The table below (Table 88), and the figure below (Figure 297) show the overall comparison of optimization techniques for the female High Risk Suicidal – Remitted (HR-RM) patients during the reading session.

Table 88: Optimization Results for the Female Patients HR-RM during the Reading Session

OPTIMIZATION TECHNIQUES	FEMALE HR- RM READING		
	LINEAR	QUADRATIC	CROSS VALIDATED
Regular Results	71.60%	68.20%	68.20%
Increasing Number of Bands	87.50%	87.50%	83.00%
Increasing Band Range	68.20%	68.20%	63.60%
Increasing Band Number & Range	85.20%	84.10%	80.70%
Exponential Band Edges	75.00%	75.00%	71.60%
Exponential Band Edges & Increase Range	72.70%	67.00%	67.00%
Non-Uniform Band Edges	N/A	N/A	N/A
Non-Uniform Band Edges& Increase Range	N/A	N/A	N/A

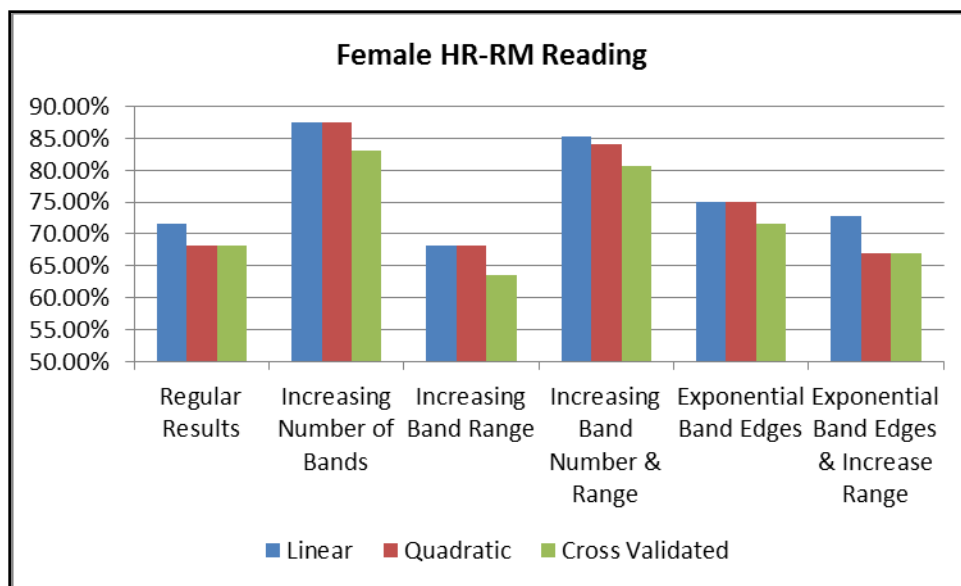

Figure 297: Female HR-RM Reading Session Result Comparison

In conclusion, the table below (Table 89) shows all the overall optimization results for the female patients using the linear classifier. Table 90 shows the overall optimization results with using the quadratic classifier and Table 91 shows the overall optimization results with using the cross validated classifier. In the tables below, the tick symbol denotes that a corresponding optimization technique resulted in optimized energy bands with higher classification rates than regular energy bands (4 bands in 0-2000 Hz). On the other hand, the cross symbol denotes the opposite.

Table 89: Optimization Results for the Female Patients Using the Linear Classifier

LINEAR CLASSIFIER	FEMALE PAIRWISE GROUPS					
	DP - HR Int	DP - HR Rnb	DP - RM Int	DP - RM Rnb	HR-RM Int	HR-RM Rnb
Optimization Techniques						
Increasing Number of Bands	✓	✓	✓	✓	✓	✓
Increasing Band Range	✗	✗	✓	✓	✗	✗
Increasing Band Number & Range	✓	✓	✓	✓	✓	✓
Exponential Band Edges	✓	✓	✓	✗	✗	✓
Exponential Band Edges & Increase Range	✗	✗	✗	✗	✗	✓
Non-Uniform Band Edges	✓	✓	N/A	N/A	N/A	N/A
Non-Uniform Band Edges& Increase Range	✓	✓	N/A	N/A	N/A	N/A

Table 90: Optimization Results for the Female Patients Using the Quadratic Classifier

QUADRATIC CLASSIFIER	FEMALE PAIRWISE GROUPS					
	DP - HR Int	DP - HR Rnb	DP - RM Int	DP - RM Rnb	HR-RM Int	HR-RM Rnb
Optimization Techniques						
Increasing Number of Bands	✓	✓	✓	✓	✓	✓
Increasing Band Range	✗	✓	✗	✓	✗	✗
Increasing Band Number & Range	✓	✓	✗	✓	✓	✓
Exponential Band Edges	✓	✓	✗	✓	✗	✓
Exponential Band Edges & Increase Range	✗	✓	✗	✓	✗	✗
Non-Uniform Band Edges	✓	✓	N/A	N/A	N/A	N/A
Non-Uniform Band Edges& Increase Range	✓	✓	N/A	N/A	N/A	N/A

Table 91: Optimization Results for the Female Patients Using the Cross Validated Classifier

CROSS VALIDATED CLASSIFIER	FEMALE PAIRWISE GROUPS					
	DP - HR Int	DP - HR Rnb	DP - RM Int	DP - RM Rnb	HR-RM Int	HR-RM Rnb
Optimization Techniques						
Increasing Number of Bands	✓	✓	✓	✓	✓	✓
Increasing Band Range	✗	✗	✓	✓	✗	✗
Increasing Band Number & Range	✓	✓	✓	✓	✓	✓
Exponential Band Edges	✓	✓	✓	✗	✓	✓
Exponential Band Edges & Increase Range	✗	✗	✗	✗	✗	✗
Non-Uniform Band Edges	✓	✓	N/A	N/A	N/A	N/A
Non-Uniform Band Edges& Increase Range	✓	✓	N/A	N/A	N/A	N/A

The Depressed- High Risk Suicidal pairwise group is the most important and critical pairwise group with regard to avoid deaths from the suicide attempts. If the high risk suicidal patients can be discriminated successfully from the depressed patients afterwards deaths from the suicides will be lowered. For female patients of the Depressed - High Risk Suicidal pairwise group during the interview session (DP-HR Int), all of the optimization techniques gave good results except for increasing the band range (from the 0-2000 Hz to the 0-3000 Hz) and exponential band edges with increased band range. This was observed with all three classifiers (linear, quadratic and cross validated). The classification rate is increased with increasing the number of bands technique (24.84% → linear, 24.26% → quadratic, 26.05% → cross validated), with increasing the number of bands & range (19.87% → linear, 20.97% → quadratic, 19.58% → cross validated), with the exponential band edges (16.51% → linear, 13.77% → quadratic, 17.64% → cross validated), with the non-uniform band edges (15.13% → linear, 20.34% → quadratic) and with the non-uniform band edges & increased range (15.13% → linear, 20.34% → quadratic). During the reading session (DP-HR Rnb), the same conclusion was observed with the linear and cross validated classifiers. But with the quadratic classifier, all of the optimization techniques worked well and gave better classification rates after the optimization techniques. The classification rate is increased with increasing the number of bands technique (14.48% → linear, 15.13% → quadratic, 6.00% → cross validated), with increasing the band range (4.52% → quadratic), with increasing the number of bands & range (17.31% → linear, 24.18% → quadratic, 12.00% → cross validated), with the exponential band edges (7.16% → linear, 7.49% → quadratic, 6.00% → cross validated), with the exponential band edges & increase range (9.05% → quadratic), with the non-

uniform band edges (10.82% → linear, 21.06% → quadratic) and with the non-uniform band edges & increase range (16.31% → linear, 21.96% → quadratic).

For the female patients of the Depressed - Remitted pairwise group during the interview session (DP-RM Int), all of the available optimization techniques gave good results except the exponential band edges with increased band ranges with the linear and cross validated classifiers. With the quadratic classifier, only increasing the number of bands technique gave better classification rates. So, for this classifier only increasing the number of bands is an optimal technique. The classification rate is increased with increasing the number of bands technique (21.37% → linear, 9.35% → quadratic, 20.52% → cross validated), with increasing the band range (8.55% → linear, 9.48% → cross validated), with increasing the number of bands & range (13.33% → linear, 12.93% → cross validated), with the exponential band edges (4.10% → linear, 1.90% → cross validated). During the reading session (DP-RM Rnb), all of the available optimization techniques increased the classification rates with the quadratic classifier. But with the other two classifiers, only three optimization techniques worked well and gave better classification rates. These are increasing the number of bands, increasing band range, and increasing band number & range optimization techniques. The classification rate is increased with increasing the number of bands technique (23.51% → linear, 29.07% → quadratic, 22.22% → cross validated), with increasing the band range (7.89% → linear, 3.16 → quadratic, 4.74 → cross validated), with increasing the number of bands & range (29.79% → linear, 37.04% → quadratic, 30.06% → cross validated), with the exponential band edges (4.82% → quadratic), with the exponential band edges & increase range (11.29% → quadratic).

For the female patients of the High Risk Suicidal - Remitted pairwise group during the interview session (HR-RM Int), only increasing the number of bands and increasing the band number & range are the optimization techniques that gave good results with the linear and quadratic classifiers. With the cross validated classifier, these two techniques and exponential band edges techniques are found to give better classification rates. The classification rate is increased with increasing the number of bands technique (13.75% → linear, 15.33% → quadratic, 12.48% → cross validated), with increasing the number of bands & range (10.89% → linear, 11.82% → quadratic, 10.72% → cross validated), and with the exponential band edges (1.91% → cross validated). For the reading session (HR-RM Rnb), all of the available optimization techniques gave better classification results except for increasing the band range technique with the linear classifier. With the quadratic and cross validated classifiers, all of the available optimization techniques gave better classification results except for increasing the band range technique and the exponential band edges & the increased range technique. The classification rate is increased with increasing the number of bands technique (22.21% → linear, 28.30% → quadratic, 21.70% → cross validated), with increasing the number of bands & range (18.99% → linear, 23.31% → quadratic, 18.33% → cross validated), with the exponential band edges (4.75% → linear, 9.97% → quadratic, , 4.98% → cross validated), and with the exponential band edges & increased range (1.54% → linear).

5.2 Discussion and Conclusion for the Male Patients

All of the male patients' classification rates were also increased, when the number of energy bands was increased using the linear classifier. Using the quadratic classifier, only the Depressed – Remitted (DP-RM) reading session gave the same result with both the analyses and using the cross validated classifier Depressed – Remitted (DP-RM) interview session gave the same result with both of the analyses. Figure 298 below shows the results for the linear classifier, Figure 299 shows the results with the quadratic classifier and finally Figure 300 shows the results with the cross validated classifier. So, we can conclude that increasing the number of energy bands is a good way to optimize the energy bands for the male patients. This technique didn't give better results with the DP-RM interview and the DP-RM reading data using the quadratic and cross validated classifiers.

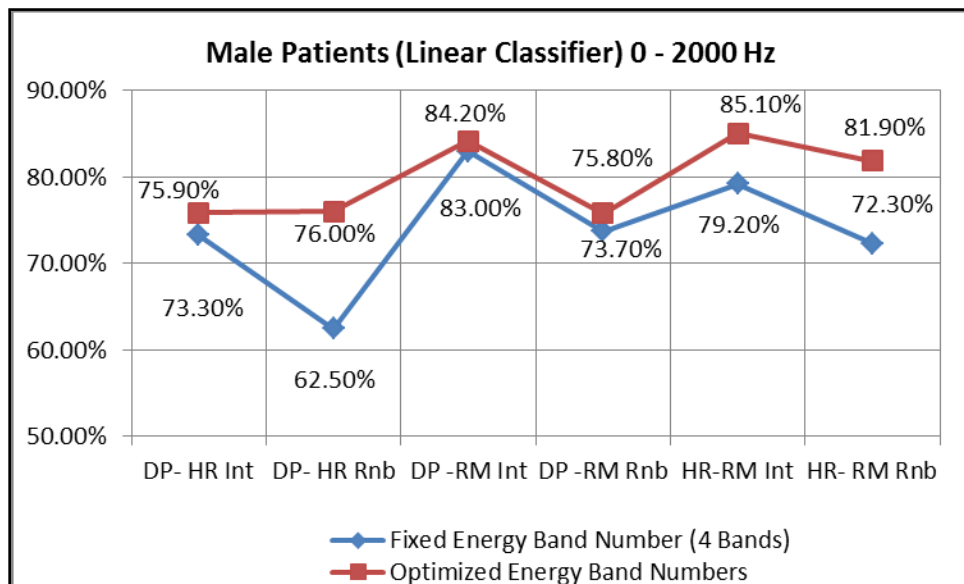

Figure 298: Male Patients' Results Comparison with Linear Classifier

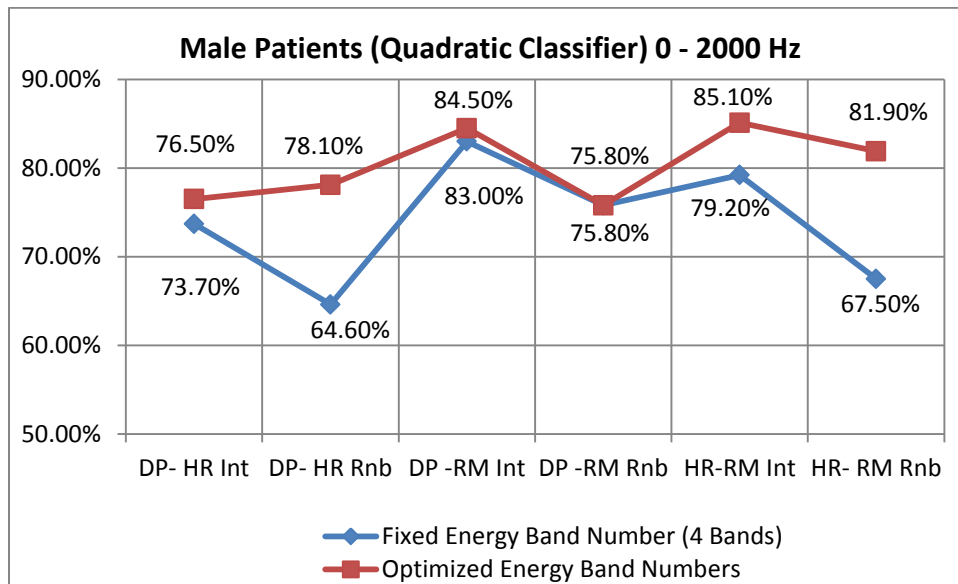

Figure 299: Male Patients' Results Comparison with Quadratic Classifier

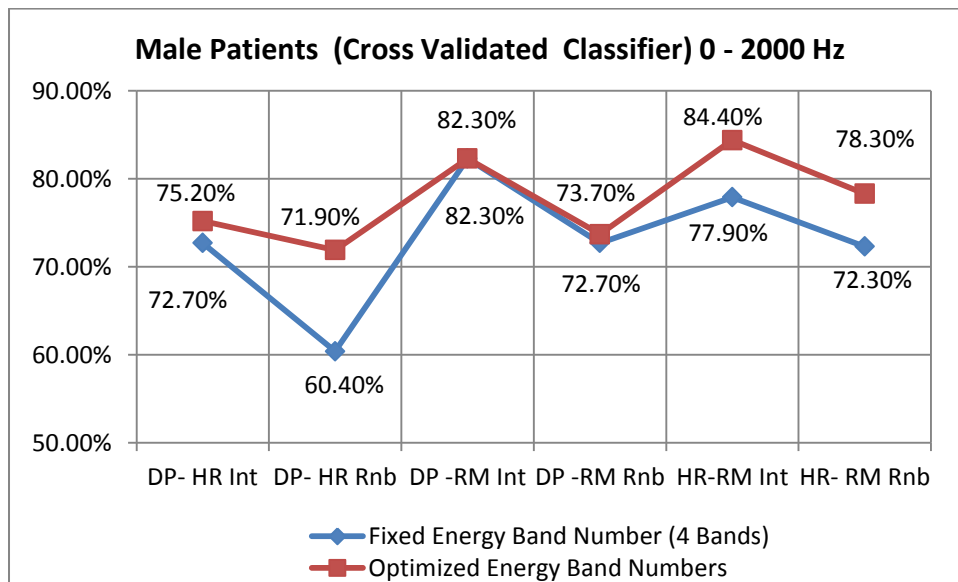

Figure 300: Male Patients' Results Comparison with Cross Validated Classifier

Increasing the band range from the 0-2000 Hz to the 0-3000 Hz with having 4 fixed energy bands were another optimization technique that has been analyzed. All of the pairwise groups except for the DP-RM interview and the DP-RM reading groups gave better results when the frequency range is increased to the 0-3000 Hz using the linear classifier. This can be observed in Figure 301.

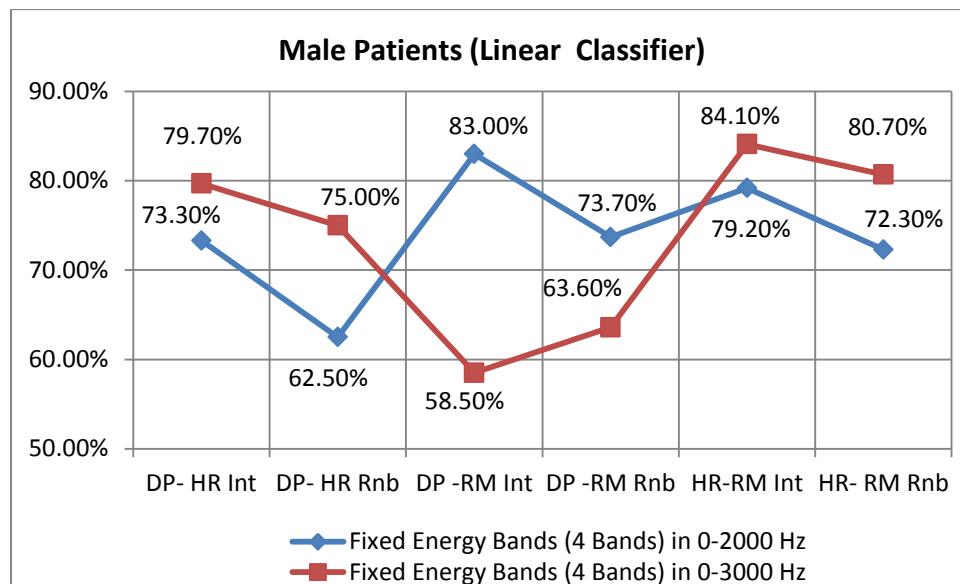

Figure 301: Male Patients' Different Frequency Ranges Results with Linear Classifier

All of the pairwise groups except for the DP-RM interview and the DP-RM reading groups gave better results when the frequency range was increased to the 0-3000 Hz using the quadratic classifier and the cross validated classifier. These results can be observed in Figure 302 and Figure 303 below. So, it can be concluded that increasing the frequency range from the 0-2000 Hz to the 0-3000 Hz gave better results and this

modification give the optimized energy bands for the male patients except for the DP-RM pairwise group (both the interview and the reading sessions).

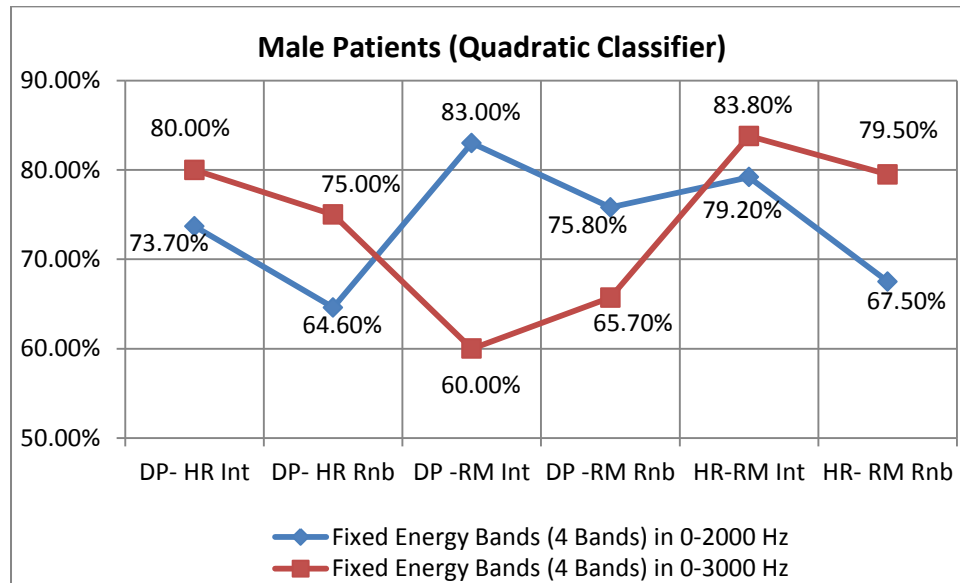

Figure 302: Male Patients' Different Frequency Ranges Results with Quadratic Classifier

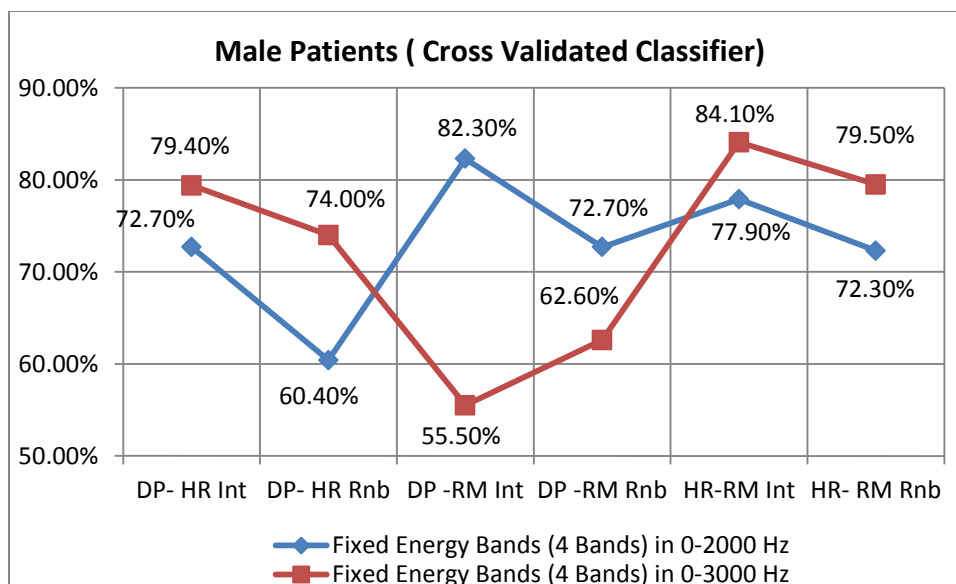

Figure 303: Male Patients’ Different Frequency Ranges Results with Cross Validated Classifier

For the male patients, increasing the number of energy bands was also applied to the 0-3000 Hz frequency range and how the classification rates are affected with this change were also analyzed. Afterwards, the results of 4 fixed energy bands in the 0-2000 Hz range and the results from increasing the number of bands in the 0-3000 Hz frequency range were compared. Figure 304 shows the results using the linear classifier, Figure 305 shows the results with using the quadratic classifier, and Figure 306 shows the results from the cross validated classifier. When the number of energy bands was increased in the new frequency range of the 0-3000 Hz, the male patients’ classification rates were also increased except for the DP-RM interview session and the DP-RM reading session. So, we can conclude that increasing the number of energy bands in the new frequency range of the 0-3000 Hz is also good way to optimize the energy bands for the male

patients except for the DP-RM pairwise group (for both the interview and the reading session).

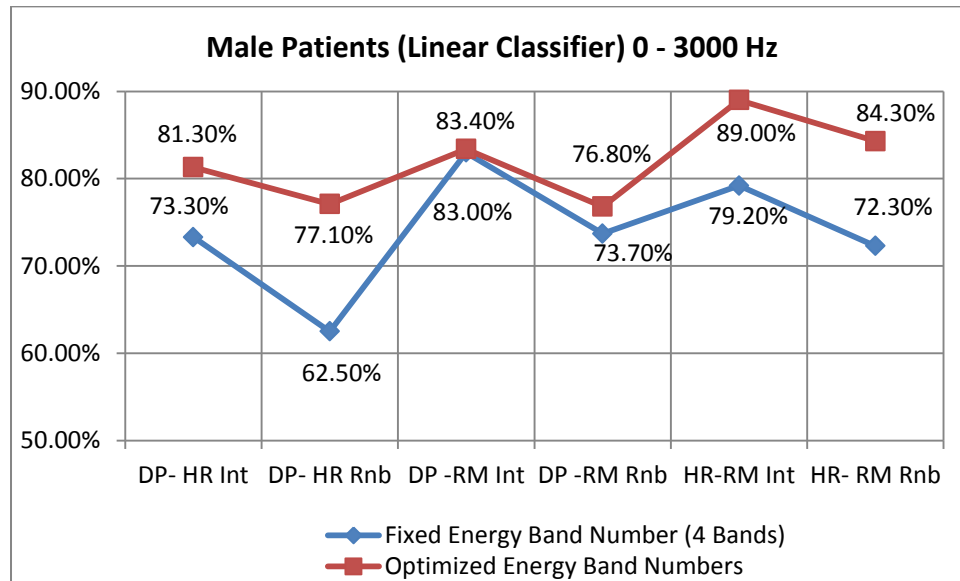

Figure 304: Male Patients' Results Comparison with Linear Classifier in the 0-3000 Hz Frequency Range

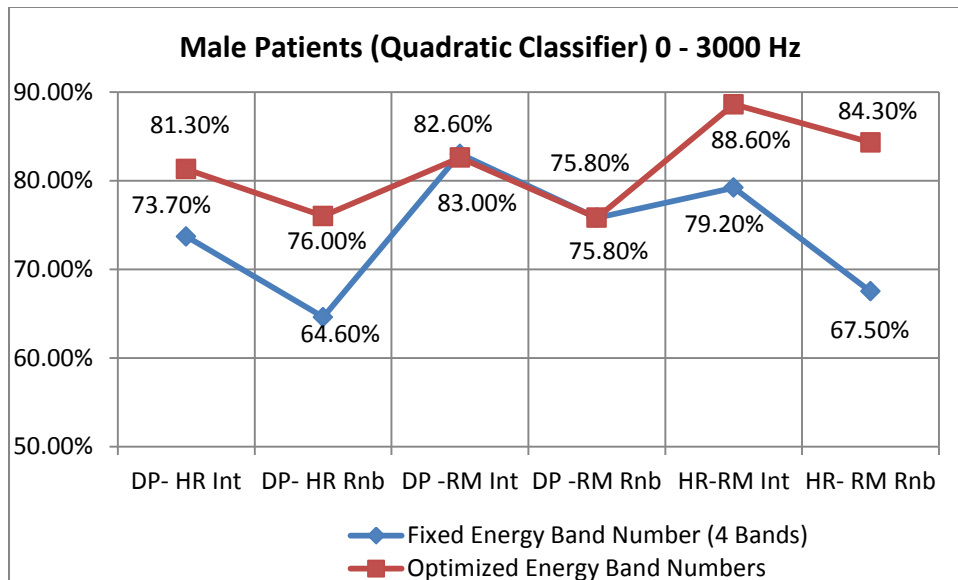

Figure 305: Male Patients' Results Comparison with Quadratic Classifier in the 0-3000 Hz Frequency Range

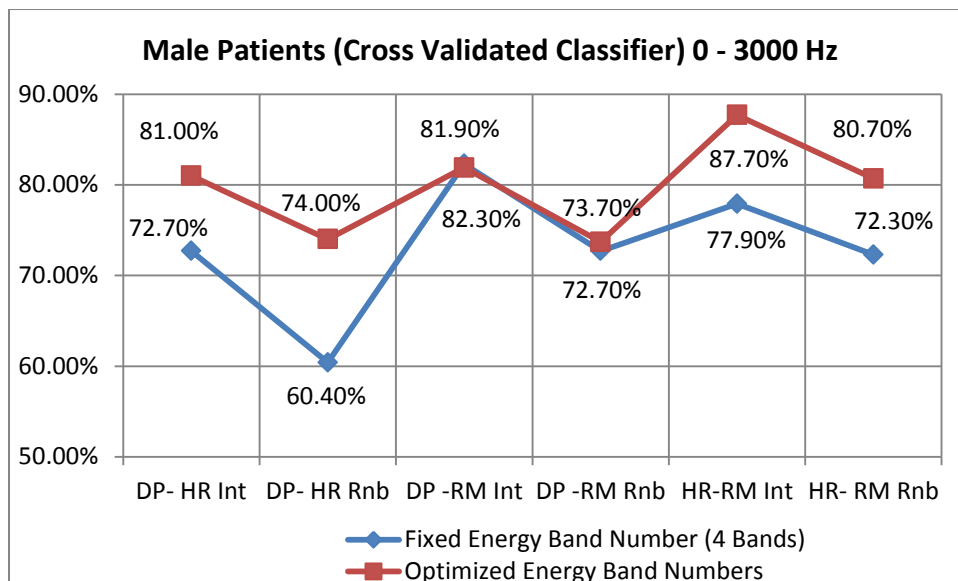

Figure 306: Male Patients' Results Comparison with Cross Validated Classifier in the 0-3000 Hz Frequency Range

For the male patients, the exponential band edges were also analyzed with 4 bands in the 0 – 2000 Hz frequency range. Four exponential edged bands were selected as the 0 -250 Hz, 250-500 Hz, 500-1000 Hz and 1000-2000 Hz for the 0-2000 Hz frequency range. Only the Depressed - High Risk Suicidal (DP-HR) pairwise group during the reading session gave better results with exponential band edges in the 0-2000 Hz frequency range. Figure 307 shows the results with the linear classifier; Figure 308 shows the results with the quadratic classifier, Figure 309 shows the results with the cross validated classifier. So, the exponential band edges are the optimized energy bands only for the DP-HR pairwise group during the reading session in the 0-2000 Hz frequency range for the male patients.

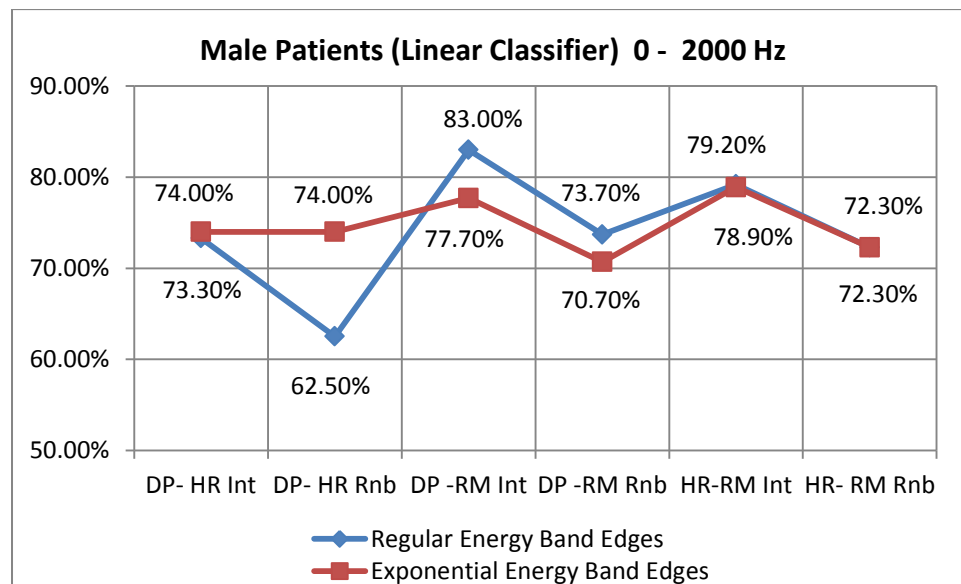

Figure 307: Male Patients' Results of Exponential Band Edges with Linear Classifier in the 0-2000 Hz Frequency Range

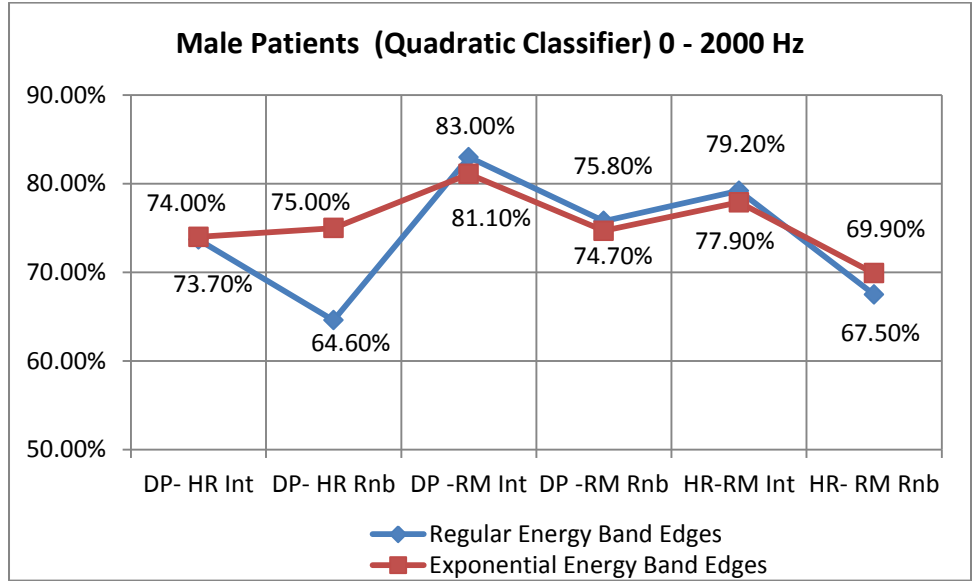

Figure 308: Male Patients' Results of Exponential Band Edges with Quadratic Classifier in the 0-2000 Hz Frequency Range

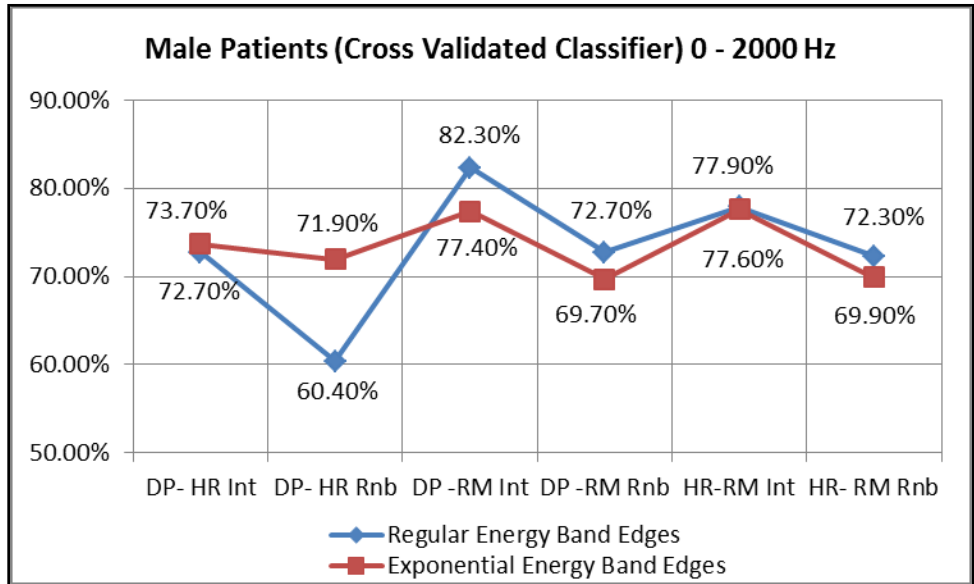

Figure 309: Male Patients' Results of Exponential Band Edges with Cross Validated Classifier in the 0-2000 Hz Frequency Range

Four exponential edged bands were selected as the 0-375 Hz, 375-750 Hz, 750-1500 Hz, and 1500-3000 Hz for the 0-3000 Hz frequency range for the male patients. Figure 310 shows the results with the linear classifier; Figure 311 shows the results with the quadratic classifier, Figure 312 shows the results with the cross validated classifier. All of the pairwise groups except the DP-RM interview session and the DP-RM reading session gave better results with this band edge modification in the 0-3000 Hz frequency range; therefore, this band edge change in the 0-3000 Hz frequency range created optimized energy bands for all the pairwise groups except the Depressed - Remitted (DP-RM) pairwise group for the male patients.

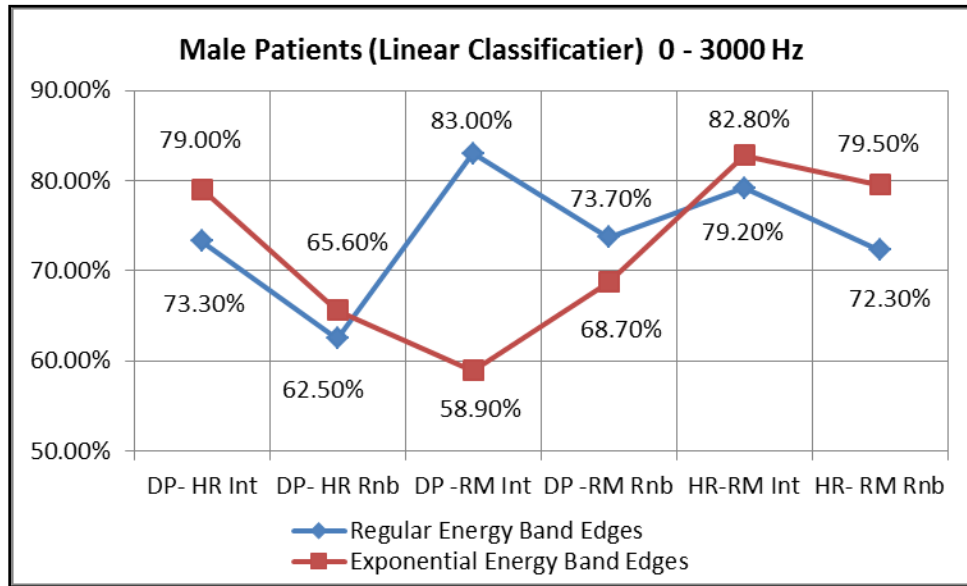

Figure 310: Male Patients' Results of Exponential Band Edges with Linear Classifier in the 0-3000 Hz Frequency Range

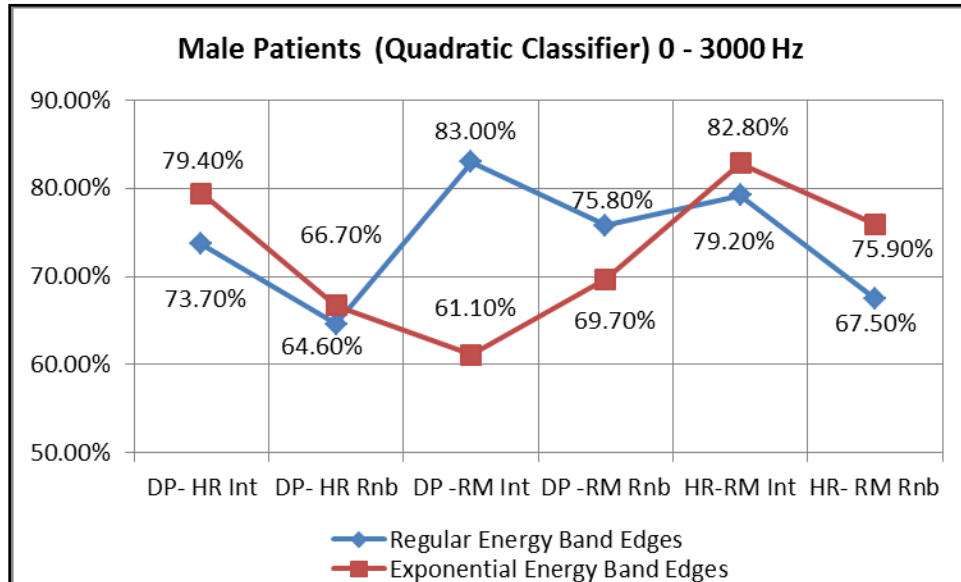

Figure 311: Male Patients' Results of Exponential Band Edges with Quadratic Classifier in the 0-3000 Hz Frequency Range

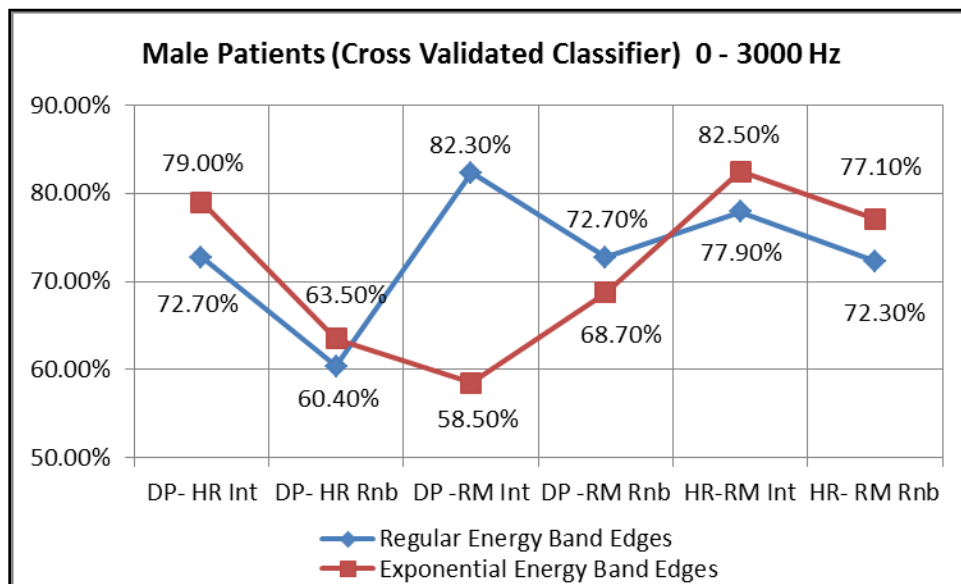

Figure 312: Male Patients' Results of Exponential Band Edges with Cross Validated Classifier in the 0-3000 Hz Frequency Range

For the male patients, the non-uniform band edges study was also applied with 4 bands in the 0 – 2000 Hz frequency range by sweeping between the 0 – 2000 Hz frequency range with the 250 Hz frequency increments. Thirty five different combinations of non-uniform energy bands edges were used in the 0 – 2000 Hz frequency range and their classification rates were analyzed only for the Depressed - High Risk Suicidal (DP-HR) pairwise group during both the interview and the reading sessions using the linear and the quadratic classifiers. The best classification rates and the associated band edges and energy bands are shown in Table 82. Figure 313 shows the results with the linear classifier and Figure 314 shows the results with the quadratic classifier. As seen in both figures, the classification rates increased; therefore, using non-uniform band edges in the 0-2000 Hz frequency range gives optimized energy bands for male patients.

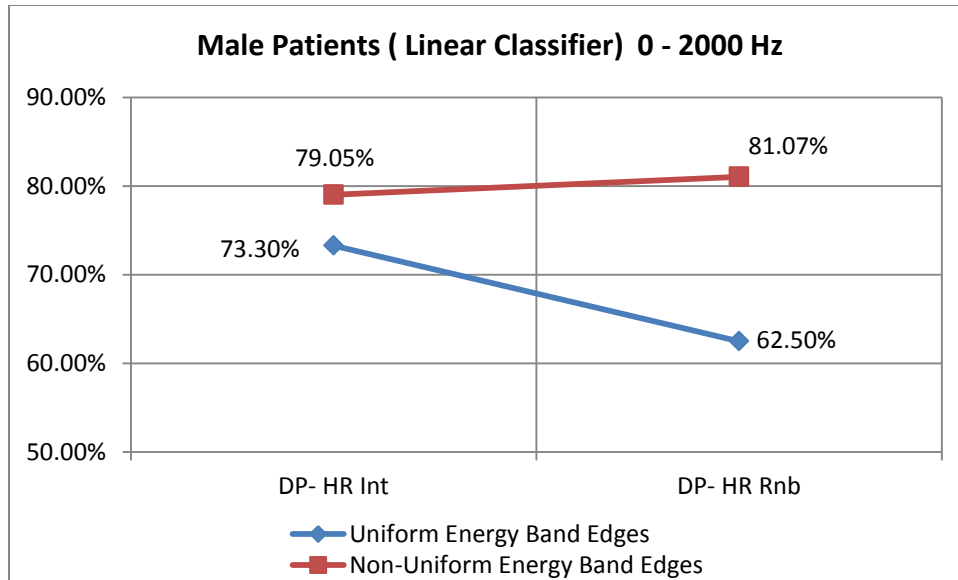

Figure 313: Male Patients' Results of Non-Uniform Band Edges with Linear Classifier in the 0-2000 Hz Frequency Range

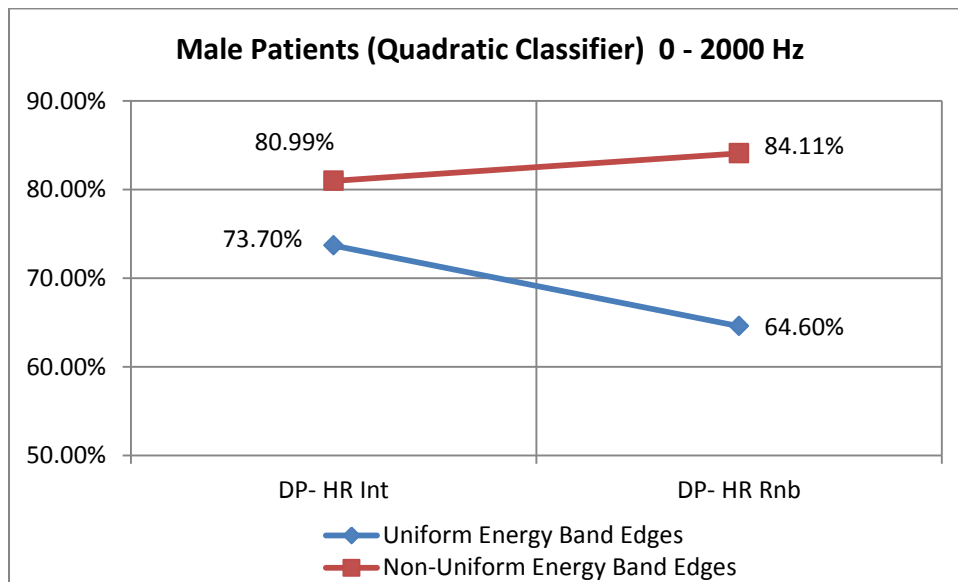

Figure 314: Male Patients' Results of Non-Uniform Band Edges with Quadratic Classifier in the 0-2000 Hz Frequency Range

One hundred and sixty five different combinations of the non-uniform energy bands edges were determined in the 0 – 3000 Hz frequency range by sweeping the 0 – 3000 Hz frequency range with the 250 Hz frequency increments and the classification rates for each of these combinations were examined for the male patients. The best classification rates and the associated band edges and the energy bands are shown in Table 82. Figure 315 shows the results with the linear classifier and Figure 316 shows the results with the quadratic classifier. As seen in both figures, the classification rates increased; hence, using the non-uniform band edges in the 0-3000 Hz frequency range could be used to find optimized band edges for the male patients.

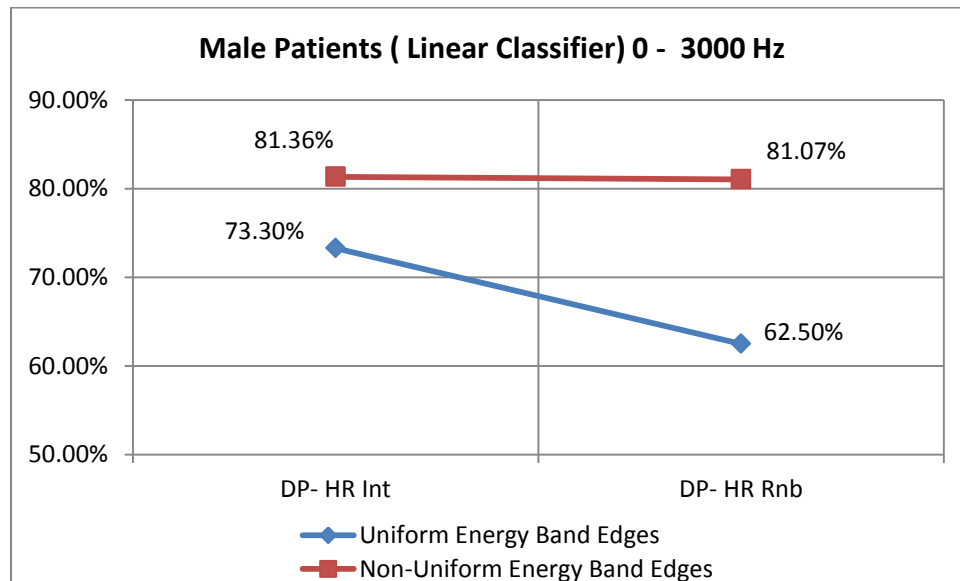

Figure 315: Male Patients’ Results of Non-Uniform Band Edges with Linear Classifier in the 0-2000 Hz Frequency Range

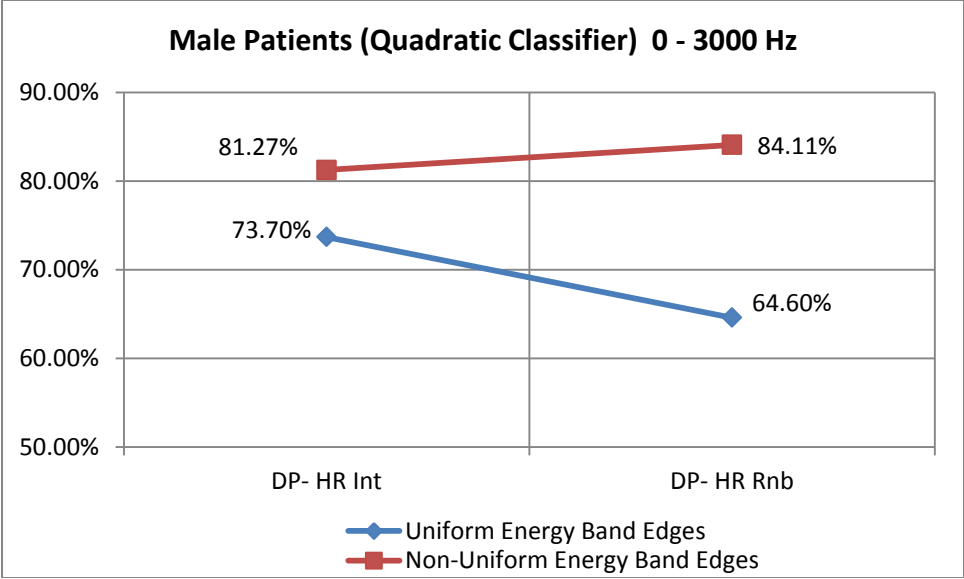

Figure 316: Male Patients’ Results of Non-Uniform Band Edges with Quadratic Classifier in the 0-3000 Hz Frequency Range

The table below (Table 92), and the figure below (Figure 317) show the overall comparison of optimization techniques for the male Depressed- High Risk Suicidal (DP-HR) patients during the interview session.

Table 92: Optimization Results for the Male Patients DP-HR during the Interview Session

	MALE DP- HR INTERVIEW		
OPTIMIZATION TECHNIQUES	LINEAR	QUADRATIC	CROSS VALIDATED
Regular Results	73.30%	73.70%	72.70%
Increasing Number of Bands	75.90%	76.50%	75.20%
Increasing Band Range	79.70%	80.00%	79.40%
Increasing Band Number & Range	81.30%	81.30%	81.00%
Exponential Band Edges	74.00%	74.00%	73.70%
Exponential Band Edges & Increase Range	79.00%	79.40%	79.00%
Non-Uniform Band Edges	79.05%	80.99%	N/A
Non-Uniform Band Edges& Increase Range	81.36%	81.27%	N/A

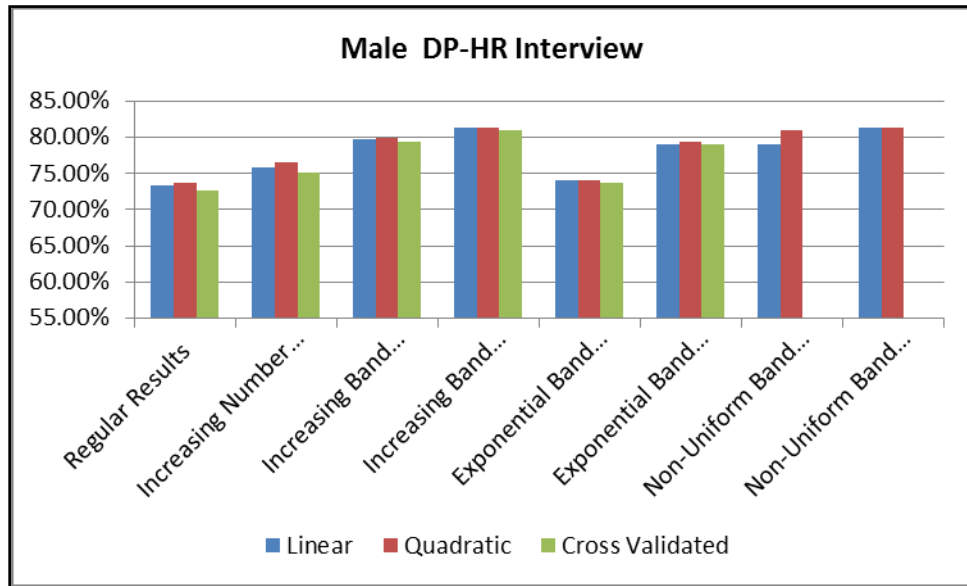

Figure 317: Male DP-HR Interview Session Result Comparison

The table below (Table 93), and the figure below (Figure 318) show the overall comparison of the optimization techniques for the male Depressed- High Risk Suicidal (DP- HR) patients during the reading session.

Table 93: Optimization Results for the Male Patients DP-HR during the Reading Session

	MALE DP- HR READING		
OPTIMIZATION TECHNIQUES	LINEAR	QUADRATIC	CROSS VALIDATED
Regular Results	62.50%	64.60%	60.40%
Increasing Number of Bands	76.00%	78.10%	71.90%
Increasing Band Range	75.00%	75.00%	74.00%
Increasing Band Number & Range	77.10%	76.00%	74.00%
Exponential Band Edges	74.00%	75.00%	71.90%
Exponential Band Edges & Increase Range	65.60%	66.70%	63.50%
Non-Uniform Band Edges	81.07%	84.11%	N/A
Non-Uniform Band Edges& Increase Range	81.07%	84.11%	N/A

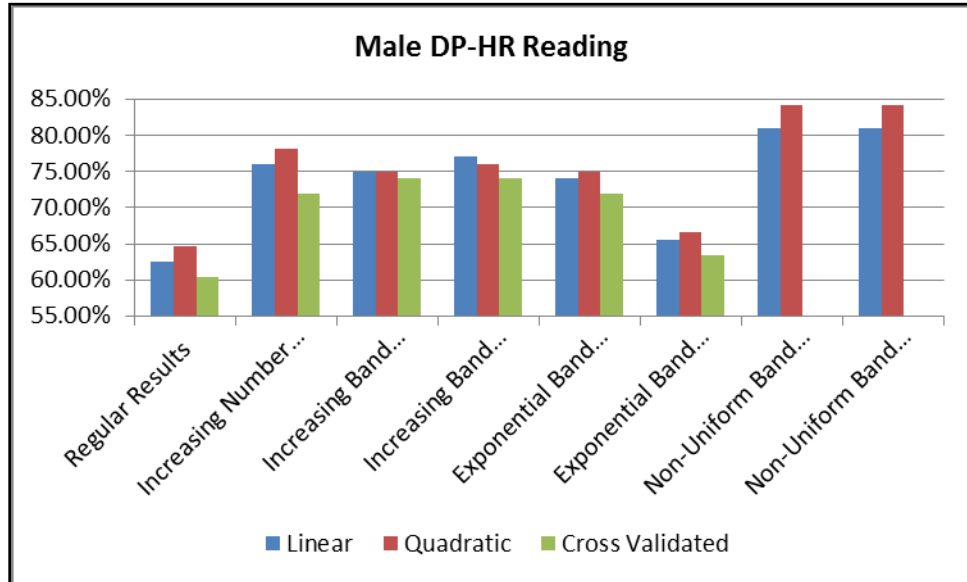

Figure 318: Male DP-HR Reading Session Result Comparison

The table below (Table 94), and the figure below (Figure 319) show the overall comparison of the optimization techniques for the male Depressed- Remitted (DP-RM) patients during the interview session.

Table 94: Optimization Results for the Male Patients DP-RM during the Interview Session

OPTIMIZATION TECHNIQUES	MALE DP- RM INTERVIEW		
	LINEAR	QUADRATIC	CROSS VALIDATED
Regular Results	83.00%	83.00%	82.30%
Increasing Number of Bands	84.20%	84.50%	82.30%
Increasing Band Range	58.50%	60.00%	55.50%
Increasing Band Number & Range	83.40%	82.60%	81.90%
Exponential Band Edges	77.70%	81.10%	77.40%
Exponential Band Edges & Increase Range	58.90%	61.10%	58.50%
Non-Uniform Band Edges	N/A	N/A	N/A
Non-Uniform Band Edges& Increase Range	N/A	N/A	N/A

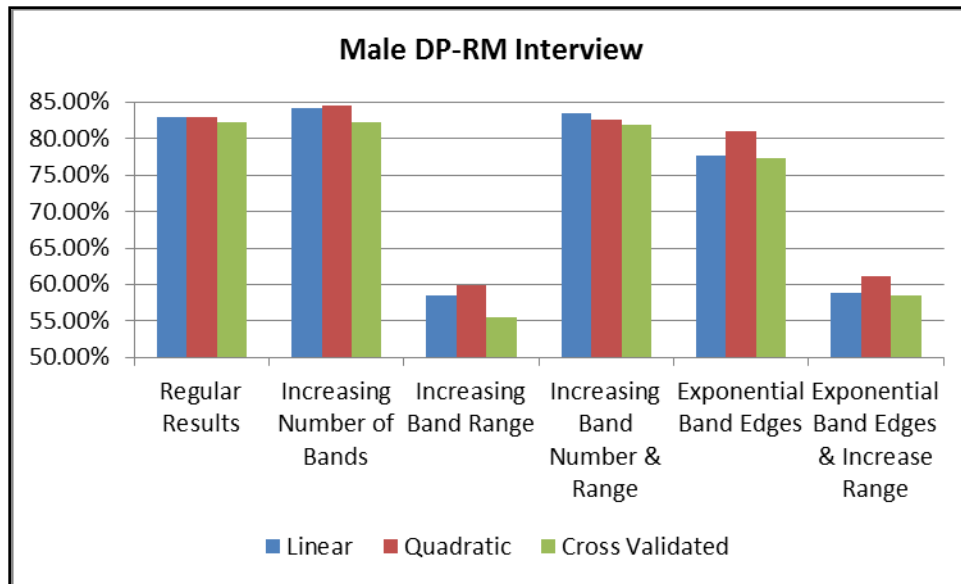

Figure 319: Male DP-RM Interview Session Result Comparison

The table below (Table 95), and the figure below (Figure 320) show the overall comparison of the optimization techniques for the male Depressed- Remitted (DP-RM) patients during the reading session.

Table 95: Optimization Results for the Male Patients DP-RM during the Reading Session

	MALE DP- RM READING		
OPTIMIZATION TECHNIQUES	LINEAR	QUADRATIC	CROSS VALIDATED
Regular Results	73.70%	75.80%	72.70%
Increasing Number of Bands	75.80%	75.80%	73.70%
Increasing Band Range	63.60%	65.70%	62.60%
Increasing Band Number & Range	76.80%	75.80%	73.70%
Exponential Band Edges	70.70%	74.70%	69.70%
Exponential Band Edges & Increase Range	68.70%	69.70%	68.70%
Non-Uniform Band Edges	N/A	N/A	N/A
Non-Uniform Band Edges& Increase Range	N/A	N/A	N/A

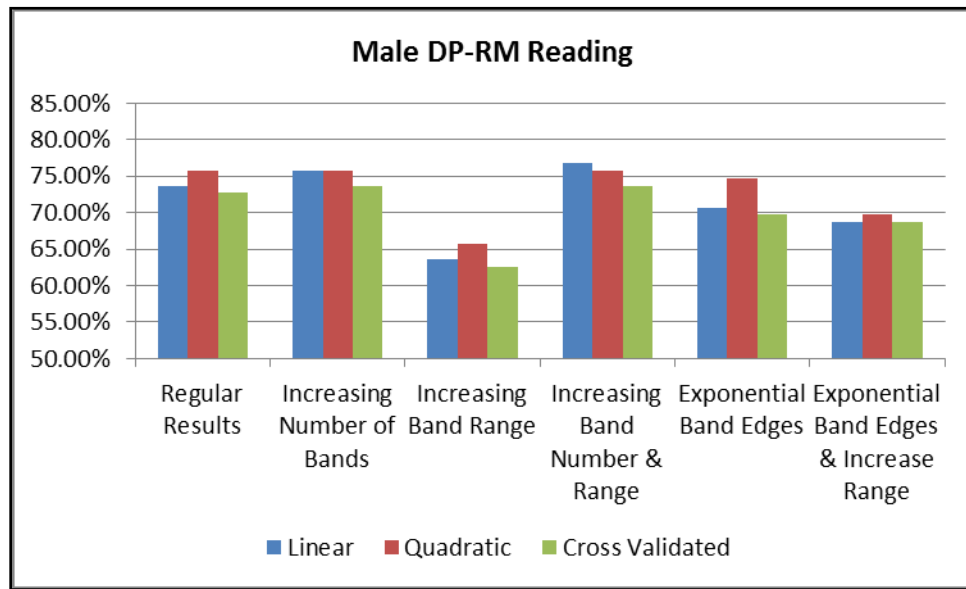

Figure 320: Male DP-RM Reading Session Result Comparison

The table below (Table 96), and the figure below (Figure 321) show the overall comparison of the optimization techniques for the male High Risk Suicidal – Remitted (HR-RM) patients during the interview session.

Table 96: Optimization Results for the Male Patients HR-RM during the Interview Session

	MALE HR -RM INTERVIEW		
OPTIMIZATION TECHNIQUES	LINEAR	QUADRATIC	CROSS VALIDATED
Regular Results	79.20%	79.20%	77.90%
Increasing Number of Bands	85.10%	85.10%	84.40%
Increasing Band Range	84.10%	83.80%	84.10%
Increasing Band Number & Range	89.00%	88.60%	87.70%
Exponential Band Edges	78.90%	77.90%	77.60%
Exponential Band Edges & Increase Range	82.80%	82.80%	82.50%
Non-Uniform Band Edges	N/A	N/A	N/A
Non-Uniform Band Edges& Increase Range	N/A	N/A	N/A

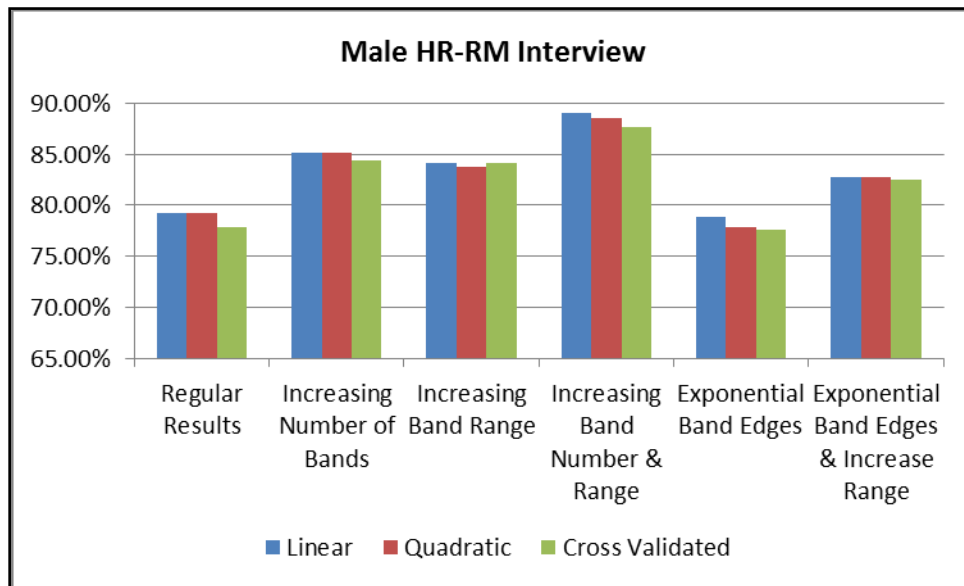

Figure 321: Male HR-RM Interview Session Result Comparison

The table below (Table 97), and the figure below (Figure 322) show the overall comparison of the optimization techniques for the male High Risk Suicidal – Remitted (HR-RM) patients during the reading session.

Table 97: Optimization Results for the Male Patients HR-RM during the Reading Session

	MALE HR- RM READING		
OPTIMIZATION TECHNIQUES	LINEAR	QUADRATIC	CROSS VALIDATED
Regular Results	72.30%	67.50%	72.30%
Increasing Number of Bands	81.90%	81.90%	78.30%
Increasing Band Range	80.70%	79.50%	79.50%
Increasing Band Number & Range	84.30%	84.30%	80.70%
Exponential Band Edges	72.30%	69.90%	69.90%
Exponential Band Edges & Increase Range	79.50%	75.90%	77.10%
Non-Uniform Band Edges	N/A	N/A	N/A
Non-Uniform Band Edges& Increase Range	N/A	N/A	N/A

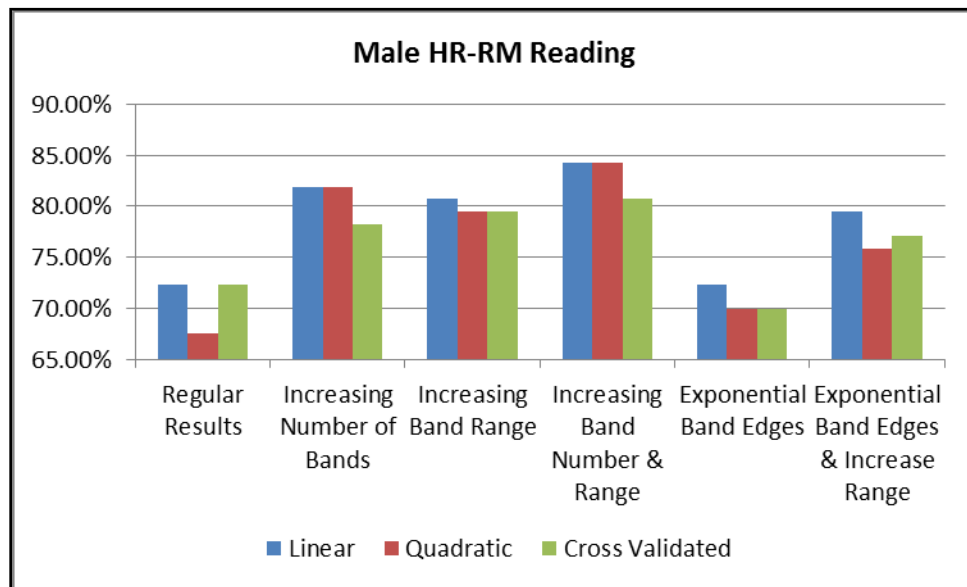

Figure 322: Male HR-RM Reading Session Result Comparison

In conclusion, for the male patients Table 98 shows all the overall optimization results using the linear classifier. Table 99 shows the overall optimization results using the quadratic classifier and Table 100 shows the overall optimization results with using the cross validated classifier.

Table 98: Optimization Results for the Male Patients Using the Linear Classifier

LINEAR CLASSIFIER	MALE PAIRWISE GROUPS					
	DP - HR Int	DP - HR Rnb	DP - RM Int	DP - RM Rnb	HR-RM Int	HR-RM Rnb
Increasing Number of Bands	✓	✓	✓	✓	✓	✓
Increasing Band Range	✓	✓	✗	✗	✓	✓
Increasing Band Number & Range	✓	✓	✗	✓	✓	✓
Exponential Band Edges	✗	✓	✗	✗	✗	✗
Exponential Band Edges & Increase Range	✓	✓	✗	✗	✓	✓
Non-Uniform Band Edges	✓	✓	N/A	N/A	N/A	N/A
Non-Uniform Band Edges& Increase Range	✓	✓	N/A	N/A	N/A	N/A

Table 99: Optimization Results for the Male Patients Using the Quadratic Classifier

QUADRATIC CLASSIFIER	MALE PAIRWISE GROUPS					
	DP - HR Int	DP - HR Rnb	DP - RM Int	DP - RM Rnb	HR-RM Int	HR-RM Rnb
Increasing Number of Bands	✓	✓	✓	✗	✓	✓
Increasing Band Range	✓	✓	✗	✗	✓	✓
Increasing Band Number & Range	✓	✓	✗	✗	✓	✓
Exponential Band Edges	✗	✓	✗	✗	✗	✓
Exponential Band Edges & Increase Range	✓	✓	✗	✗	✓	✓
Non-Uniform Band Edges	✓	✓	N/A	N/A	N/A	N/A
Non-Uniform Band Edges& Increase Range	✓	✓	N/A	N/A	N/A	N/A

Table 100: Optimization Results for the Male Patients Using the Cross Validated Classifier

CROSS VALIDATED CLASSIFIER	MALE PAIRWISE GROUPS					
	DP - HR Int	DP - HR Rnb	DP - RM Int	DP - RM Rnb	HR-RM Int	HR-RM Rnb
Increasing Number of Bands	✓	✓	✗	✗	✓	✓
Increasing Band Range	✓	✓	✗	✗	✓	✓
Increasing Band Number & Range	✓	✓	✗	✗	✓	✓
Exponential Band Edges	✗	✓	✗	✗	✗	✗
Exponential Band Edges & Increase Range	✓	✓	✗	✗	✓	✓
Non-Uniform Band Edges	✓	✓	N/A	N/A	N/A	N/A
Non-Uniform Band Edges& Increase Range	✓	✓	N/A	N/A	N/A	N/A

For male patients of the Depressed - High Risk Suicidal pairwise group during the interview session (DP-HR Int), all of the optimization techniques gave good results except for the exponential band edges. This conclusion was observed with all of the three classifier techniques. The classification rate is increased with the increasing the number of bands technique (3.55% → linear, 4.36% → quadratic, 3.44% → cross validated), with increasing the band range (8.73% → linear, 9.14% → quadratic, 9.22% → cross validated), with increasing the number of bands & range (10.91% → linear, 10.91% → quadratic, 11.42% → cross validated), with the exponential band edges & increased range (7.78% → linear, 8.32% → quadratic, 8.66% → cross validated), with the non-uniform band edges (7.84 → linear, 10.49% → quadratic) and with the non-uniform band edges & increased range (10.99% → linear, 10.87% → quadratic). During the reading session (DP-HR Rnb), all of the optimization techniques worked well and gave better classification rates after the optimization techniques. The classification rate is increased with the increasing the number of bands technique (21.60% → linear, 20.90% → quadratic, 19.04% → cross validated), with increasing the band range (20.00% → linear,

16.10% → quadratic, 22.52% → cross validated), with increasing the number of bands & range (23.36% → linear, 17.65% → quadratic, 22.52% → cross validated), with exponential band edges (18.40% → linear, 16.10% → quadratic, 19.04% → cross validated), with the exponential band edges & increased range (4.96% → linear, 3.25% → quadratic, 5.13% → cross validated), with the non-uniform band edges (29.71 → linear, 30.20% → quadratic) and with the non-uniform band edges & increase range (29.71% → linear, 30.20% → quadratic). As mentioned before, this DP-HR pairwise group is the most important and critical pairwise group in order to avoid deaths from the suicide attempts. If the high risk suicidal patients could be discriminated successfully from the depressed patients then the deaths from the suicides will be lowered.

For male patients of the Depressed - Remitted pairwise group during the interview session (DP-RM Int), only increasing the number of bands technique gave better classification rates with the linear and quadratic classifiers. With the cross validated classifiers, none of the optimization techniques worked well. The classification rate is increased with the increasing number of bands technique (1.45% → linear, 1.81% → quadratic). During the reading session (DP-RM Rnb), none of the optimization techniques worked well with the quadratic and cross validated classifiers. But with the linear classifier, increasing the number of bands and increasing the band numbers & range optimization techniques worked well and gave better classification rates. The classification rate is increased with the increasing number of bands technique (2.85% → linear), and with increasing the number of bands & range (4.21% → linear).

For the male patients of the High Risk Suicidal - Remitted pairwise group during the interview session (HR-RM Int), all of the available optimization techniques except

the exponential band edges gave good results with all three classifiers. The classification rate is increased with the increasing number of bands technique (7.45% → linear, 7.45% → quadratic, 8.34% → cross validated), with increasing the band range (6.19% → linear, 5.81% → quadratic, 7.96% → cross validated), with increasing the number of bands & range (12.37% → linear, 11.87% → quadratic, 12.58% → cross validated), and with exponential band edges & increased range (4.54% → linear, 4.54% → quadratic, 5.90% → cross validated). For the reading session (HR-RM Rnb), the same result was observed with the linear and cross validated classifiers. With the quadratic classifier, all of the available optimization techniques gave better classification results. The classification rate is increased with the increasing the number of bands technique (13.28% → linear, 21.33% → quadratic, 8.30% → cross validated), with increasing the band range (11.62% → linear, 17.78% → quadratic, 9.96% → cross validated), with the increasing number of bands & range (16.60% → linear, 24.89% → quadratic, 11.62% → cross validated), with exponential band edges (3.56% → quadratic), and with exponential band edges & increased range (9.96% → linear, 12.44% → quadratic, 6.64% → cross validated).

CHAPTER V

GENDER SPECIFIC DIFFERENCES ON OPTIMIZED ENERGY BANDS

Abstract

People usually have no difficulties in identification of a speaker's gender since the male speech and the female speech are obviously different. Generally, the female speakers have higher fundamental frequency [169] and higher formant frequencies [170]. The male speakers typically have a low fundamental frequency as a result of having a larger body size [171]. On the other hand, the female speakers have a smaller body [171]. There are many factors that may lead to differences between the female and male voices [172]. The aim of this research is finding gender specific differences on optimized energy bands.

According to the results, there are statistically significant gender differences in different optimized energy bands for the Depressed (DP) and the High Risk Suicidal (HR) pairwise group during the interview session. There are 14 statistically significant features, which are PSD 3 (4 bands in the 0-2000 Hz), PSD 4 (5 bands in the 0-2000 Hz), PSD 4 (6 bands in the 0-2000 Hz), PSD 5 (7 bands in the 0-2000 Hz), PSD 5 (8 bands in the 0-2000 Hz), PSD 6 (8 bands in the 0-2000 Hz), PSD 6 (9 bands in the 0-2000 Hz), PSD 2 (10 bands in the 0-2000 Hz), PSD 7 (10 bands in the 0-2000 Hz), PSD 3 (6 bands in the 0-3000 Hz), PSD 4 (8 bands in the 0-3000 Hz), PSD 4 (9 bands in the 0-3000 Hz), PSD 5 (10 bands in the 0-3000 Hz), and PSD 2 (Non-Uniform Edged Bands in the 0-2000 Hz) where PSD X (Y bands in 0-F Hz) denotes band of X of Y bands in the 0-F Hz

frequency range. In all of them, the female patients' mean value decreases and the male patient's mean value increases significantly when moving from HR to DP. We see, they are moving opposite to each other. During the reading session of the DP-HR pairwise group, there are 4 statistically significant features which are PSD 2 (8 bands in the 0-2000 Hz), PSD 2 (9 bands in the 0-2000 Hz), PSD 2 (10 bands in the 0-2000 Hz), and PSD 2 (Exponential bands in the 0-2000 Hz). In all of them, the female patients' mean value decreases and the male patient's mean value increases significantly when moving from the HR to the DP. In both of interview and the reading sessions, the female patients' mean value decreases and the male patient's mean value increases significantly when moving from the high risk suicidal (HR) state to the depressed (DP) state.

There are no statistically significant gender differences in different optimized energy bands for the High Risk Suicidal-Remitted (HR-RM) pairwise group during the interview session and during the reading session.

There exist statistically significant gender differences in different optimized energy bands for the Depressed (DP) and the Remitted (RM) pairwise group during the interview session. There are 26 statistically significant features which are PSD 2 (2 bands in the 0-2000 Hz), PSD 3 (4 bands in the 0-2000 Hz), PSD 4 (5 bands in the 0-2000 Hz), PSD 4 (6 bands in the 0-2000 Hz), PSD 5 (6 bands in the 0-2000 Hz), PSD 5 (7 bands in the 0-2000 Hz), PSD 6 (7 bands in the 0-2000 Hz), PSD 5 (8 bands in the 0-2000 Hz), PSD 6 (8 bands in the 0-2000 Hz), PSD 5 (9 bands in the 0-2000 Hz), PSD 6 (9 bands in the 0-2000 Hz), PSD 7 (9 bands in the 0-2000 Hz), PSD 6 (10 bands in the 0-2000 Hz), PSD 7 (10 bands in the 0-2000 Hz), PSD 8 (10 bands in the 0-2000 Hz), PSD 2 (3 bands in the 0-3000 Hz), PSD 3 (5 bands in the 0-3000 Hz), PSD 3 (6 bands in the 0-3000 Hz)

, PSD 3 (7 bands in the 0-3000 Hz) , PSD 4 (7 bands in the 0-3000 Hz) , PSD 4 (8 bands in the 0-3000 Hz) , PSD 4 (9 bands in the 0-3000 Hz) , PSD 5 (9 bands in the 0-3000 Hz) , PSD 4 (10 bands in the 0-3000 Hz) , PSD 5 (10 bands in the 0-3000 Hz) , and PSD 4 (Exponential bands in the 0-2000 Hz). In all of them, the female patients' mean value increases and the male patient's mean value decreases significantly when moving from the DP to the RM. During the reading session of DP-RM pairwise group, there are 2 statistically significant features which are PSD 5 (8 bands in the 0-2000 Hz), and PSD 4 (9 bands in the 0-3000 Hz). In all of them, the female patients' mean value increases and the male patient's mean value decreases significantly when moving from the DP to the RM. In both the interview and the reading sessions, the female patients' mean value increases and the male patient's mean value decreases significantly when moving from depressed (DP) state to the remitted (RM) state. So, they are moving opposite to each other.

Spontaneous speech (interview session) is more effective for revealing gender differences than the controlled reading speech (reading session). There are 14 statistically significant features that are different for different genders for the DP-HR pairwise group during the interview session and there are 26 statistically significant features that are different for different genders for the DP-RM pairwise group during the interview session. In total, this makes 40 statistically significant features that are different for different genders during the interview sessions. On the other hand, there are only 4 statistically significant features for the DP-HR pairwise group during the reading session and only 2 statistically significant features that are different for different genders for the

DP-RM pairwise group during the reading session. This makes 6 statistically significant features that are different for different genders during the reading sessions.

1 Introduction

In this research, the gender differences in distinguishing high-risk suicidal patients from depressed patients and remitted patients will be studied. It seems that in some cases there exist specific different results for female patients and male patients [172]. In this research, whether there really are specific differences between genders will be examined on optimized energy bands. There are many factors that may lead to differences between female and male voices. In general, there are three types of parameters that are related to the differences between the genders. Two that can be measured objectively are physiological parameters and acoustical parameters. The third type is perceptual parameters. These parameters are subjective and are evaluated psychophysically. [172]

Many physiological parameters were measured and compared for distinguishing female and male voices. Vocal tract length [173, 174], larynx [175, 176], nasalance scores (ratio of nasal to nasal – plus – oral acoustic energy) [177, 178] are some of the physiological parameters that are different for genders. [172]

Gender differences in acoustical characteristics of speech are in part the result of differences in physical attributes. Vocal tract size, vocal tract shape, and vocal fold length are some of the anatomical dimensions that affect the acoustical structure of an individual's speech. In the literature, the acoustic differences between male and female speech have been observed using a variety of features and analyses [172]. Formant

frequencies [179, 180], fundamental frequency (pitch) [180, 181, 182, 183, 184, 185, 186, 187, 188, 189], formant frequencies [190, 191, 192], aspiration noise [193, 194], jitter [195, 196], shimmer [197, 198], and speaking rate [199, 200, 201] are some of these acoustic features.

There exists a strong connection between a speaker's physical attributes and the acoustic realization of their speech. But gender-specific variations cannot be entirely explained by anatomical differences between the male speakers and female speakers. Sachs et al. [202] investigated that the stylistic or the behavioral factors affects some part of the sex-linked acoustic variability of the adults. Moreover, Byrd [203], Swartz [204], and Whiteside [205] observed that female speakers have longer utterance durations, slower articulation rates and less phonetic reduction than male speakers. Singh et al. [206] and Murry et al. [207] suggested that different perceptual strategies may be used to classify male voices and female voices. Effort, pitch, and nasality are the ones used to judge female voices, while effort, pitch, and hoarseness are the ones used for male voices. Many researchers believe that melodic cues such as intonation, stress, and coarticulation are characteristics associated with female voices [206, 207]. Besides, according to Klatt [208] and Klatt et al. [194] the female voice is typically more breathy than the male voice. Hanson [209] and Sulter et al. [210] reported that the female voices are perceived as more breathy than the male voices because of the gender differences in the glottal configurations.

In this research, the gender specific differences on optimized energy bands will be analyzed. This paper presents the methodology of this research in Chapter V.2; Chapter V.3 will give detailed information about the experimental results of the gender

comparison on optimized energy bands; Chapter V.4 will present the performance evaluation for the gender specific differences on optimized energy bands; and finally Chapter V.5 will present the discussion and conclusion.

2 Methodology

2.1 Database

Two different types of audio recordings from depressed patients (diagnosed with depression), high risk suicidal patients (diagnosed with high risk suicide), and remitted patients (diagnosed with remission from the depression) were gathered and analyzed. One type is audio recordings that were gathered from clinical interviews which were completed with a therapist. This type of recording will be named the “*Interview Session*”, and is spontaneous speech. The other one was gathered while the patients were reading a predetermined passage named the “*Rainbow Passage*” [16], and they will be named the “*Reading Session*”. This passage is a very popular in the speech science. It is phonetically balanced and it contains all of the normal sounds in the spoken English. The *depressed patients* were evaluated during the clinical interview by psychiatrists using the Hamilton depression rating scale [162]. With this scale, the psychiatrists also evaluated if the patient is at risk of committing suicide, and this group of people are named as *high risk suicidal patients*. The last group of patients is named *remitted patients* who recovered from depression after treatment. Table 101 and Table 102 below show the number of patients in the database for each group of patients for the female and male patients. The ages of the subjects were between 25 and 65 years.

Table 101: The Number of the Female Patients in the Database

FEMALE PATIENTS		
	INTERVIEW	READING
Depressed	18	16
High Risk Suicidal	11	9
Remitted	14	14

Table 102: The Number of the Male Patients in the Database

MALE PATIENTS		
	INTERVIEW	READING
Depressed	13	14
High Risk Suicidal	10	9
Remitted	9	11

All speech samples were digitized with a 16-bit analog to digital converter with a sampling rate of 10 kHz and with a 5 kHz low pass filter (an anti-aliasing filter). The background noises and the voices different from the patient's voice were removed using the audio editor software, Gold Wave. With the help of this software, the silent periods which were longer than 0.5 seconds were removed. In this research, a portable audio acquisition system was used. This system has a Sony VAIO laptop which has Pentium IV 2 GHz CPU, 512 Mb memory, 60 GB hard drive, 20X CD/DVD read/write unit, 250 GB external hard drive, Windows XP OS, and it has ProTools LE digital audio editor; Digital Audio Mbox for the audio signal acquisition; and Audix SCX-one cardioid microphone.

The segments were edited to minimize the introduction of spurious frequency effects resulting from the abrupt transitions in the edited speech by selecting the segmentation points at the zero crossings or at the beginning of the pauses in the edited continuous speech. Afterwards, these edited segments were tested for voicing and only

the voiced segments were kept for analyses. Then, the voiced speech was detrended and normalized to have a variance of one for compensating the possible recording level differences. Afterwards, the voiced speech samples were divided into 20 second segments and used with spectrum analysis to determine the power spectral density estimates.

2.2 Feature Extraction

In this research, energy in the frequency bands is used as a feature. Power Spectral Density (PSD) estimates were calculated for each 20 – second voice speech segment using the Welch method with a 400 – point Hamming window and consecutive windows which were non – overlapping. 1024 – point fast Fourier transforms (FFT) were used to implement the PSD estimation algorithm in MATLAB. For the PSD estimates, individual 40 – msec frames of voiced speech were analyzed [126, 150]. The Welch PSD estimation method for extracting the spectral energy band features for four equal energy bands in the frequency range of 0 – 2000 Hz is outlined below in Figure 323:

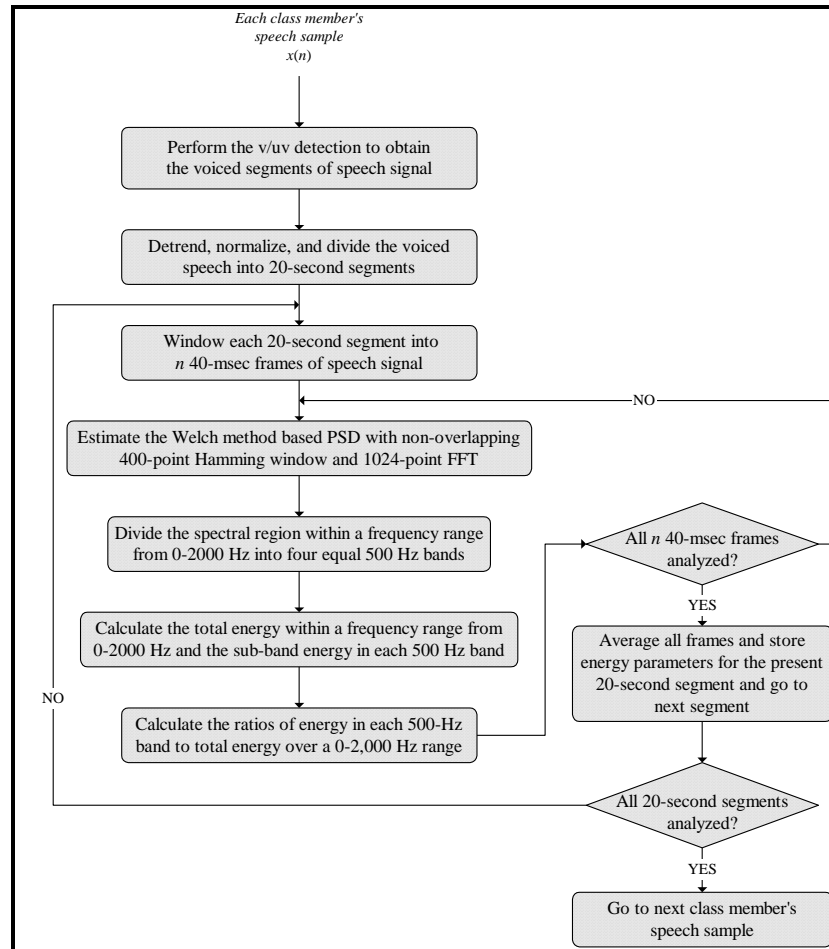

Figure 323: Spectral Energy Feature Extraction Algorithm Flowchart (for 4 equal bands in the 0-2000 Hz band range)

In this research, different methods were used and different numbers of features were extracted to find optimized energy bands for classifying the high risk suicidal from the depressed and remitted patients. Different numbers of energy bands (2, 3, 4, 5, 6, 7, 8, 9, 10 bands), different energy band ranges (0-2000 Hz, 0-3000 Hz); different energy band edges (exponential and non-uniform edges) were analyzed for finding the optimized energy bands. The following tables show the features (Table 103a) and associated

frequency ranges (Table 103b) that were used in this research. Detailed information about the optimized energy bands was given in Chapter IV.

Table 103a: The Features Used in Optimized Energy Bands Study

ANALYSIS TYPE	FEATURES
2 Equal bands in 0 - 2000 Hz	PSD 1, PSD 2
3 Equal bands in 0 - 2000 Hz	PSD 1, PSD 2, PSD 3
4 Equal bands in 0 - 2000 Hz	PSD 1, PSD 2, PSD 3, PSD 4
5 Equal bands in 0 - 2000 Hz	PSD 1, PSD 2, PSD 3, PSD 4, PSD 5
6 Equal bands in 0 - 2000 Hz	PSD 1, PSD 2, PSD 3, PSD 4, PSD 5, PSD 6
7 Equal bands in 0 - 2000 Hz	PSD 1, PSD 2, PSD 3, PSD 4, PSD 5, PSD 6, PSD 7
8 Equal bands in 0 - 2000 Hz	PSD 1, PSD 2, PSD 3, PSD 4, PSD 5, PSD 6, PSD 7, PSD 8
9 Equal bands in 0 - 2000 Hz	PSD 1, PSD 2, PSD 3, PSD 4, PSD 5, PSD 6, PSD 7, PSD 8, PSD 9
10 Equal bands in 0 - 2000 Hz	PSD 1, PSD 2, PSD 3, PSD 4, PSD 5, PSD 6, PSD 7, PSD 8, PSD 9, PSD 10
0 - 3000 Hz	
2 Equal bands in 0 - 3000 Hz	PSD 1, PSD 2
3 Equal bands in 0 - 3000 Hz	PSD 1, PSD 2, PSD 3
4 Equal bands in 0 - 3000 Hz	PSD 1, PSD 2, PSD 3, PSD 4
5 Equal bands in 0 - 3000 Hz	PSD 1, PSD 2, PSD 3, PSD 4, PSD 5
6 Equal bands in 0 - 3000 Hz	PSD 1, PSD 2, PSD 3, PSD 4, PSD 5, PSD 6
7 Equal bands in 0 - 3000 Hz	PSD 1, PSD 2, PSD 3, PSD 4, PSD 5, PSD 6, PSD 7
8 Equal bands in 0 - 3000 Hz	PSD 1, PSD 2, PSD 3, PSD 4, PSD 5, PSD 6, PSD 7, PSD 8
9 Equal bands in 0 - 3000 Hz	PSD 1, PSD 2, PSD 3, PSD 4, PSD 5, PSD 6, PSD 7, PSD 8, PSD 9
10 Equal bands in 0 - 3000 Hz	PSD 1, PSD 2, PSD 3, PSD 4, PSD 5, PSD 6, PSD 7, PSD 8, PSD 9, PSD 10
Exponential bands	
4 Exponential bands in 0 - 2000 Hz	PSD 1, PSD 2, PSD 3, PSD 4
4 Exponential bands in 0 - 3000 Hz	PSD 1, PSD 2, PSD 3, PSD 4
Non-Uniform bands	
4 Non-Uniform bands in 0 - 2000 Hz	PSD 1, PSD 2, PSD 3, PSD 4
4 Non-Uniform bands in 0 - 3000 Hz	PSD 1, PSD 2, PSD 3, PSD 4

Table 103b: The Frequency Ranges Used in Optimized Energy Bands Study

ANALYSIS TYPE	FREQUENCY RANGES (in Hz)
2 Equal bands in 0 - 2000 Hz	0 - 1000, 1000 - 2000
3 Equal bands in 0 - 2000 Hz	0 - 666, 666 - 1333, 1333 - 2000
4 Equal bands in 0 - 2000 Hz	0- 500, 500 - 1000, 1000 - 1500, 1500 - 2000
5 Equal bands in 0 - 2000 Hz	0- 400, 400 - 800, 800 - 1200, 1200 - 1600, 1600 - 2000
6 Equal bands in 0 - 2000 Hz	0-333, 333-666, 666-1000, 1000-1333, 1333- 1666, 1666-2000
7 Equal bands in 0 - 2000 Hz	0 -285, 285-571, 571-857, 857-1143, 1143-1429, 1429-1715,1715-2000
8 Equal bands in 0 - 2000 Hz	0-250,250-500, 500-750, 750-1000, 1000-1250, 1250-1500, 1500-1750, 1750-2000
9 Equal bands in 0 - 2000 Hz	0-222, 222-445, 445- 667,667-889, 889-1111, 1111-1333, 1333-1555, 1555-1777, 1777- 2000
10 Equal bands in 0 - 2000 Hz	0-200,200-400,400-600,600-800,800-1000,1000-1200,1200-1400,1400-1600,1600-1800,1800-2000
0 - 3000 Hz	
2 Equal bands in 0 - 3000 Hz	0-1500, 1500- 3000
3 Equal bands in 0 - 3000 Hz	0-1000, 1000-2000, 2000-3000
4 Equal bands in 0 - 3000 Hz	0-750, 750-1500, 1500-2250, 2250-3000
5 Equal bands in 0 - 3000 Hz	0-600, 600-1200, 1200-1800, 1800-2400, 2400-3000
6 Equal bands in 0 - 3000 Hz	0-500, 500-1000, 1000-1500, 1500-2000, 2000-2500, 2500-3000
7 Equal bands in 0 - 3000 Hz	0-428, 428-857, 857-1286, 1286-1714,1714-2142,2142- 2571, 2571- 3000
8 Equal bands in 0 - 3000 Hz	0-375, 375-750, 750-1125,1125-1500,1500-1875, 1875-2250,2250-2625,2625- 3000
9 Equal bands in 0 - 3000 Hz	0-333, 333-667,667 -1000, 1000-1333, 1333-1666, 1666-1999, 1999-2332, 2332-2666, 2666-3000
10 Equal bands in 0 - 3000 Hz	0-300,300-600,600-900, 900-1200, 1200-1500, 1500-1800, 1800-2100, 2100-2400,2400-2700, 2700-3000
0 - 2000 Hz	
4 Exponential bands in 0 - 2000 Hz	0 - 250 Hz, 250 - 500 Hz, 500 - 1000 Hz, 1000 - 2000 Hz
0 - 3000 Hz	
4 Exponential bands in 0 - 3000 Hz	0 - 375 Hz, 375 - 750 Hz, 750 - 1500 Hz, 1500 - 3000 Hz
0 - 2000 Hz	
4 Non-Uniform bands in 0 - 2000 Hz	Check Table 44 in Chapter 4
0 - 3000 Hz	
4 Non-Uniform bands in 0 - 3000 Hz	Check Table 49 in Chapter 4

3 Experimental Results of Gender Comparison on Optimized Energy Bands

The gender differences are analyzed on optimized energy bands. Different numbers of energy bands (2, 3, 4, 5, 6, 7, 8, 9, 10 bands), different energy band ranges (0-2000 Hz, 0-3000 Hz); different energy band edges (exponential and non-uniform edges) were analyzed for finding the optimized energy bands. This chapter will explain the experimental results of the gender differences on these optimized energy bands. Initially, the classification rates of different band numbers in the 0-2000 Hz frequency range and in the 0-3000 Hz frequency range will be compared for both genders in Chapter 5.3.1. Then, statistically significant energy band features which are different for female and male patients will be analyzed and reported in Chapter 5.3.2.

3.1 Comparison of Gender for Different Band Ranges & Different Band Numbers

Different numbers of energy bands have been studied and their effects on the classification have been analyzed for both genders. Different numbers of energy bands were analyzed in the 0 – 2000 Hz frequency range. Two equal bands (0-1000 Hz, 1000-2000 Hz), three equal bands (0-666 Hz, 666-1333 Hz, 1333-2000 Hz), five equal bands (0-400 Hz, 400-800 Hz, 800-1200 Hz, 1200- 1600 Hz, 1600- 2000 Hz), six equal bands (0-333 Hz, 333-666 Hz, 666-1000 Hz, 1000-1333 Hz, 1333-1666 Hz, 1666-2000 Hz), seven equal bands (0-285 Hz, 285-571 Hz, 571-857 Hz, 857-1143 Hz, 1143-1429 Hz, 1429-1715 Hz, 1715-2000 Hz), eight equal bands (0-250 Hz, 250-500 Hz, 500-750 Hz, 750-1000 Hz, 1000-1250 Hz, 1250- 1500 Hz, 1500-1750 Hz, 1750-2000 Hz), nine equal bands (0-222 Hz, 222-445 Hz, 445- 667 Hz, 667-889 Hz, 889-1111 Hz, 1111-1333 Hz, 1333-1555 Hz, 1555-1777 Hz, 1777-2000 Hz) and ten equal bands (0-200 Hz, 200-400 Hz, 400-600 Hz, 600-800 Hz, 800-1000 Hz, 1000-1200 Hz, 1200-1400 Hz, 1400-1600 Hz, 1600- 1800 Hz, 1800-2000 Hz) were examined for both female patients and male patients. Three different pairwise groups were investigated which are the Depressed – High Risk Suicidal (DP-HR) pairwise group, the Depressed – Remitted (DP-RM) pairwise group, and the High Risk Suicidal – Remitted (HR-RM) pairwise group. Two different types of recordings (the interview session and the reading session) were analyzed for both of the female and the male patients.

DP – HR Pairwise Group Comparison:

The classification rates for the both genders are analyzed below for the DP-HR (Depressed-High Risk Suicidal) pairwise group during the interview session for the 0-2000 Hz frequency range and the 0-3000 Hz frequency range. Figure 324 shows the results of the linear classifier, Figure 325 shows the results of the cross validated classifier; Figure 326 shows the results of quadratic classifier. According to all classifiers; when the number of bands is increased, the male patients gave a stable classification rates for both the 0-2000 Hz and the 0-3000 Hz frequency ranges. The classification rates get better when the 0-3000 Hz frequency range is used for the male patients but the classification rates are better with the 0-2000 Hz frequency range for the female patients. In general, the male patients' classification rates are better than the female patients' classification rates.

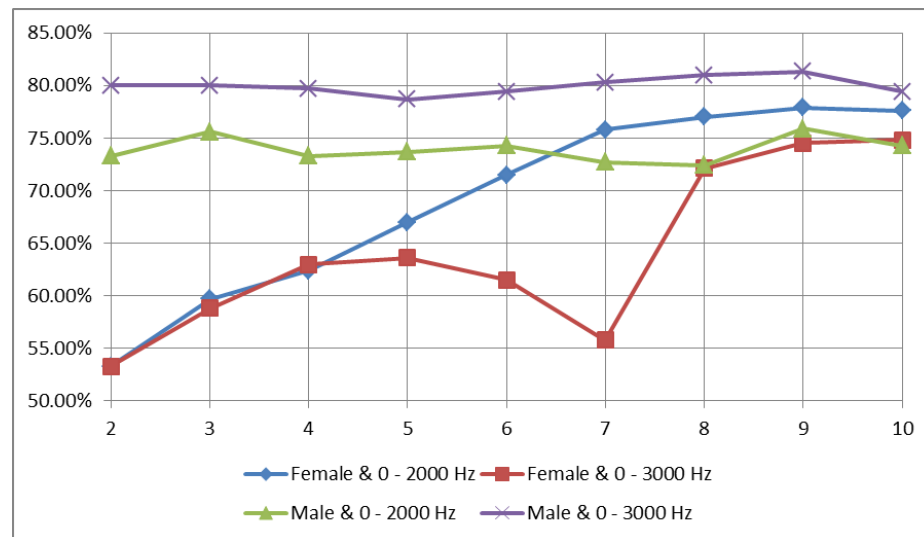

Figure 324: Comparison of the Gender for the DP – HR Pair Interview with the Linear Classification

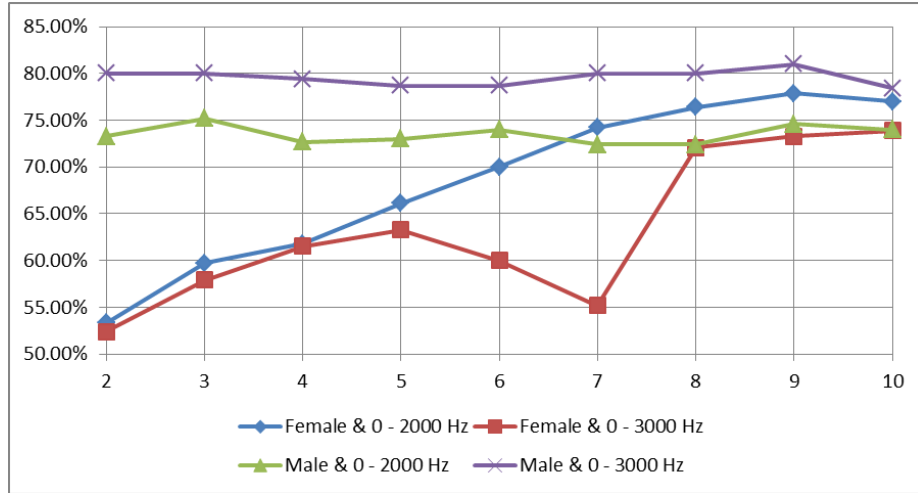

Figure 325: Comparison of the Gender for the DP – HR Pair Interview with the Cross Validated Classification

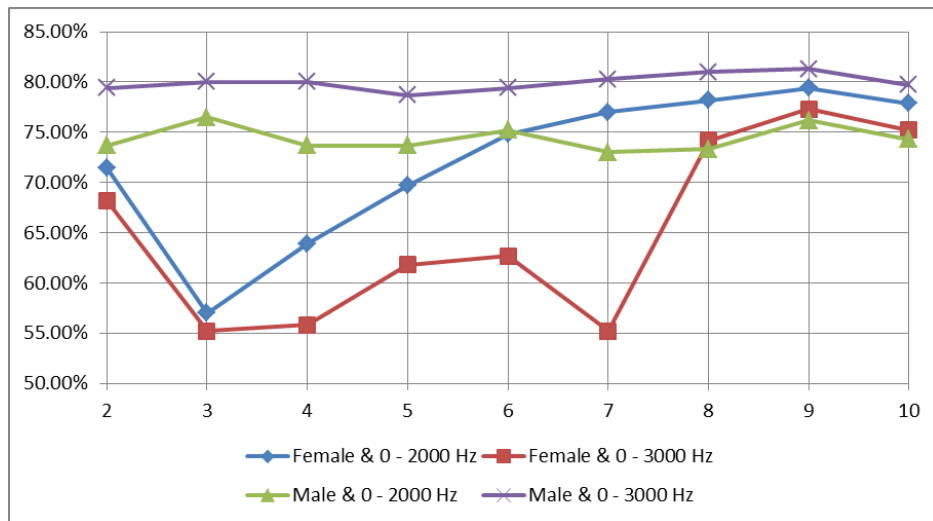

Figure 326: Comparison of the Gender for the DP – HR Pair Interview with the Quadratic Classification

Figure 327 shows the results of the linear classifier for the DP-HR (Depressed-High Risk Suicidal) pairwise group during the reading session; Figure 328 shows the results of the cross validated classifier for the DP-HR (Depressed-High Risk Suicidal) pairwise group during the reading session; Figure 329 shows the results of the quadratic classifier for the DP-HR (Depressed-High Risk Suicidal) pairwise group during the reading session. It can be observed from the graph that the classification rates for 2, 3 and 4 bands are consistently high for the male patients in the 0 – 3000Hz frequency range.

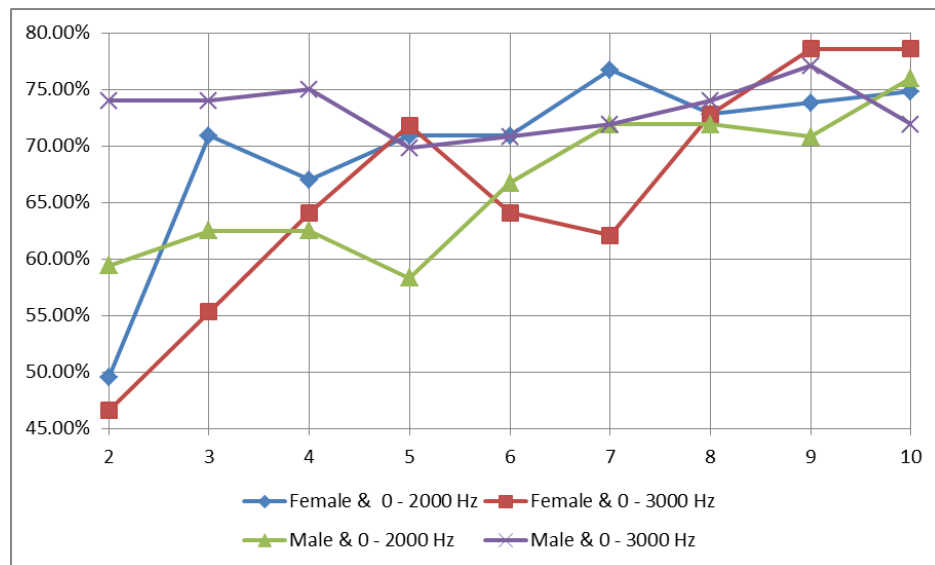

Figure 327: Comparison of the Gender for the DP – HR Pair Reading with the Linear Classification

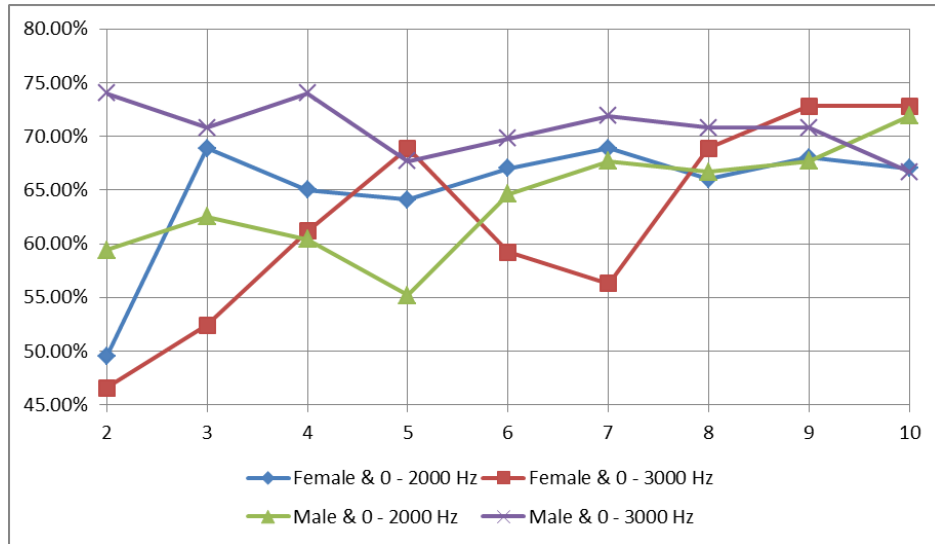

Figure 328: Comparison of the Gender for the DP – HR Pair Reading with the Cross Validated Classification

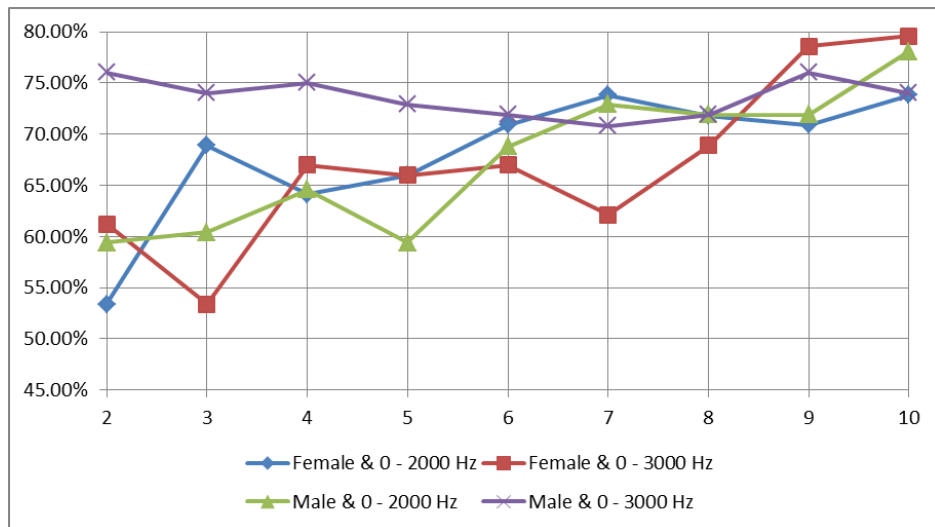

Figure 329: Comparison of the Gender for the DP – HR Pair Reading with the Quadratic Classification

3.2 DP – RM Pairwise Group Comparison

The classification rates for both genders are analyzed below for the DP-RM (Depressed-Remitted) pairwise group during the interview session for the 0-2000 Hz frequency range and the 0-3000 Hz frequency range. Figure 330 shows the results of the linear classifier, Figure 331 shows the results of the cross validated classifier; Figure 332 shows the results of the quadratic classifier. According to all classifiers, the classification rates are better with the 0-2000 Hz frequency range for the male patients except for 3 bands. The male patients' classification rates are better than the female patients' classification rates for the band numbers that are larger than 4 bands.

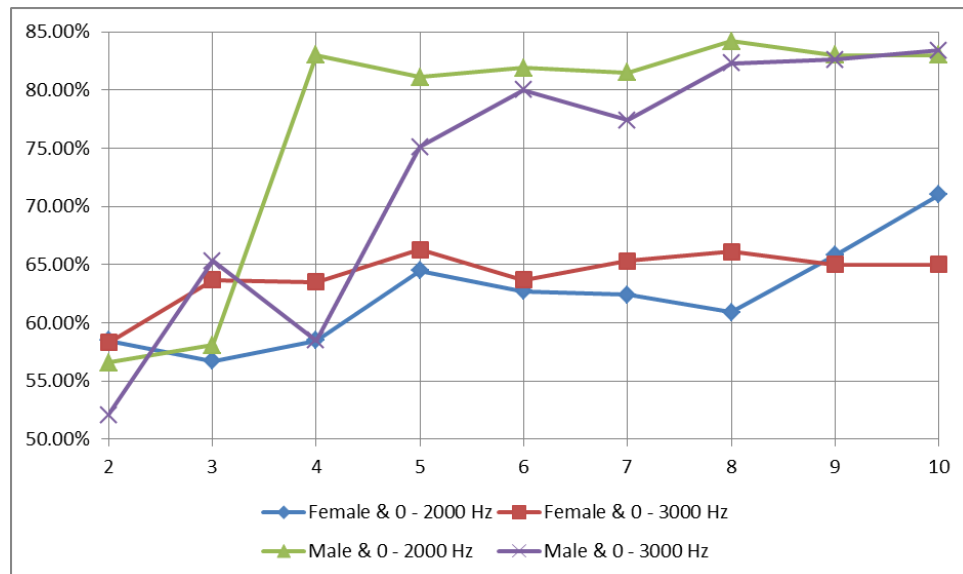

Figure 330: Comparison of the Gender for the DP – RM Pair Interview with the Linear Classification

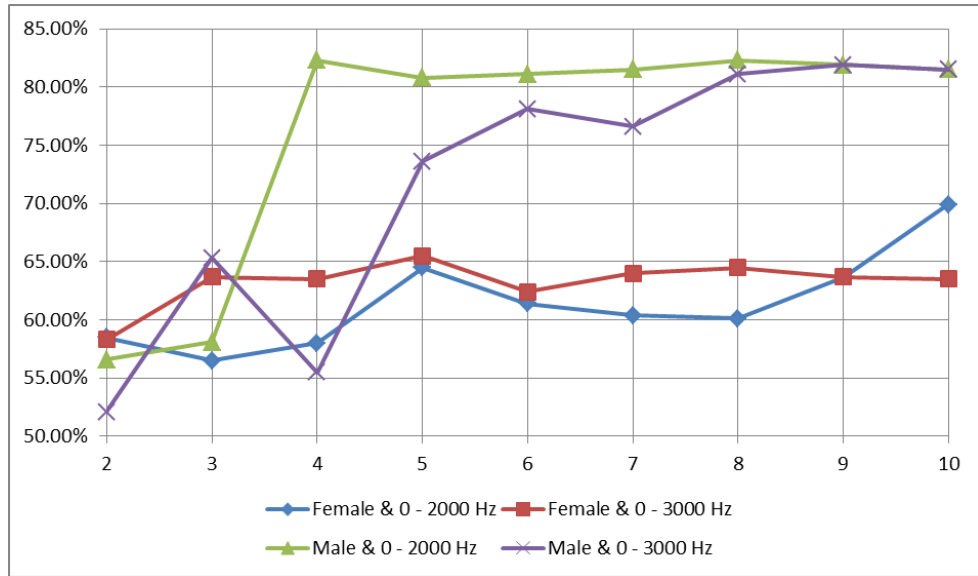

Figure 331: Comparison of the Gender for the DP – RM Pair Interview with the Cross Validated Classification

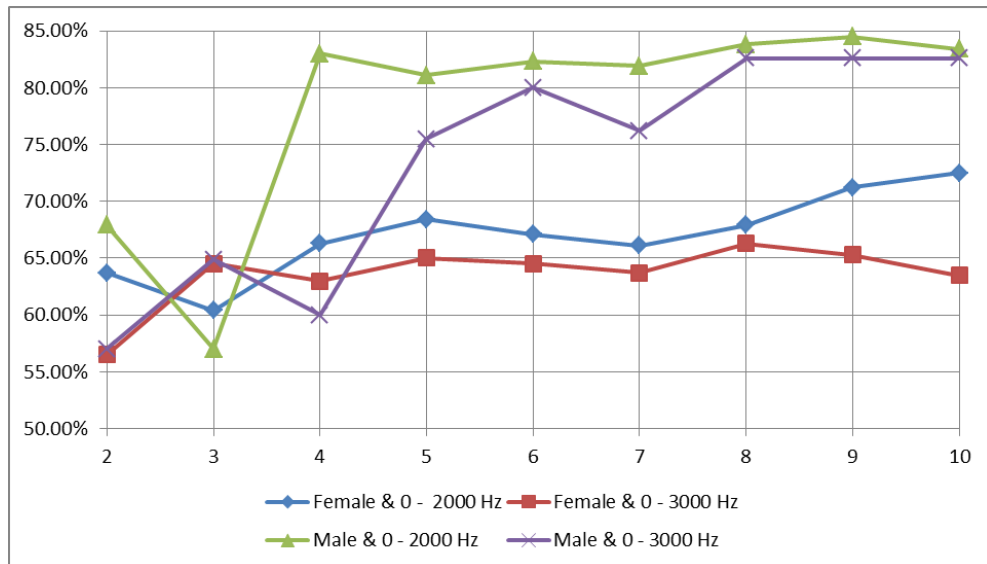

Figure 332: Comparison of the Gender for the DP – RM Pair Interview with the Quadratic Classification

Figure 333 shows the results of the linear classifier for the DP-RM (Depressed-Remitted) pairwise group during the reading session; Figure 334 shows the results of the cross validated classifier for the DP-RM(Depressed- Remitted) pairwise group during the reading session; Figure 335 shows the results of the quadratic classifier for the DP-RM (Depressed- Remitted) pairwise group during the reading session. No clear conclusions can be obtained from these graphs.

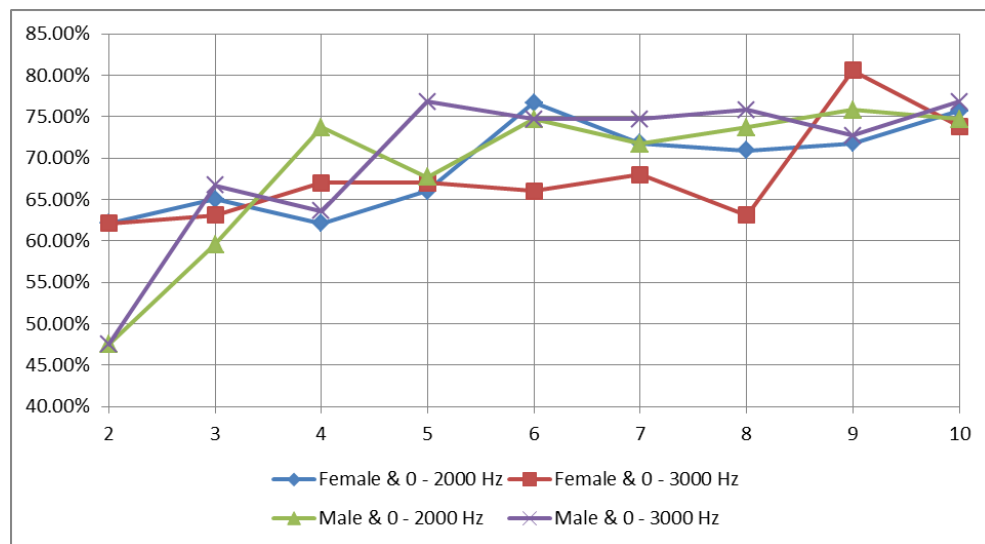

Figure 333: Comparison of the Gender for the DP – RM Pair Reading with the Linear Classification

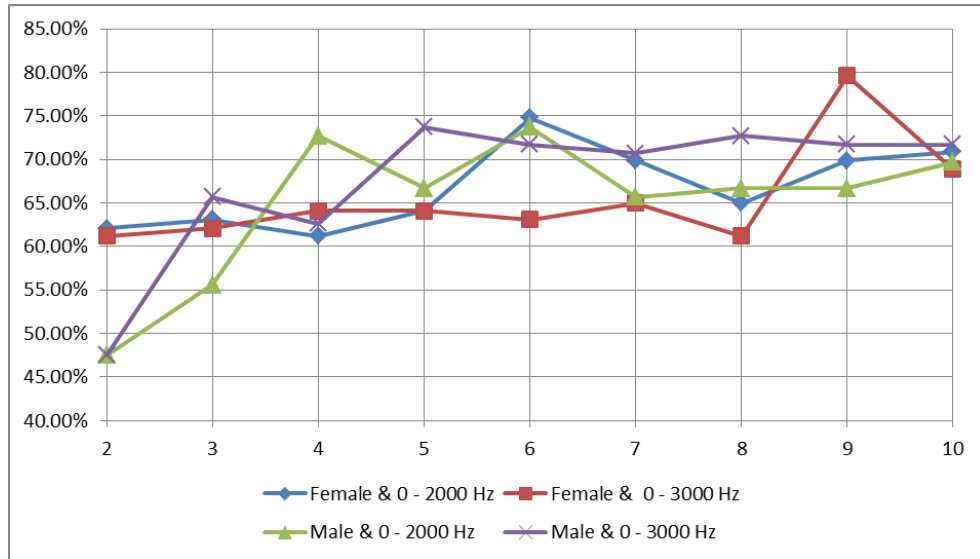

Figure 334: Comparison of the Gender for the DP – RM Pair Reading with the Cross Validated Classification

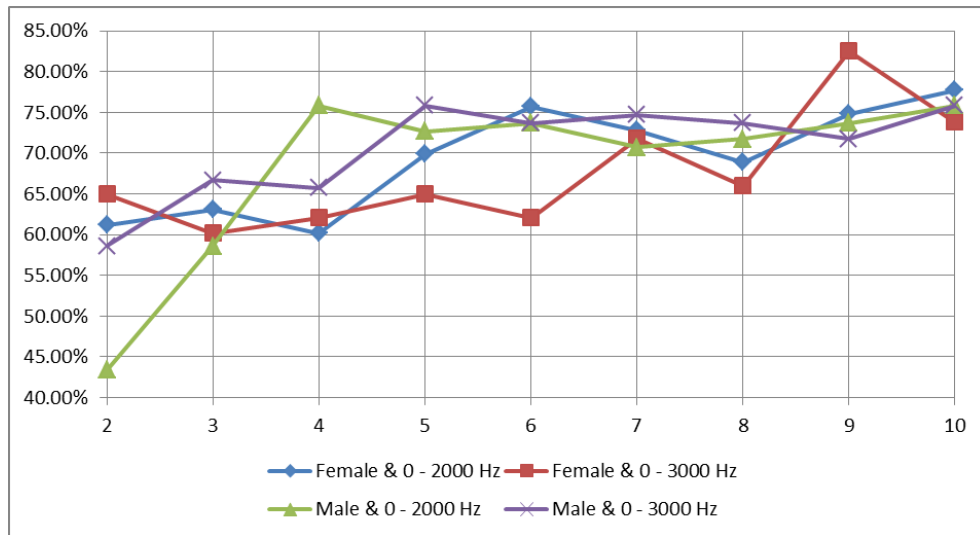

Figure 335: Comparison of the Gender for the DP – RM Pair Reading with the Quadratic Classification

3.3 HR – RM Pairwise Group Comparison

The High Risk Suicidal-Remitted (HR-RM) pairwise group during the interview session for the 0-2000 Hz frequency range and the 0-3000 Hz frequency range are analyzed with three different classifiers. Figure 336 shows the results of the classification rates for the linear classifier; Figure 337 shows the results of the classification rates for the cross validated classifier, and Figure 338 shows the results of the classification rates for the quadratic classifier.

According to all classifiers, the classification rates get better when the frequency range is increased to the 0-3000 Hz for the male patients except for 9 bands and 10 bands. According to all classifiers; when the number of bands is increased for both the 0-2000 Hz and the 0-3000 Hz frequency ranges, the male patients gave more stable classification rates than the female patients. In general, the male patients' classification rates are better than the female patients' classification rates.

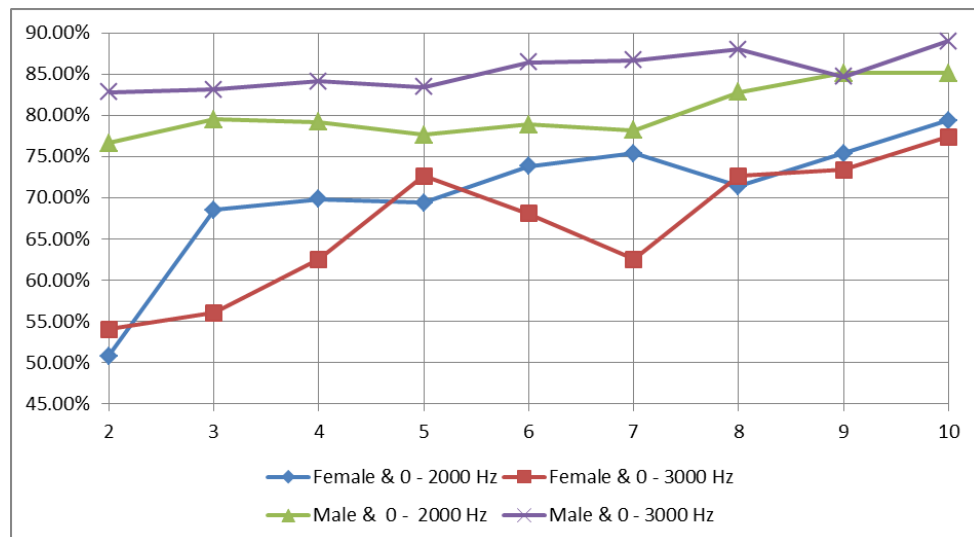

Figure 336: Comparison of the Gender for the HR – RM Pair Interview with the Linear Classification

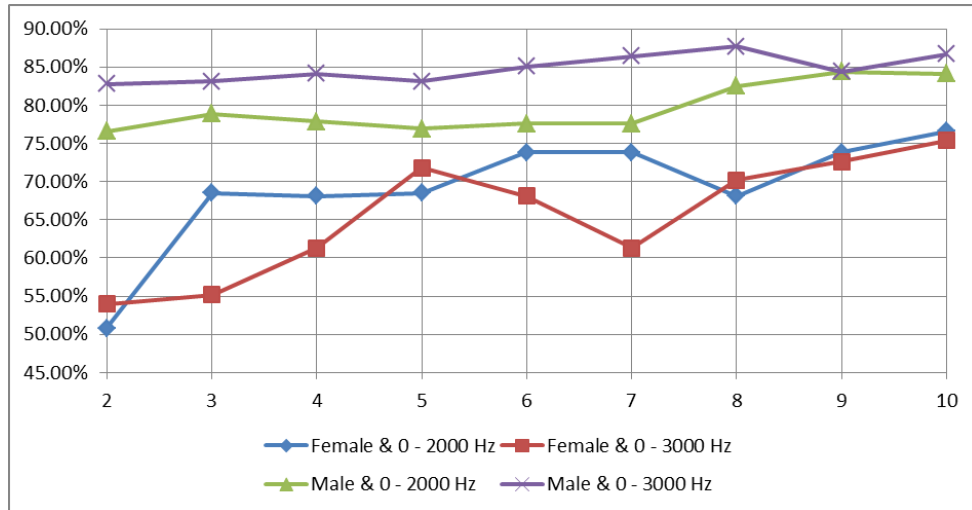

Figure 337: Comparison of the Gender for the HR – RM Pair Interview with the Cross Validated Classification

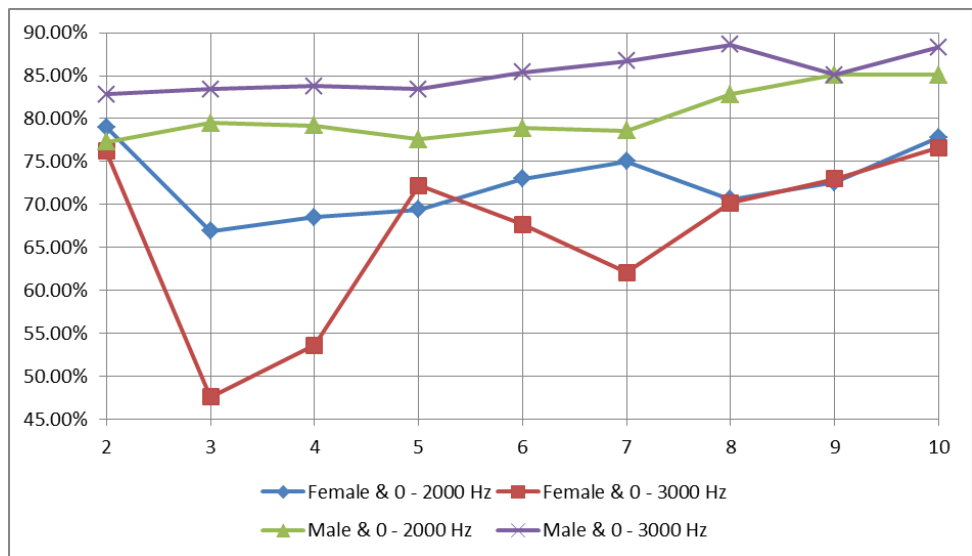

Figure 338: Comparison of the Gender for the HR – RM Pair Interview with the Quadratic Classification

Figure 339 shows the results of the linear classifier for the HR-RM (High Risk Suicidal-Remitted) pairwise group during the reading session; Figure 340 shows the results of the cross validated classifier for the HR-RM (High Risk Suicidal-Remitted) pairwise group during the reading session; Figure 341 shows the results of the quadratic classifier for the HR-RM (High Risk Suicidal-Remitted) pairwise group during the reading session. It can be observed from the graph that the classification rates for 2, 3, 4 and 5 bands are consistently high for the male patients in the 0 – 3000Hz frequency range.

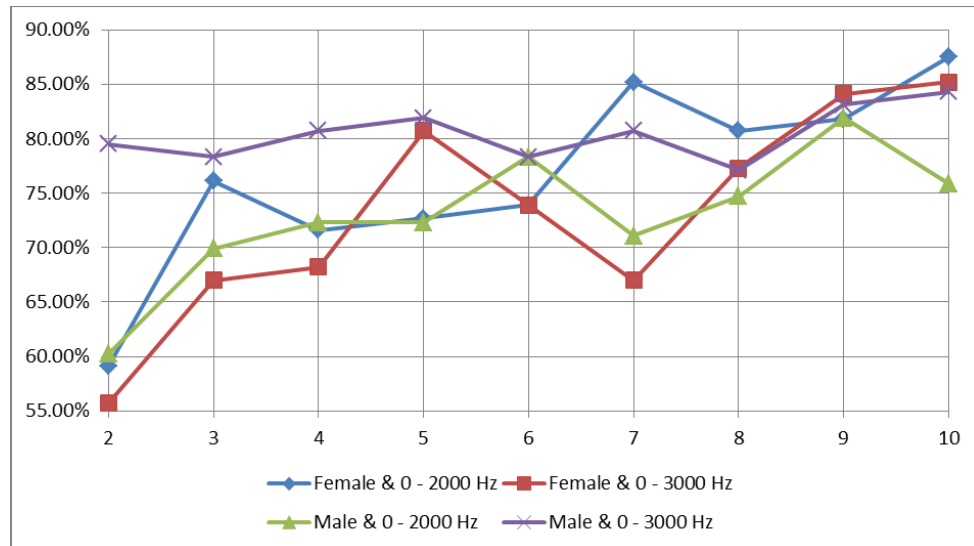

Figure 339: Comparison of the Gender for the HR – RM Pair Reading with the Linear Classification

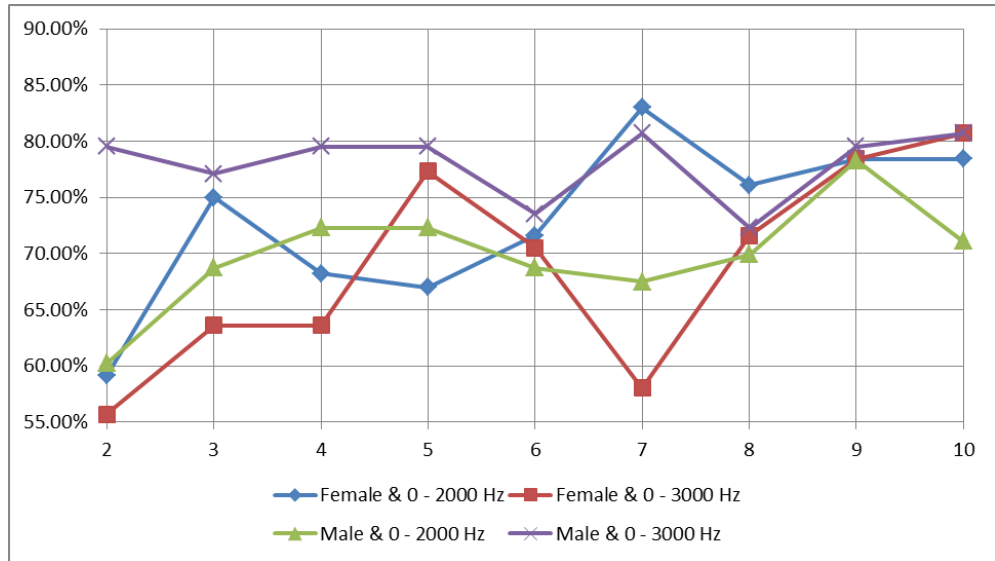

Figure 340: Comparison of the Gender for the HR – RM Pair Reading with the Cross Validated Classification

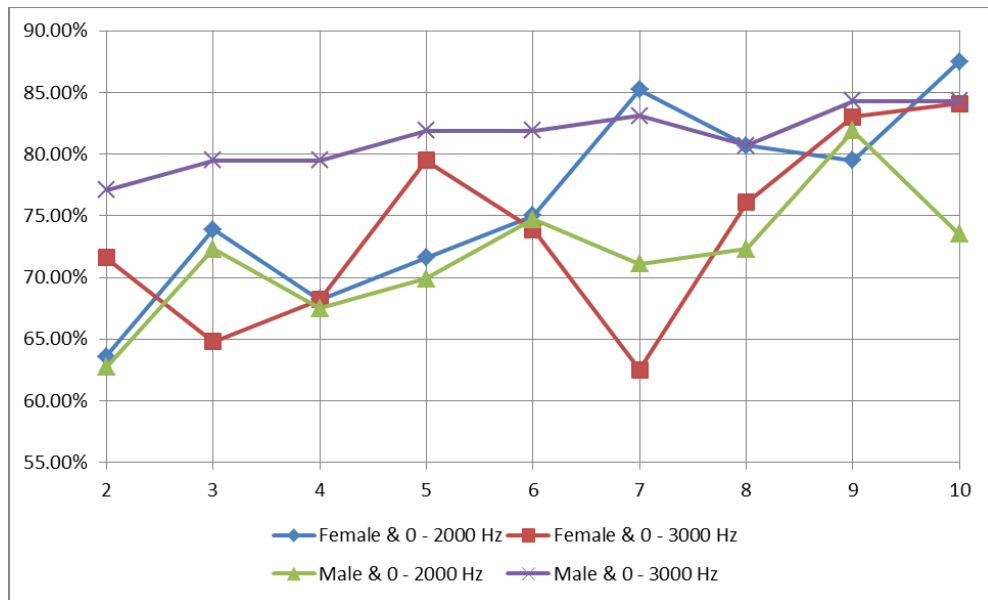

Figure 341: Comparison of the Gender for the HR – RM Pair Reading with the Quadratic Classification

For all of the pairwise groups' (the DP-HR pairwise group, the DP-RM pairwise group, and the HR-RM pairwise group) results during the reading session, it can be observed from the graph that the classification rates for 2, 3, 4 and 5 bands are consistently high for the male patients in the 0 – 3000Hz frequency range.

Statistically Significant Gender Differences

In this part of the research, statistically significant gender differences will be analyzed. First, the mean values of each energy bands for all type of groups (depressed, high risk suicidal, remitted) are calculated. This step is completed for the female patients and the male patients during the interview session and the reading session with different energy band numbers.

Afterwards, the statistically significant features are analyzed using the t-Test. Finally, the energy bands mean shifts are checked and the statistically significant energy bands which are shifting different directions for female and male patients are found. These energy bands are the statistically significant features whose means move different directions when different patient groups are compared.

Results for the 0 – 2000 Hz Band Range

Results of 2 Energy Bands in the 0 – 2000 Hz Frequency Range

The mean values of two energy bands in the 0-2000 Hz frequency range for all the patient groups are calculated. This step is completed for the female patients and the male patients during the interview session and the reading session with 2 energy band numbers. The results are shown in Table 104.

Table 104: Mean Energy Band Values for 2 bands & 0 – 2000 Hz

	FEMALE INTERVIEW			FEMALE READING		
	Suicidal Mean	Depressed Mean	Remitted Mean	Suicidal Mean	Depressed Mean	Remitted Mean
PSD 1	0.964267683	0.969992977	0.956757226	0.969749974	0.973453583	0.959796631
PSD 2	0.035732317	0.030007023	0.043242774	0.030250026	0.026546417	0.040203369
	MALE INTERVIEW			MALE READING		
	Suicidal Mean	Depressed Mean	Remitted Mean	Suicidal Mean	Depressed Mean	Remitted Mean
PSD 1	0.978802454	0.952273745	0.95963878	0.973771286	0.956970477	0.960097365
PSD 2	0.021197546	0.047726255	0.04036122	0.026228714	0.043029523	0.039902635

The table below shows the t-Test results. According to this test, PSD 1 and PSD 2 are the statistically significant features for the DP-HR pairwise group and the HR-RM for male patients during the interview session and the reading session. For the DP-RM pairwise group, PSD 2 is the statistically significant feature for the interview session of both female and male patients. These results are shown in Table 105 and the statistically significant features are highlighted in yellow.

Table 105: Comparison of Significance Results for 2 bands & 0 – 2000 Hz

DP - HR FEMALE INTERVIEW			DP - HR MALE INTERVIEW			DP - HR FEMALE READING			DP - HR MALE READING		
	h	Significance		h	Significance		h	Significance		h	Significance
PSD 1	0	0.0527	PSD 1	1	0.00E+00	PSD 1	0	0.3668	PSD 1	1	1.76E-05
PSD 2	0	5.27E-02	PSD 2	1	0.00E+00	PSD 2	0	0.3668	PSD 2	1	1.76E-05
DP - RM FEMALE INTERVIEW			DP - RM MALE INTERVIEW			DP - RM FEMALE READING			DP - RM MALE READING		
	h	Significance		h	Significance		h	Significance		h	Significance
PSD 1	0	5.10E-01	PSD 1	1	5.50E-01	PSD 1	1	3.90E-04	PSD 1	0	0.4314
PSD 2	1	8.12E-09	PSD 2	1	1.60E-03	PSD 2	1	3.90E-04	PSD 2	0	0.4314
HR - RM FEMALE INTERVIEW			HR - RM MALE INTERVIEW			HR - RM FEMALE READING			HR - RM MALE READING		
	h	Significance		h	Significance		h	Significance		h	Significance
PSD 1	0	5.51E-02	PSD 1	1	0.00E+00	PSD 1	0	6.53E-02	PSD 1	1	6.02E-05
PSD 2	0	5.51E-02	PSD 2	1	0.00E+00	PSD 2	0	6.53E-02	PSD 2	1	6.02E-05

The table below (Table 106) shows the mean value shifts. The statistically significant features are highlighted in yellow and the red colored font indicates the features whose averages move in different directions for the female patients and the male

patients. PSD 2 in the DP-RM interview session is the statistically significant feature whose mean values move in different directions.

Table 106: Comparison of the Mean Value Shifts of Female and Male Patients for 2 bands & 0 – 2000 Hz

FEMALE The shift between Suicidal, Depressed (HR→ DP)					MALE The shift between Suicidal, Depressed (HR→ DP)				
	Interview				Reading				
PSD 1	0.005725294	increase	right	0.004	increase	right			
PSD 2	0.005725294	decrease	left	0.004	decrease	left			
FEMALE The shift between Depressed, Remitted (DP → RM)					MALE The shift between Depressed, Remitted (DP→ RM)				
	Interview				Reading				
PSD 1	0.013235751	decrease	left	0.014	decrease	left			
PSD 2	0.013235751	increase	right	0.014	increase	right			
FEMALE The shift between Suicidal, Remitted (HR→ RM)					MALE The shift between Suicidal, Remitted (HR → RM)				
	Interview				Reading				
PSD 1	0.007510457	decrease	left	0.01	decrease	left			
PSD 2	0.007510457	increase	right	0.01	increase	right			

Results of 3 Energy Bands in the 0 – 2000 Hz Frequency Range

Table 107 shows the mean values of three energy bands in the 0-2000 Hz frequency range for all the patient groups. The mean values are calculated for the female patients and the male patients during the interview session and the reading session with 3 energy band numbers.

Table 107: Mean Energy Band Values for 3 bands & 0 – 2000 Hz

	FEMALE INTERVIEW			FEMALE READING		
	Suicidal Mean	Depressed Mean	Remitted Mean	Suicidal Mean	Depressed Mean	Remitted Mean
PSD 1	0.93245628	0.923250094	0.901036828	0.938267908	0.92518804	0.906685498
PSD 2	0.04659927	0.058167778	0.072218876	0.043468084	0.058906097	0.067266653
PSD 3	0.020944449	0.018582128	0.026744295	0.018264008	0.015905864	0.026047849
	MALE INTERVIEW			MALE READING		
	Suicidal Mean	Depressed Mean	Remitted Mean	Suicidal Mean	Depressed Mean	Remitted Mean
PSD 1	0.942216063	0.914719129	0.910814069	0.939258082	0.925123868	0.916385156
PSD 2	0.045465608	0.05765259	0.062756841	0.044798892	0.047476588	0.056783537
PSD 3	0.012318329	0.02762828	0.02642909	0.015943026	0.027399544	0.026831307

Table 108 shows the t-Test results, and the statistically significant features are highlighted in yellow. According to this test, all three energy bands (PSD 1, PSD 2, and PSD 3) are statistically significant features for the male DP-HR pairwise group during the interview session, for the female DP-RM pairwise group during the interview session, for the female HR-RM pairwise group during both the interview and the reading sessions, and for the male HR-RM pairwise group during both the interview and the reading sessions. PSD 1 and PSD 3 are statistically significant features for the male DP-HR pairwise group during the reading session and for the female DP-RM pairwise group during the reading session. PSD 2 is the statistically significant feature for the female DP-HR pairwise group during both the interview and the reading sessions, and for the male DP-RM pairwise group during both the interview and the reading sessions.

Table 108: Comparison of Significance Results for 3 bands & 0 – 2000 Hz

DP - HR FEMALE INTERVIEW			DP - HR MALE INTERVIEW			DP - HF FEMALE READING			DP - HF MALE READING		
	h	Significance		h	Significance		h	Significance		h	Significance
PSD 1	0	0.0565	PSD 1	1	4.06E-11	PSD 1	0	0.0649	PSD 1	1	0.007
PSD 2	1	7.14E-04	PSD 2	1	5.39E-04	PSD 2	1	0.0023	PSD 2	0	0.4999
PSD 3	0	0.2268	PSD 3	1	0	PSD 3	0	0.4006	PSD 3	1	6.26E-05
DP - RM FEMALE INTERVIEW			DP - RM MALE INTERVIEW			DP - RM FEMALE READING			DP - RM MALE READING		
	h	Significance		h	Significance		h	Significance		h	Significance
PSD 1	1	8.03E-07	PSD 1	0	0.2234	PSD 1	1	0.0093	PSD 1	0	0.1013
PSD 2	1	2.42E-05	PSD 2	1	0.0334	PSD 2	0	0.1043	PSD 2	1	0.0106
PSD 3	1	2.86E-07	PSD 3	0	0.4278	PSD 3	1	1.68E-04	PSD 3	0	0.8441
HR - RM FEMALE INTERVIEW			HR - RM MALE INTERVIEW			HR - RM FEMALE READING			HR - RM MALE READING		
	h	Significance		h	Significance		h	Significance		h	Significance
PSD 1	1	7.12E-07	PSD 1	1	6.66E-16	PSD 1	1	2.35E-04	PSD 1	1	2.86E-04
PSD 2	1	1.61E-09	PSD 2	1	4.69E-07	PSD 2	1	7.69E-06	PSD 2	1	0.021
PSD 3	1	0.0215	PSD 3	1	0	PSD 3	1	0.035	PSD 3	1	1.56E-05

The table below (Table 109) shows the mean value shifts. The statistically significant features are highlighted in yellow. There are no statistically significant features whose averages move in different directions for the female patients and the male patients. Therefore, there aren't any gender specific differences for 3 bands in the 0-2000 Hz frequency range.

Table 109: Comparison of Shifts of Female and Male Patients for 3 bands & 0 – 2000 Hz

FEMALE The shift between Suicidal, Depressed (HR--> DP)			MALE The shift between Suicidal, Depressed (HR--> DP)		
	Interview	Reading		Interview	Reading
PSD 1	0.0092 decrease left	0.0131 decrease left	PSD 1	0.0275 decrease left	0.0141 decrease left
PSD 2	0.0116 increase right	0.0154 increase right	PSD 2	0.0122 increase right	0.0027 increase right
PSD 3	0.0024 decrease left	0.0024 decrease left	PSD 3	0.0153 increase right	0.0115 increase right
FEMALE The shift between Depressed, Remitted (DP --> RM)			MALE The shift between Depressed, Remitted (DP--> RM)		
	Interview	Reading		Interview	Reading
PSD 1	0.0222 decrease left	0.0185 decrease left	PSD 1	0.0039 decrease left	0.0087 decrease left
PSD 2	0.0141 increase right	0.0084 increase right	PSD 2	0.0051 increase right	0.0093 increase right
PSD 3	0.0082 increase right	0.0101 increase right	PSD 3	0.0012 decrease left	0.0006 decrease left
FEMALE The shift between Suicidal, Remitted (HR--> RM)			MALE The shift between Suicidal, Remitted (HR--> RM)		
	Interview	Reading		Interview	Reading
PSD 1	0.0314 decrease left	0.0316 decrease left	PSD 1	0.0314 decrease left	0.0229 decrease left
PSD 2	0.0256 increase right	0.0238 increase right	PSD 2	0.0173 increase right	0.012 increase right
PSD 3	0.0058 increase right	0.0078 increase right	PSD 3	0.0141 increase right	0.0109 increase right

Results of 4 Energy Bands in the 0 – 2000 Hz Frequency Range

In this part of the research, the mean values of the 4 energy bands in the 0-2000 Hz frequency range for the entire patient groups are examined for the female patients and the male patients during the interview session and the reading session. The results are shown in Table 110.

Table 110: Mean Energy Band Values for 4 bands & 0 – 2000 Hz

	FEMALE INTERVIEW			FEMALE READING		
	Suicidal Mean	Depressed Mean	Remitted Mean	Suicidal Mean	Depressed Mean	Remitted Mean
PSD 1	0.881013375	0.849130424	0.812916652	0.870032816	0.844166667	0.812118688
PSD 2	0.083254309	0.120862553	0.143840574	0.099717158	0.129286916	0.147677944
PSD 3	0.019709003	0.015528556	0.022833435	0.016526079	0.014326465	0.020574162
PSD 4	0.016023314	0.014478466	0.020409339	0.013723947	0.012219952	0.019629207
	MALE INTERVIEW			MALE READING		
	Suicidal Mean	Depressed Mean	Remitted Mean	Suicidal Mean	Depressed Mean	Remitted Mean
PSD 1	0.86036008	0.833343963	0.807300002	0.852591863	0.847953991	0.809417091
PSD 2	0.118442374	0.118929782	0.152338778	0.121179423	0.109016486	0.150680274
PSD 3	0.012488258	0.028472303	0.020407764	0.01487327	0.022103644	0.0191745
PSD 4	0.008709288	0.019253952	0.019953455	0.011355444	0.020925879	0.020728134

The Table 111 shows the t-Test results. For the female DP-HR pairwise group during the interview session and for the male DP-RM pairwise group during the

interview session; PSD 1, PSD 2, and PSD 3 are the statistically significant features. PSD 1, PSD 3, and PSD 4 are the statistically significant features for the male DP-HR pairwise group during the interview session and for the female DP-RM pairwise group during the reading session. All four energy bands are statistically significant features for the female DP-RM pairwise group during the interview session, for the male HR-RM pairwise group during the interview session and for the male HR-RM pairwise group during the reading session. PSD 1, PSD 2, and PSD 4 are the statistically significant features for the female HR-RM pairwise group during the interview session and the reading session. For the female DP-HR pairwise group during the reading session and for the male DP-RM pairwise group during the reading session; PSD 1 and PSD 2 are the statistically significant features. PSD 3 and PSD 4 are the statistically significant features for the male DP-HR pairwise group during the reading session. These results are shown in Table 11 and the statistically significant features are highlighted in yellow.

Table 111: Comparison of Significance Results for 4 bands & 0 – 2000 Hz

DP - HR FEMALE INTERVIEW			DP - HR MALE INTERVIEW			DP - HR FEMALE READING			DP - HR MALE READING		
	h	Significance		h	Significance		h	Significance		h	Significance
PSD 1	1	1.40E-04	PSD 1	1	9.30E-06	PSD 1	1	0.0214	PSD 1	0	0.6192
PSD 2	1	3.83E-08	PSD 2	0	9.27E-01	PSD 2	1	0.001	PSD 2	0	0.1521
PSD 3	1	0.0048	PSD 3	1	0	PSD 3	0	0.2855	PSD 3	1	5.86E-05
PSD 4	0	0.3344	PSD 4	1	0.00E+00	PSD 4	0	0.5157	PSD 4	1	3.79E-05
DP - RM FEMALE INTERVIEW			DP - RM MALE INTERVIEW			DP - RM FEMALE READING			DP - RM MALE READING		
	h	Significance		h	Significance		h	Significance		h	Significance
PSD 1	1	1.37E-05	PSD 1	1	7.43E-06	PSD 1	1	0.0128	PSD 1	1	6.18E-04
PSD 2	1	7.24E-04	PSD 2	1	5.40E-11	PSD 2	0	0.073	PSD 2	1	1.60E-05
PSD 3	1	7.49E-10	PSD 3	1	2.33E-08	PSD 3	1	2.00E-03	PSD 3	0	0.1138
PSD 4	1	6.85E-06	PSD 4	0	0.5454	PSD 4	1	6.71E-04	PSD 4	0	0.9334
HR - RM FEMALE INTERVIEW			HR - RM MALE INTERVIEW			HR - RM FEMALE READING			HR - RM MALE READING		
	h	Significance		h	Significance		h	Significance		h	Significance
PSD 1	1	8.30E-11	PSD 1	1	0.00E+00	PSD 1	1	3.15E-05	PSD 1	1	1.70E-03
PSD 2	1	2.18E-14	PSD 2	1	2.82E-11	PSD 2	1	1.63E-06	PSD 2	1	0.0172
PSD 3	0	0.1344	PSD 3	1	1.11E-16	PSD 3	0	0.1313	PSD 3	1	8.10E-03
PSD 4	1	3.24E-02	PSD 4	1	0.00E+00	PSD 4	1	4.19E-02	PSD 4	1	2.42E-06

Table 112 shows the mean value shifts. The statistically significant features are highlighted in yellow and the red colored font indicates the features whose averages move in different directions for the female patients and the male patients. The PSD 3 in the HR-DP interview session and the PSD 3 in the DP-RM interview session are the statistically significant features whose mean values move in different directions.

Table 112: Comparison of Shifts of Female and Male Patients for 4 bands & 0 – 2000 Hz

FEMALE The shift between Suicidal, Depressed (HR--> DP)				MALE The shift between Suicidal, Depressed (HR--> DP)					
	Interview		Reading			Interview		Reading	
PSD 1	0.0319	decrease left	0.0259	decrease left	PSD 1	0.027	decrease left	0.0046	decrease left
PSD 2	0.0376	increase right	0.0296	increase right	PSD 2	0.0005	increase right	0.0122	decrease left
PSD 3	0.0042	decrease left	0.0022	decrease left	PSD 3	0.016	increase right	0.0072	increase right
PSD 4	0.0015	decrease left	0.0015	decrease left	PSD 4	0.0105	increase right	0.0096	increase right
FEMALE The shift between Depressed, Remitted (DP--> RM)				MALE The shift between Depressed, Remitted (DP--> RM)					
	Interview		Reading			Interview		Reading	
PSD 1	0.0362	decrease left	0.032	decrease left	PSD 1	0.026	decrease left	0.0385	decrease left
PSD 2	0.023	increase right	0.0184	increase right	PSD 2	0.0334	increase right	0.0417	increase right
PSD 3	0.0073	increase right	0.0062	increase right	PSD 3	0.0081	decrease left	0.0029	decrease left
PSD 4	0.0059	increase right	0.0074	increase right	PSD 4	0.0007	increase right	0.0002	decrease left
FEMALE The shift between Suicidal, Remitted (HR--> RM)				MALE The shift between Suicidal, Remitted (HR --> RM)					
	Interview		Reading			Interview		Reading	
PSD 1	0.0681	decrease left	0.0579	decrease left	PSD 1	0.0531	decrease left	0.0432	decrease left
PSD 2	0.0606	increase right	0.048	increase right	PSD 2	0.0339	increase right	0.0295	increase right
PSD 3	0.0031	increase right	0.004	increase right	PSD 3	0.0079	increase right	0.0043	increase right
PSD 4	0.0044	increase right	0.0059	increase right	PSD 4	0.0112	increase right	0.0094	increase right

Results of 5 Energy Bands in the 0 – 2000 Hz Frequency Range

The mean values of five energy bands in the 0-2000 Hz frequency range for all the patient groups are determined and shown in Table 113. This table shows the results for the female patients and the male patients during the interview session and the reading session with 5 energy band numbers.

Table 113: Mean Energy Band Values for 5 bands & 0 – 2000 Hz

	FEMALE INTERVIEW			FEMALE READING		
	Suicidal Mean	Depressed Mean	Remitted Mean	Suicidal Mean	Depressed Mean	Remitted Mean
PSD 1	0.808200537	0.771322379	0.734776448	0.77005403	0.75876854	0.725798323
PSD 2	0.141591836	0.17916249	0.198104905	0.187134441	0.195387058	0.213464165
PSD 3	0.024044652	0.027634533	0.035433073	0.020616611	0.026945846	0.030192549
PSD 4	0.013316732	0.010342301	0.015862917	0.011356543	0.00901595	0.014955286
PSD 5	0.012846244	0.011538297	0.015822657	0.010838376	0.009882606	0.015589677
	MALE INTERVIEW			MALE READING		
	Suicidal Mean	Depressed Mean	Remitted Mean	Suicidal Mean	Depressed Mean	Remitted Mean
PSD 1	0.769286951	0.747669453	0.703758847	0.755625125	0.745999552	0.685475148
PSD 2	0.195750654	0.189113663	0.237895557	0.205348989	0.198303523	0.260029953
PSD 3	0.019311537	0.028003916	0.027099855	0.019651621	0.022831931	0.023078937
PSD 4	0.008908811	0.020192647	0.01536954	0.010651513	0.015914497	0.015026957
PSD 5	0.006742046	0.015020321	0.015876202	0.008722751	0.016950498	0.016389005

For the female DP-HR pairwise group during the interview session; PSD 1, PSD 2, PSD 3 and PSD 4 are the statistically significant features. The PSD 1, PSD 3, PSD 4 and PSD 5 are the statistically significant features for the male DP-HR pairwise group during the interview session. All five energy bands are the statistically significant features for the female DP-RM pairwise group during the interview session and for the male HR-RM pairwise group during the interview session. The PSD 1, PSD 2, and PSD 4 are the statistically significant features for the male DP-RM pairwise group during the interview session. The PSD 1, PSD 2, and PSD 3 are the statistically significant features for the female HR-RM pairwise group during the interview session.

For the female DP-HR pairwise group during the reading session, PSD 3 is the only statistically significant feature. The PSD 4 and PSD 5 are the statistically significant features for the male DP-HR pairwise group during the reading session and for the female DP-RM pairwise group during the reading session. PSD 1 and PSD 2 are the statistically significant features for the male DP-RM pairwise group during the reading session. The PSD 1, PSD 3, and PSD 5 are the statistically significant features for the female HR-RM pairwise group during the reading session. PSD 1, PSD 2, PSD 4, and PSD 5 are the statistically significant features for the male HR-RM pairwise group during the reading session. All of the results are shown in Table 114 and the statistically significant features are highlighted in yellow.

Table 114: Comparison of Significance Results for 5 bands & 0 – 2000 Hz

DP - HR	FEMALE INTERVIEW		DP - HR	MALE INTERVIEW		DP - HR	FEMALE READING		DP - HR	MALE READING	
	h	Significance		h	Significance		h	Significance		h	Significance
PSD 1	1	0.0019	PSD 1	1	0.0036	PSD 1	0	0.4442	PSD 1	0	0.4422
PSD 2	1	1.37E-04	PSD 2	0	0.2654	PSD 2	0	0.4914	PSD 2	0	0.5419
PSD 3	1	0.0435	PSD 3	1	6.61E-06	PSD 3	1	0.019	PSD 3	0	0.1258
PSD 4	1	0.007	PSD 4	1	0	PSD 4	0	0.1141	PSD 4	1	1.35E-04
PSD 5	0	0.3038	PSD 5	1	0	PSD 5	0	0.6164	PSD 5	1	2.36E-05
DP - RM	FEMALE INTERVIEW		DP - RM	MALE INTERVIEW		DP - RM	FEMALE READING		DP - RM	MALE READING	
	h	Significance		h	Significance		h	Significance		h	Significance
PSD 1	1	0.0016	PSD 1	1	1.03E-06	PSD 1	0	0.0562	PSD 1	1	2.33E-04
PSD 2	1	0.0426	PSD 2	1	3.50E-09	PSD 2	0	0.1873	PSD 2	1	2.75E-05
PSD 3	1	1.26E-05	PSD 3	0	0.5159	PSD 3	0	0.2365	PSD 3	0	0.8796
PSD 4	1	6.63E-10	PSD 4	1	3.92E-06	PSD 4	1	8.08E-05	PSD 4	0	0.5457
PSD 5	1	1.59E-05	PSD 5	0	0.3676	PSD 5	1	0.0015	PSD 5	0	0.7741
HR - RM	FEMALE INTERVIEW		HR - RM	MALE INTERVIEW		HR - RM	FEMALE READING		HR - RM	MALE READING	
	h	Significance		h	Significance		h	Significance		h	Significance
PSD 1	1	1.42E-07	PSD 1	1	3.83E-13	PSD 1	1	0.0171	PSD 1	1	8.43E-04
PSD 2	1	1.63E-07	PSD 2	1	8.94E-08	PSD 2	0	0.0722	PSD 2	1	0.0039
PSD 3	1	4.44E-06	PSD 3	1	1.06E-05	PSD 3	1	9.86E-04	PSD 3	0	0.119
PSD 4	0	0.0893	PSD 4	1	0	PSD 4	0	0.0766	PSD 4	1	0.0017
PSD 5	0	0.0608	PSD 5	1	0	PSD 5	1	0.0422	PSD 5	1	5.89E-07

Table 115: Comparison of Shifts of Female and Male Patients for 5 bands & 0 – 2000 Hz

FEMALE The shift between Suicidal, Depressed (HR→ DP)				MALE The shift between Suicidal, Depressed (HR→ DP)			
Interview		Reading		Interview		Reading	
PSD 1	0.0369 decrease left	0.0113 decrease left	0.0096 decrease left	PSD 1	0.0216 decrease left	0.0096 decrease left	0.0096 decrease left
PSD 2	0.0376 increase right	0.0083 increase right	0.007 decrease left	PSD 2	0.0066 decrease left	0.007 decrease left	0.007 decrease left
PSD 3	0.0036 increase right	0.0063 increase right	0.0032 increase right	PSD 3	0.0087 increase right	0.0032 increase right	0.0032 increase right
PSD 4	0.003 decrease left	0.0023 decrease left	0.0053 increase right	PSD 4	0.0113 increase right	0.0053 increase right	0.0053 increase right
PSD 5	0.0013 decrease left	0.001 decrease left	0.0082 increase right	PSD 5	0.0083 increase right	0.0082 increase right	0.0082 increase right
FEMALE The shift between Depressed, Remitted (DP→ RM)				MALE The shift between Depressed, Remitted (DP→ RM)			
Interview		Reading		Interview		Reading	
PSD 1	0.0365 decrease left	0.033 decrease left	0.0605 decrease left	PSD 1	0.0439 decrease left	0.0605 decrease left	0.0605 decrease left
PSD 2	0.0189 increase right	0.0181 increase right	0.0617 increase right	PSD 2	0.0488 increase right	0.0617 increase right	0.0617 increase right
PSD 3	0.0078 increase right	0.0032 increase right	0.0002 increase right	PSD 3	0.0009 decrease left	0.0002 increase right	0.0002 increase right
PSD 4	0.0055 increase right	0.0059 increase right	0.0009 decrease left	PSD 4	0.0048 decrease left	0.0009 decrease left	0.0009 decrease left
PSD 5	0.0043 increase right	0.0057 increase right	0.0006 decrease left	PSD 5	0.0009 increase right	0.0006 decrease left	0.0006 decrease left
FEMALE The shift between Suicidal, Remitted (HR → RM)				MALE The shift between Suicidal, Remitted (HR→ RM)			
Interview		Reading		Interview		Reading	
PSD 1	0.0734 decrease left	0.0443 decrease left	0.0701 decrease left	PSD 1	0.0655 decrease left	0.0701 decrease left	0.0701 decrease left
PSD 2	0.0565 increase right	0.0263 increase right	0.0547 increase right	PSD 2	0.0421 increase right	0.0547 increase right	0.0547 increase right
PSD 3	0.0114 increase right	0.0096 increase right	0.0034 increase right	PSD 3	0.0078 increase right	0.0034 increase right	0.0034 increase right
PSD 4	0.0025 increase right	0.0036 increase right	0.0044 increase right	PSD 4	0.0065 increase right	0.0044 increase right	0.0044 increase right
PSD 5	0.003 increase right	0.0048 increase right	0.0077 increase right	PSD 5	0.0091 increase right	0.0077 increase right	0.0077 increase right

Table 115 above shows the mean value shifts. The statistically significant features are highlighted in yellow and the red colored font indicates the features whose averages move in different directions for the female patients and the male patients. The PSD 4 in

the HR-DP interview session and the PSD 4 in the DP-RM interview sessions are the statistically significant features whose mean values move in different directions.

Results of 6 Energy Bands in the 0 – 2000 Hz Frequency Range

In this part of the research, the mean values of the 6 energy bands in the 0-2000 Hz frequency range for all the patient groups are observed for the female patients and the male patients during the interview session and the reading session. The results are shown in Table 116.

Table 116: Mean Energy Band Values for 6 bands & 0 – 2000 Hz

	FEMALE INTERVIEW			FEMALE READING		
	Suicidal Mean	Depressed Mean	Remitted Mean	Suicidal Mean	Depressed Mean	Remitted Mean
PSD 1	0.749595262	0.711387867	0.670654177	0.695333739	0.692695634	0.658647196
PSD 2	0.182861019	0.211862227	0.230382651	0.242934169	0.232492406	0.248038301
PSD 3	0.031811403	0.046742884	0.055720397	0.031482065	0.048265544	0.053111134
PSD 4	0.014787868	0.011424895	0.016498479	0.011986018	0.010640553	0.014155519
PSD 5	0.01012994	0.009193844	0.014601339	0.008987789	0.00737609	0.013170253
PSD 6	0.010814509	0.009388284	0.012142956	0.009276219	0.008529773	0.012877596
	MALE INTERVIEW			MALE READING		
	Suicidal Mean	Depressed Mean	Remitted Mean	Suicidal Mean	Depressed Mean	Remitted Mean
PSD 1	0.714656475	0.689448078	0.643252341	0.692391354	0.677153921	0.609684405
PSD 2	0.227559588	0.225271051	0.267561729	0.246866727	0.247969947	0.306700751
PSD 3	0.036586391	0.037554616	0.048824711	0.034513204	0.031846609	0.043712209
PSD 4	0.008879217	0.020097974	0.01393213	0.010285688	0.015629979	0.013071328
PSD 5	0.007039576	0.015904498	0.013368576	0.009238972	0.013653453	0.013215722
PSD 6	0.005278753	0.011723782	0.013060514	0.006704054	0.013746091	0.013615585

The table below, Table 117, shows the t-Test results. For the female DP-HR pairwise group during the interview session; PSD 1, PSD 2, PSD 3 and PSD 4 are the statistically significant features. The PSD 1, PSD 4, PSD 5 and PSD 6 are the statistically significant features for the male DP-HR pairwise group during the interview session. PSD 1, PSD 3, PSD 4, PSD 5, and PSD 6 are the statistically significant features for the female DP-RM pairwise group during the interview session. The first five energy bands

are the statistically significant features for the male DP-RM pairwise group during the interview session. PSD 1, PSD 2, PSD 3, and PSD 5 are the statistically significant features for the female HR-RM pairwise group during the interview session. All six energy bands are statistically significant features for the male HR-RM pairwise group during the interview session.

Table 117: Comparison of Significance Results for 6 bands & 0 – 2000 Hz

DP - HR FEMALE INTERVIEW			DP - HR MALE INTERVIEW			DP - HR FEMALE READING			DP - HR MALE READING		
	h	Significance		h	Significance		h	Significance		h	Significance
PSD 1	1	0.0057	PSD 1	1	0.0027	PSD 1	0	0.8778	PSD 1	0	0.3166
PSD 2	1	0.0062	PSD 2	0	0.703	PSD 2	0	0.4465	PSD 2	0	0.9355
PSD 3	1	5.91E-08	PSD 3	0	0.7478	PSD 3	1	6.45E-05	PSD 3	0	0.4699
PSD 4	1	0.0026	PSD 4	1	0	PSD 4	0	0.3719	PSD 4	1	4.30E-05
PSD 5	0	0.3694	PSD 5	1	0	PSD 5	0	0.1662	PSD 5	1	9.32E-04
PSD 6	0	0.1839	PSD 6	1	0	PSD 6	0	0.6805	PSD 6	1	1.92E-05
DP - RM FEMALE INTERVIEW			DP - RM MALE INTERVIEW			DP - RM FEMALE READING			DP - RM MALE READING		
	h	Significance		h	Significance		h	Significance		h	Significance
PSD 1	1	0.0019	PSD 1	1	1.36E-05	PSD 1	0	0.0811	PSD 1	1	3.89E-04
PSD 2	0	0.0583	PSD 2	1	2.03E-05	PSD 2	0	0.2964	PSD 2	1	5.06E-04
PSD 3	1	9.28E-04	PSD 3	1	1.60E-08	PSD 3	0	0.2606	PSD 3	1	4.61E-04
PSD 4	1	1.24E-08	PSD 4	1	8.01E-09	PSD 4	1	0.0142	PSD 4	0	0.0547
PSD 5	1	5.36E-07	PSD 5	1	0.0021	PSD 5	1	1.71E-05	PSD 5	0	0.7452
PSD 6	1	1.48E-04	PSD 6	0	0.0877	PSD 6	1	0.0055	PSD 6	0	0.9379
HR - RM FEMALE INTERVIEW			HR - RM MALE INTERVIEW			HR - RM FEMALE READING			HR - RM MALE READING		
	h	Significance		h	Significance		h	Significance		h	Significance
PSD 1	1	4.82E-07	PSD 1	1	5.26E-11	PSD 1	0	0.0829	PSD 1	1	9.06E-04
PSD 2	1	1.48E-04	PSD 2	1	2.23E-05	PSD 2	0	0.761	PSD 2	1	0.0056
PSD 3	1	4.92E-14	PSD 3	1	7.34E-05	PSD 3	1	2.08E-08	PSD 3	0	0.0701
PSD 4	0	0.2824	PSD 4	1	9.43E-13	PSD 4	0	0.251	PSD 4	1	0.0117
PSD 5	1	0.0025	PSD 5	1	0	PSD 5	1	0.0172	PSD 5	1	0.0038
PSD 6	0	0.3027	PSD 6	1	0	PSD 6	0	0.0751	PSD 6	1	1.55E-07

For the female DP-HR pairwise group during the reading session, PSD 3 is the only statistically significant feature. PSD 4, PSD 5, and PSD 6 are the statistically significant features for the male DP-HR pairwise group during the reading session and for the female DP-RM pairwise group during the reading session. PSD 1, PSD 2, and PSD 3 are the statistically significant features for the male DP-RM pairwise group during the reading session. PSD 3 and PSD 5 are the statistically significant features for the

female HR-RM pairwise group during the reading session. PSD 1, PSD 2, PSD 4, PSD 5, and PSD 6 are the statistically significant features for the male HR-RM pairwise group during the reading session. All of the results are shown in Table 117 above and the statistically significant features are highlighted in yellow.

Table 118 shows the mean value shifts. The statistically significant features are highlighted in yellow and the red colored font indicates the features whose averages move in different directions for the female patients and the male patients. PSD 4 in the DP-HR interview session, and PSD 4 and the PSD 5 in the DP-RM interview session are the statistically significant features whose mean values move in different directions.

Table 118: Comparison of Shifts of Female and Male Patients for 6 bands & 0 – 2000 Hz

FEMALE The shift between Suicidal, Depressed (HR→ DP)				MALE The shift between Suicidal, Depressed (HR→ DP)					
	Interview		Reading			Interview		Reading	
PSD 1	0.0382	decrease left	0.0026	decrease left	PSD 1	0.0252	decrease left	0.0152	decrease left
PSD 2	0.029	increase right	0.0104	decrease left	PSD 2	0.0023	decrease left	0.0011	increase right
PSD 3	0.0149	increase right	0.0168	increase right	PSD 3	0.001	increase right	0.0027	decrease left
PSD 4	0.0034	decrease left	0.0013	decrease left	PSD 4	0.0112	increase right	0.0053	increase right
PSD 5	0.0009	decrease left	0.0016	decrease left	PSD 5	0.0089	increase right	0.0044	increase right
PSD 6	0.0014	decrease left	0.0007	decrease left	PSD 6	0.0064	increase right	0.007	increase right
FEMALE The shift between Depressed, Remitted (DP→ RM)				MALE The shift between Depressed, Remitted (DP→ RM)					
	Interview		Reading			Interview		Reading	
PSD 1	0.0407	decrease left	0.034	decrease left	PSD 1	0.0462	decrease left	0.0675	decrease left
PSD 2	0.0185	increase right	0.0155	increase right	PSD 2	0.0423	increase right	0.0587	increase right
PSD 3	0.009	increase right	0.0048	increase right	PSD 3	0.0113	increase right	0.0119	increase right
PSD 4	0.0051	increase right	0.0035	increase right	PSD 4	0.0062	decrease left	0.0026	decrease left
PSD 5	0.0054	increase right	0.0058	increase right	PSD 5	0.0025	decrease left	0.0004	decrease left
PSD 6	0.0028	increase right	0.0043	increase right	PSD 6	0.0013	increase right	0.0001	decrease left
FEMALE The shift between Suicidal, Remitted (HR → RM)				MALE The shift between Suicidal, Remitted (HR → RM)					
	Interview		Reading			Interview		Reading	
PSD 1	0.0789	decrease left	0.0367	decrease left	PSD 1	0.0714	decrease left	0.0827	decrease left
PSD 2	0.0475	increase right	0.0051	increase right	PSD 2	0.04	increase right	0.0598	increase right
PSD 3	0.0239	increase right	0.0216	increase right	PSD 3	0.0122	increase right	0.0092	increase right
PSD 4	0.0017	increase right	0.0022	increase right	PSD 4	0.0051	increase right	0.0028	increase right
PSD 5	0.0045	increase right	0.0042	increase right	PSD 5	0.0063	increase right	0.004	increase right
PSD 6	0.0013	increase right	0.0036	increase right	PSD 6	0.0078	increase right	0.0069	increase right

Results of 7 Energy Bands in the 0 – 2000 Hz Frequency Range

Table 119 shows the mean values of seven energy bands in the 0-2000 Hz frequency range for all the patient groups. The mean values are found for the female patients and the male patients during the interview session and the reading session with 7 energy band numbers.

Table 119: Mean Energy Band Values for 7 bands & 0 – 2000 Hz

FEMALE INTERVIEW				FEMALE READING		
	Suicidal Mean	Depressed Mean	Remitted Mean	Suicidal Mean	Depressed Mean	Remitted Mean
PSD 1	0.686834204	0.651810245	0.601424817	0.621466192	0.627408695	0.58662299
PSD 2	0.221978061	0.234460403	0.253897457	0.286892739	0.257985611	0.271868537
PSD 3	0.046309831	0.072666406	0.086968398	0.053603	0.077511363	0.089659415
PSD 4	0.01600535	0.017252486	0.0233785	0.013662295	0.016326924	0.018766537
PSD 5	0.010849038	0.007683126	0.011166442	0.008912788	0.007137471	0.010774086
PSD 6	0.008791886	0.008174897	0.012977509	0.007559238	0.006363312	0.011441241
PSD 7	0.009231631	0.007952436	0.010186877	0.007903748	0.007266624	0.010867193
MALE INTERVIEW				MALE READING		
	Suicidal Mean	Depressed Mean	Remitted Mean	Suicidal Mean	Depressed Mean	Remitted Mean
PSD 1	0.667391967	0.629288268	0.588458869	0.637712284	0.611593722	0.545367579
PSD 2	0.236561583	0.246769955	0.272231697	0.260809419	0.279950881	0.321392516
PSD 3	0.067464751	0.066421679	0.088498562	0.068052683	0.057199536	0.085102143
PSD 4	0.011559035	0.019115993	0.017197987	0.012347947	0.015715503	0.014256499
PSD 5	0.006756402	0.015574687	0.010925808	0.007646904	0.011809625	0.010593138
PSD 6	0.005832129	0.013091002	0.0115704	0.007845647	0.01205982	0.011564888
PSD 7	0.004434133	0.009738416	0.011116677	0.005585117	0.011670913	0.011723237

The table below shows the t-Test results. For the female DP-HR pairwise group during the interview session, PSD 1, PSD 3, and PSD 5 are the statistically significant features. PSD 1, PSD 4, PSD 5, PSD 6 and PSD 7 are the statistically significant features for the male DP-HR pairwise group during the interview session. All seven energy bands are statistically significant features for the female DP-RM pairwise group during the interview session. All seven energy bands except PSD 4 are statistically significant features for the male DP-RM pairwise group during the interview session. PSD 1, PSD 2, PSD 3, PSD 4 and PSD 6 are statistically significant features for the female HR-RM

pairwise group during the interview session. All seven energy bands are the statistically significant features for the male HR-RM pairwise group during the interview session.

For the female DP-HR pairwise group during the reading session, the PSD 2 and PSD 3 are the statistically significant features. The PSD 4, PSD 5, PSD 6 and PSD 7 are the statistically significant features for the male DP-HR pairwise group during the reading session. The PSD 1, PSD 5, PSD 6 and PSD 7 are the statistically significant features for the female DP-RM pairwise group during the reading session. The first three energy bands (PSD 1, PSD 2, and PSD 3) are the statistically significant features for the male DP-RM pairwise group during the reading session. The PSD 3, PSD 4, and PSD 6 are the statistically significant features for the female HR-RM pairwise group during the reading session. All seven energy bands except PSD 4 are the statistically significant features for the male HR-RM pairwise group during the reading session. All of the results are shown in Table 120 and the statistically significant features are highlighted in yellow.

Table 120: Comparison of Significance Results for 7 bands & 0 – 2000 Hz

DP - HR FEMALE INTERVIEW			DP - HR MALE INTERVIEW			DP - HR FEMALE READING			DP - HR MALE READING		
	h	Significance		h	Significance		h	Significance		h	Significance
PSD 1	1	0.0187	PSD 1	1	4.61E-05	PSD 1	0	0.7468	PSD 1	0	0.1339
PSD 2	0	0.2052	PSD 2	0	0.0781	PSD 2	1	0.032	PSD 2	0	0.1826
PSD 3	1	6.40E-10	PSD 3	0	0.7752	PSD 3	1	3.80E-05	PSD 3	0	0.0606
PSD 4	0	0.2905	PSD 4	1	6.29E-10	PSD 4	0	0.1337	PSD 4	1	0.0151
PSD 5	1	3.30E-04	PSD 5	1	0	PSD 5	0	0.134	PSD 5	1	2.24E-05
PSD 6	0	0.5345	PSD 6	1	0	PSD 6	0	0.2409	PSD 6	1	7.05E-04
PSD 7	0	0.1727	PSD 7	1	0	PSD 7	0	0.6914	PSD 7	1	2.64E-05
DP - RM FEMALE INTERVIEW			DP - RM MALE INTERVIEW			DP - RM FEMALE READING			DP - RM MALE READING		
	h	Significance		h	Significance		h	Significance		h	Significance
PSD 1	1	3.68E-04	PSD 1	1	4.95E-04	PSD 1	1	0.0488	PSD 1	1	0.0011
PSD 2	1	0.0301	PSD 2	1	0.0111	PSD 2	0	0.3223	PSD 2	1	0.0125
PSD 3	1	5.91E-04	PSD 3	1	1.81E-12	PSD 3	0	0.0556	PSD 3	1	1.07E-05
PSD 4	1	2.91E-07	PSD 4	0	0.0569	PSD 4	0	0.1649	PSD 4	0	0.2084
PSD 5	1	2.08E-08	PSD 5	1	3.02E-08	PSD 5	1	0.0015	PSD 5	0	0.2533
PSD 6	1	5.59E-06	PSD 6	1	0.0314	PSD 6	1	2.95E-05	PSD 6	0	0.6879
PSD 7	1	3.45E-04	PSD 7	1	0.0399	PSD 7	1	0.0076	PSD 7	0	0.9719
HR - RM FEMALE INTERVIEW			HR - RM MALE INTERVIEW			HR - RM FEMALE READING			HR - RM MALE READING		
	h	Significance		h	Significance		h	Significance		h	Significance
PSD 1	1	6.40E-07	PSD 1	1	9.62E-11	PSD 1	0	0.1251	PSD 1	1	6.67E-04
PSD 2	1	0.0052	PSD 2	1	2.37E-04	PSD 2	0	0.3541	PSD 2	1	0.0035
PSD 3	1	0	PSD 3	1	1.63E-09	PSD 3	1	8.94E-10	PSD 3	1	0.0372
PSD 4	1	1.88E-05	PSD 4	1	8.44E-08	PSD 4	1	0.0104	PSD 4	0	0.1244
PSD 5	0	0.7851	PSD 5	1	3.32E-14	PSD 5	0	0.224	PSD 5	1	0.0013
PSD 6	1	0.0031	PSD 6	1	0	PSD 6	1	0.0137	PSD 6	1	0.0022
PSD 7	0	0.3955	PSD 7	1	0	PSD 7	0	0.0886	PSD 7	1	1.56E-07

Table 121 shows the mean value shifts. The statistically significant features are highlighted in yellow and the red colored font indicates the features whose averages move in different directions for female patients and male patients. PSD 5 in the DP-HR interview session; PSD 5 and the PSD 6 in the DP-RM interview session are the statistically significant features whose mean values move in different directions.

Table 121: Comparison of Shifts of Female and Male Patients for 7 bands & 0 – 2000 Hz

FEMALE The shift between Suicidal, Depressed (HR--> DP)				MALE The shift between Suicidal, Depressed (HR--> DP)					
	Interview		Reading			Interview		Reading	
PSD 1	0.035	decrease left	0.0059	increase right	PSD 1	0.0381	decrease left	0.0261	decrease left
PSD 2	0.0125	increase right	0.0289	decrease left	PSD 2	0.0102	increase right	0.0191	increase right
PSD 3	0.0264	increase right	0.0239	increase right	PSD 3	0.001	decrease left	0.0109	decrease left
PSD 4	0.0012	increase right	0.0027	increase right	PSD 4	0.0076	increase right	0.0034	increase right
PSD 5	0.0032	decrease left	0.0018	decrease left	PSD 5	0.0088	increase right	0.0042	increase right
PSD 6	0.0006	decrease left	0.0012	decrease left	PSD 6	0.0073	increase right	0.0042	increase right
PSD 7	0.0013	decrease left	0.0006	decrease left	PSD 7	0.0053	increase right	0.0061	increase right

FEMALE The shift between Depressed, Remitted (DP --> RM)				MALE The shift between Depressed, Remitted (DP--> RM)					
	Interview		Reading			Interview		Reading	
PSD 1	0.0504	decrease left	0.0408	decrease left	PSD 1	0.0408	decrease left	0.0662	decrease left
PSD 2	0.0194	increase right	0.0139	increase right	PSD 2	0.0255	increase right	0.0414	increase right
PSD 3	0.0143	increase right	0.0121	increase right	PSD 3	0.0221	increase right	0.0279	increase right
PSD 4	0.0061	increase right	0.0024	increase right	PSD 4	0.0019	decrease left	0.0015	decrease left
PSD 5	0.0035	increase right	0.0036	increase right	PSD 5	0.0046	decrease left	0.0012	decrease left
PSD 6	0.0048	increase right	0.0051	increase right	PSD 6	0.0015	decrease left	0.0005	decrease left
PSD 7	0.0022	increase right	0.0036	increase right	PSD 7	0.0014	increase right	5E-05	increase right

FEMALE The shift between Suicidal, Remitted (HR --> RM)				MALE The shift between Suicidal, Remitted (HR --> RM)					
	Interview		Reading			Interview		Reading	
PSD 1	0.0854	decrease left	0.0348	decrease left	PSD 1	0.0789	decrease left	0.0923	decrease left
PSD 2	0.0319	increase right	0.015	decrease left	PSD 2	0.0357	increase right	0.0606	increase right
PSD 3	0.0407	increase right	0.0361	increase right	PSD 3	0.021	increase right	0.017	increase right
PSD 4	0.0074	increase right	0.0051	increase right	PSD 4	0.0056	increase right	0.0019	increase right
PSD 5	0.0003	increase right	0.0019	increase right	PSD 5	0.0042	increase right	0.0029	increase right
PSD 6	0.0042	increase right	0.0039	increase right	PSD 6	0.0057	increase right	0.0037	increase right
PSD 7	0.001	increase right	0.003	increase right	PSD 7	0.0067	increase right	0.0061	increase right

Results of 8 Energy Bands in the 0 – 2000 Hz Frequency Range

The mean values of eight energy bands in the 0-2000 Hz frequency range for all the patient groups are calculated. This step is completed for the female patients and the male patients during the interview session and the reading session with 8 energy band numbers. The results are shown in Table 122.

Table 122: Mean Energy Band Values for 8 bands & 0 – 2000 Hz

	FEMALE INTERVIEW			FEMALE READING		
	Suicidal Mean	Depressed Mean	Remitted Mean	Suicidal Mean	Depressed Mean	Remitted Mean
PSD 1	0.622082404	0.594819312	0.535838526	0.552443702	0.565134122	0.514168276
PSD 2	0.254761875	0.249105506	0.271571163	0.311336022	0.273192586	0.291966521
PSD 3	0.067327054	0.097511477	0.11538469	0.087673866	0.10609166	0.122857092
PSD 4	0.0200657	0.028338133	0.033525376	0.018425882	0.028884413	0.030894466
PSD 5	0.011916123	0.009737423	0.01397842	0.009567516	0.009109649	0.011394012
PSD 6	0.008082017	0.00626185	0.009323545	0.007223439	0.005725037	0.009362673
PSD 7	0.007730327	0.007317384	0.011541972	0.006561972	0.005583367	0.009971764
PSD 8	0.0080345	0.006908915	0.008836308	0.0067676	0.006279166	0.009385196
	MALE INTERVIEW			MALE READING		
	Suicidal Mean	Depressed Mean	Remitted Mean	Suicidal Mean	Depressed Mean	Remitted Mean
PSD 1	0.626271554	0.569917151	0.533256484	0.591525907	0.551602054	0.489006436
PSD 2	0.227135816	0.25734003	0.266358444	0.254007643	0.28943648	0.311679715
PSD 3	0.104476407	0.102877824	0.132681086	0.108981408	0.097651777	0.136277091
PSD 4	0.020700098	0.02183306	0.027302937	0.01912021	0.01824317	0.023489827
PSD 5	0.006994825	0.015678041	0.011008448	0.008360035	0.012385299	0.0099822
PSD 6	0.005574397	0.012796174	0.009524508	0.006449524	0.009728365	0.009096543
PSD 7	0.004970646	0.011093749	0.010132876	0.006700334	0.010633988	0.01022107
PSD 8	0.003876256	0.008463972	0.009735217	0.004854938	0.010318868	0.010247117

The table below shows the t-Test results. For the female DP-HR pairwise group during the interview session, PSD 3, PSD 4, PSD 5, and PSD 6 are statistically significant features. All energy bands except PSD 3 and PSD 4 are statistically significant features for the male DP-HR pairwise group during the interview session. All eight energy bands are the statistically significant features for the female DP-RM pairwise group during the interview session and for the male HR-RM pairwise group during the interview session. All eight energy bands except PSD 2 and PSD 7 are the statistically significant features for the male DP-RM pairwise group during the interview session. PSD 1, PSD 3, PSD 4, and PSD 7 are statistically significant features for the female HR-RM pairwise group during the interview session.

For the female DP-HR pairwise group during the reading session, PSD 2, PSD 3 and PSD 4 are statistically significant features. All eight energy bands except PSD 3 and

PSD 4 are statistically significant features for the male DP-HR pairwise group during the reading session. PSD 1, PSD 5, PSD 6, PSD 7 and PSD 8 are statistically significant features for the female DP-RM pairwise group during the reading session. PSD 1, PSD 3, PSD 4, and PSD 5 are statistically significant features for the male DP-RM pairwise group during the reading session. PSD 3, PSD 4, and PSD 7 are statistically significant features for the female HR-RM pairwise group during the reading session. All eight energy bands except PSD 4 and PSD 5 are statistically significant features for the male HR-RM pairwise group during the reading session. All of the results are shown in Table 123 and the statistically significant features are highlighted in yellow.

Table 123: Comparison of Significance Results for 8 bands & 0 – 2000 Hz

DP - HR FEMALE INTERVIEW			DP - HR MALE INTERVIEW			DP - HR FEMALE READING			DP - HR MALE READING		
	h	Significance		h	Significance		h	Significance		h	Significance
PSD 1	0	0.0734	PSD 1	1	3.51E-08	PSD 1	0	0.4953	PSD 1	1	0.0375
PSD 2	0	0.4902	PSD 2	1	2.84E-07	PSD 2	1	0.0012	PSD 2	1	0.0109
PSD 3	1	2.52E-07	PSD 3	0	0.6972	PSD 3	1	0.0113	PSD 3	0	0.1274
PSD 4	1	2.32E-06	PSD 4	0	0.583	PSD 4	1	1.83E-04	PSD 4	0	0.7049
PSD 5	1	0.0136	PSD 5	1	0	PSD 5	0	0.7023	PSD 5	1	2.00E-04
PSD 6	1	0.0051	PSD 6	1	0	PSD 6	0	0.1181	PSD 6	1	7.80E-05
PSD 7	0	0.6573	PSD 7	1	0	PSD 7	0	0.2823	PSD 7	1	4.41E-04
PSD 8	0	0.1716	PSD 8	1	0	PSD 8	0	0.7256	PSD 8	1	3.15E-05
DP - RM FEMALE INTERVIEW			DP - RM MALE INTERVIEW			DP - RM FEMALE READING			DP - RM MALE READING		
	h	Significance		h	Significance		h	Significance		h	Significance
PSD 1	1	4.33E-05	PSD 1	1	0.0039	PSD 1	1	0.0135	PSD 1	1	0.0029
PSD 2	1	0.002	PSD 2	0	0.3104	PSD 2	0	0.1113	PSD 2	0	0.1245
PSD 3	1	0.0021	PSD 3	1	4.72E-10	PSD 3	0	0.0522	PSD 3	1	1.80E-05
PSD 4	1	0.0033	PSD 4	1	2.05E-05	PSD 4	0	0.4897	PSD 4	1	0.0046
PSD 5	1	1.46E-08	PSD 5	1	9.81E-08	PSD 5	1	0.0474	PSD 5	1	0.0226
PSD 6	1	1.17E-09	PSD 6	1	9.72E-07	PSD 6	1	1.43E-04	PSD 6	0	0.4743
PSD 7	1	2.61E-05	PSD 7	0	0.1194	PSD 7	1	5.32E-05	PSD 7	0	0.7113
PSD 8	1	4.52E-04	PSD 8	1	0.0338	PSD 8	1	0.0081	PSD 8	0	0.9573
HR - RM FEMALE INTERVIEW			HR - RM MALE INTERVIEW			HR - RM FEMALE READING			HR - RM MALE READING		
	h	Significance		h	Significance		h	Significance		h	Significance
PSD 1	1	1.74E-06	PSD 1	1	1.42E-12	PSD 1	0	0.0956	PSD 1	1	2.60E-04
PSD 2	0	0.1074	PSD 2	1	6.08E-06	PSD 2	0	0.1458	PSD 2	1	9.37E-04
PSD 3	1	1.17E-12	PSD 3	1	3.74E-11	PSD 3	1	7.11E-05	PSD 3	1	0.0156
PSD 4	1	5.02E-10	PSD 4	1	0.0015	PSD 4	1	1.28E-06	PSD 4	0	0.1525
PSD 5	0	0.1123	PSD 5	1	6.01E-12	PSD 5	0	0.2142	PSD 5	0	0.0575
PSD 6	0	0.1515	PSD 6	1	0	PSD 6	0	0.0978	PSD 6	1	0.0013
PSD 7	1	0.0041	PSD 7	1	0	PSD 7	1	0.0152	PSD 7	1	0.001
PSD 8	0	0.4157	PSD 8	1	0	PSD 8	0	0.0817	PSD 8	1	1.28E-07

Table 124 shows the mean value shifts. The statistically significant features are highlighted in yellow and the red colored font indicates the features whose averages move in different directions for the female patients and the male patients. PSD 5 and PSD 6 in the DP-HR interview session, PSD 5 and the PSD 6 in the DP-RM interview session, PSD 2 in the DP-HR reading session; and PSD 5 in the DP-RM reading session are statistically significant features whose mean values move in different directions.

Table 124: Comparison of Sifts of Female and Male Patients for 8 bands & 0 – 2000 Hz

FEMALE The shift between Suicidal, Depressed (HR→ DP)				MALE The shift between Suicidal, Depressed (HR→ DP)			
	Interview			Reading			
PSD 1	0.0273	decrease	left	0.0127	increase	right	
PSD 2	0.0057	decrease	left	0.0381	decrease	left	
PSD 3	0.0302	increase	right	0.0184	increase	right	
PSD 4	0.0083	increase	right	0.0105	increase	right	
PSD 5	0.0022	decrease	left	0.0005	decrease	left	
PSD 6	0.0018	decrease	left	0.0015	decrease	left	
PSD 7	0.0004	decrease	left	0.001	decrease	left	
PSD 8	0.0011	decrease	left	0.0005	decrease	left	

FEMALE The shift between Depressed, Remitted (DP→ RM)				MALE The shift between Depressed, Remitted (DP→ RM)			
	Interview			Reading			
PSD 1	0.059	decrease	left	0.051	decrease	left	
PSD 2	0.0225	increase	right	0.0188	increase	right	
PSD 3	0.0179	increase	right	0.0168	increase	right	
PSD 4	0.0052	increase	right	0.002	increase	right	
PSD 5	0.0042	increase	right	0.0023	increase	right	
PSD 6	0.0031	increase	right	0.0036	increase	right	
PSD 7	0.0042	increase	right	0.0044	increase	right	
PSD 8	0.0019	increase	right	0.0031	increase	right	

FEMALE The shift between Suicidal, Remitted (HR→ RM)				MALE The shift between Suicidal, Remitted (HR→ RM)			
	Interview			Reading			
PSD 1	0.0862	decrease	left	0.0383	decrease	left	
PSD 2	0.0168	increase	right	0.0194	decrease	left	
PSD 3	0.0481	increase	right	0.0352	increase	right	
PSD 4	0.0135	increase	right	0.0125	increase	right	
PSD 5	0.0021	increase	right	0.0018	increase	right	
PSD 6	0.0012	increase	right	0.0021	increase	right	
PSD 7	0.0038	increase	right	0.0034	increase	right	
PSD 8	0.0008	increase	right	0.0026	increase	right	

Results of 9 Energy Bands in the 0 – 2000 Hz Frequency Range

Table 125 shows the mean values of nine energy bands in the 0-2000 Hz frequency range for all the patient groups. The mean values are calculated for the female patients and the male patients during the interview session and the reading session with 9 energy band numbers.

Table 125: Mean Energy Band Values for 9 bands & 0 – 2000 Hz

	FEMALE INTERVIEW			FEMALE READING		
	Suicidal Mean	Depressed Mean	Remitted Mean	Suicidal Mean	Depressed Mean	Remitted Mean
PSD 1	0.583235399	0.561285127	0.498131816	0.513339933	0.528279808	0.471562457
PSD 2	0.268685275	0.255472346	0.281009469	0.315926451	0.280361355	0.303445838
PSD 3	0.081610969	0.108702786	0.124623071	0.110325577	0.118908215	0.134345803
PSD 4	0.024162773	0.037169983	0.043092304	0.024287308	0.038907525	0.042373618
PSD 5	0.011933784	0.012304184	0.017166288	0.010261368	0.011542951	0.013454079
PSD 6	0.009234594	0.00628694	0.009076117	0.007297516	0.005862061	0.008497112
PSD 7	0.00664258	0.00584853	0.009434382	0.005932674	0.00480047	0.008666921
PSD 8	0.007270767	0.006784129	0.009677079	0.006007209	0.005604426	0.009147991
PSD 9	0.007223859	0.006145974	0.007789474	0.006621965	0.005733189	0.008506182
	MALE INTERVIEW			MALE READING		
	Suicidal Mean	Depressed Mean	Remitted Mean	Suicidal Mean	Depressed Mean	Remitted Mean
PSD 1	0.603251383	0.535622228	0.499101316	0.566116203	0.517900888	0.456844024
PSD 2	0.217608183	0.260166195	0.26203074	0.245496299	0.286620223	0.298950067
PSD 3	0.123656059	0.120777683	0.152412689	0.129863923	0.122086476	0.163106156
PSD 4	0.029703688	0.028398532	0.038596139	0.027592421	0.02403634	0.035079821
PSD 5	0.008024809	0.014993321	0.012714904	0.00893969	0.01229122	0.01049537
PSD 6	0.005518366	0.012644605	0.008602953	0.006109282	0.009619227	0.008443519
PSD 7	0.00483535	0.010875682	0.008924787	0.006337035	0.008919121	0.008737435
PSD 8	0.004153711	0.009342268	0.009339494	0.005433123	0.01003672	0.009179333
PSD 9	0.003248451	0.007179486	0.008276979	0.004112022	0.008489784	0.009164274

The table below (Table 126) shows the t-Test results. For the female DP-HR pairwise group during the interview session, PSD 3, PSD 4, and PSD 6 are statistically significant features. All energy bands except PSD 3 and PSD 4 are the statistically significant features for the male DP-HR pairwise group during the interview session. All nine energy bands are the statistically significant features for the female DP-RM pairwise

group during the interview session and for the male HR-RM pairwise group during the interview session. All nine energy bands except PSD 2 and PSD 8 are statistically significant features for the male DP-RM pairwise group during the interview session. All nine energy bands except PSD 2, PSD 6, and PSD 9 are statistically significant features for the female HR-RM pairwise group during the interview session.

For the female DP-HR pairwise group during the reading session, PSD 2 and PSD 4 are statistically significant features. All nine energy bands except PSD 3 and PSD 4 are statistically significant features for the male DP-HR pairwise group during the reading session. All nine energy bands except PSD 3, PSD 4, and PSD 5 are statistically significant features for the female DP-RM pairwise group during the reading session. PSD 1, PSD 3, and PSD 4 are statistically significant features for the male DP-RM pairwise group during the reading session. PSD 3, PSD 4, PSD 5, PSD 7 and PSD 8 are the statistically significant features for the female HR-RM pairwise group during the reading session. All nine energy bands except PSD 4 and PSD 5 are statistically significant features for the male HR-RM pairwise group during the reading session. All of the results are shown in Table 126 and the statistically significant features are highlighted in yellow.

Table 126: Comparison of Significance Results for 9 bands & 0 – 2000 Hz

DP - HR FEMALE INTERVIEW			DP - HR MALE INTERVIEW			DP - HR FEMALE READING			DP - HR MALE READING		
	h	Significance		h	Significance		h	Significance		h	Significance
PSD 1	0	0.1532	PSD 1	1	2.92E-10	PSD 1	0	0.4274	PSD 1	1	0.0167
PSD 2	0	0.0777	PSD 2	1	4.15E-12	PSD 2	1	0.0015	PSD 2	1	0.0021
PSD 3	1	2.99E-05	PSD 3	0	0.5048	PSD 3	0	0.2947	PSD 3	0	0.3319
PSD 4	1	1.15E-08	PSD 4	0	0.6022	PSD 4	1	2.71E-05	PSD 4	0	0.2581
PSD 5	0	0.6726	PSD 5	1	8.99E-15	PSD 5	0	0.3316	PSD 5	1	0.0017
PSD 6	1	9.56E-05	PSD 6	1	0	PSD 6	0	0.141	PSD 6	1	1.42E-05
PSD 7	0	0.2075	PSD 7	1	0	PSD 7	0	0.1381	PSD 7	1	0.0032
PSD 8	0	0.5085	PSD 8	1	0	PSD 8	0	0.6713	PSD 8	1	1.76E-05
PSD 9	0	0.1583	PSD 9	1	0	PSD 9	0	0.5216	PSD 9	1	4.57E-05
DP - RM FEMALE INTERVIEW			DP - RM MALE INTERVIEW			DP - RM FEMALE READING			DP - RM MALE READING		
	h	Significance		h	Significance		h	Significance		h	Significance
PSD 1	1	1.21E-05	PSD 1	1	0.0059	PSD 1	1	0.0057	PSD 1	1	0.0041
PSD 2	1	7.26E-05	PSD 2	0	0.8173	PSD 2	1	0.0348	PSD 2	0	0.3297
PSD 3	1	0.0131	PSD 3	1	1.02E-07	PSD 3	0	0.1109	PSD 3	1	6.70E-05
PSD 4	1	0.007	PSD 4	1	4.56E-10	PSD 4	0	0.3314	PSD 4	1	1.62E-04
PSD 5	1	2.95E-08	PSD 5	1	0.005	PSD 5	0	0.1387	PSD 5	0	0.061
PSD 6	1	7.11E-08	PSD 6	1	9.50E-09	PSD 6	1	0.0044	PSD 6	0	0.1818
PSD 7	1	1.52E-08	PSD 7	1	6.79E-04	PSD 7	1	7.88E-06	PSD 7	0	0.8362
PSD 8	1	1.73E-05	PSD 8	0	0.9962	PSD 8	1	7.38E-04	PSD 8	0	0.413
PSD 9	1	7.15E-04	PSD 9	1	0.023	PSD 9	1	0.0102	PSD 9	0	0.5638
HR - RM FEMALE INTERVIEW			HR - RM MALE INTERVIEW			HR - RM FEMALE READING			HR - RM MALE READING		
	h	Significance		h	Significance		h	Significance		h	Significance
PSD 1	1	3.61E-06	PSD 1	1	1.30E-14	PSD 1	0	0.0682	PSD 1	1	1.09E-04
PSD 2	0	0.21	PSD 2	1	1.19E-08	PSD 2	0	0.2863	PSD 2	1	3.82E-04
PSD 3	1	1.42E-08	PSD 3	1	8.03E-08	PSD 3	1	0.0211	PSD 3	1	0.0104
PSD 4	1	1.25E-14	PSD 4	1	5.71E-04	PSD 4	1	2.95E-09	PSD 4	0	0.0876
PSD 5	1	6.25E-05	PSD 5	1	5.34E-11	PSD 5	1	0.036	PSD 5	0	0.0694
PSD 6	0	0.8742	PSD 6	1	1.16E-11	PSD 6	0	0.3302	PSD 6	1	0.0015
PSD 7	1	0.002	PSD 7	1	0	PSD 7	1	0.0162	PSD 7	1	0.01
PSD 8	1	0.0123	PSD 8	1	0	PSD 8	1	0.0177	PSD 8	1	4.41E-06
PSD 9	0	0.5346	PSD 9	1	0	PSD 9	0	0.1938	PSD 9	1	8.79E-07

Table 127 shows the mean value shifts. The statistically significant features are highlighted in yellow and the red colored font indicates the features whose averages move in different directions for the female patients and the male patients. PSD 6 in the DP-HR interview session, PSD 5, PSD 6 and the PSD 7 in the DP-RM interview session, and PSD 2 in the DP-HR reading sessions are the statistically significant features whose mean values move in different directions.

Table 127: Comparison of Shifts of Female and Male Patients for 9 bands & 0 – 2000 Hz

FEMALE The shift between Suicidal, Depressed (HR--> DP)				MALE The shift between Suicidal, Depressed (HR--> DP)					
	Interview		Reading			Interview		Reading	
PSD 1	0.022	decrease left	0.0149	increase right	PSD 1	0.0676	decrease left	0.0482	decrease left
PSD 2	0.0132	decrease left	0.0356	decrease left	PSD 2	0.0426	increase right	0.0411	increase right
PSD 3	0.0271	increase right	0.0086	increase right	PSD 3	0.0029	decrease left	0.0078	decrease left
PSD 4	0.013	increase right	0.0146	increase right	PSD 4	0.0013	decrease left	0.0036	decrease left
PSD 5	0.0004	increase right	0.0013	increase right	PSD 5	0.007	increase right	0.0034	increase right
PSD 6	0.0029	decrease left	0.0014	decrease left	PSD 6	0.0071	increase right	0.0035	increase right
PSD 7	0.0008	decrease left	0.0011	decrease left	PSD 7	0.006	increase right	0.0026	increase right
PSD 8	0.0005	decrease left	0.0004	decrease left	PSD 8	0.0052	increase right	0.0046	increase right
PSD 9	0.0011	decrease left	0.0009	decrease left	PSD 9	0.0039	increase right	0.0044	increase right

FEMALE The shift between Depressed, Remitted (DP--> RM)				MALE The shift between Depressed, Remitted (DP--> RM)					
	Interview		Reading			Interview		Reading	
PSD 1	0.0632	decrease left	0.0567	decrease left	PSD 1	0.0365	decrease left	0.0611	decrease left
PSD 2	0.0255	increase right	0.0231	increase right	PSD 2	0.0019	increase right	0.0123	increase right
PSD 3	0.0159	increase right	0.0154	increase right	PSD 3	0.0316	increase right	0.041	increase right
PSD 4	0.0059	increase right	0.0035	increase right	PSD 4	0.0102	increase right	0.011	increase right
PSD 5	0.0049	increase right	0.0019	increase right	PSD 5	0.0023	decrease left	0.0018	decrease left
PSD 6	0.0028	increase right	0.0026	increase right	PSD 6	0.004	decrease left	0.0012	decrease left
PSD 7	0.0036	increase right	0.0039	increase right	PSD 7	0.002	decrease left	0.0002	decrease left
PSD 8	0.0029	increase right	0.0035	increase right	PSD 8	3E-06	decrease left	0.0009	decrease left
PSD 9	0.0016	increase right	0.0028	increase right	PSD 9	0.0011	increase right	0.0007	increase right

FEMALE The shift between Suicidal, Remitted (HR--> RM)				MALE The shift between Suicidal, Remitted (HR --> RM)					
	Interview		Reading			Interview		Reading	
PSD 1	0.0851	decrease left	0.0418	decrease left	PSD 1	0.1042	decrease left	0.1093	decrease left
PSD 2	0.0123	increase right	0.0125	decrease left	PSD 2	0.0444	increase right	0.0535	increase right
PSD 3	0.043	increase right	0.024	increase right	PSD 3	0.0288	increase right	0.0332	increase right
PSD 4	0.0189	increase right	0.0181	increase right	PSD 4	0.0089	increase right	0.0075	increase right
PSD 5	0.0052	increase right	0.0032	increase right	PSD 5	0.0047	increase right	0.0016	increase right
PSD 6	0.0002	decrease left	0.0012	increase right	PSD 6	0.0031	increase right	0.0023	increase right
PSD 7	0.0028	increase right	0.0027	increase right	PSD 7	0.0041	increase right	0.0024	increase right
PSD 8	0.0024	increase right	0.0031	increase right	PSD 8	0.0052	increase right	0.0037	increase right
PSD 9	0.0006	increase right	0.0019	increase right	PSD 9	0.005	increase right	0.0051	increase right

Results of 10 Energy Bands in the 0 – 2000 Hz Frequency Range

In this part of the research, the mean values of the 10 energy bands in the 0-2000 Hz frequency range for the entire patient groups are examined for the female patients and the male patients during the interview session and the reading session. Results are shown in Table 128.

Table 128: Mean Energy Band Values for 10 bands & 0 – 2000 Hz

	FEMALE INTERVIEW			FEMALE READING		
	Suicidal Mean	Depressed Mean	Remitted Mean	Suicidal Mean	Depressed Mean	Remitted Mean
PSD 1	0.523224077	0.509407765	0.441173952	0.455170252	0.470428104	0.407672151
PSD 2	0.28497646	0.261914614	0.293602496	0.314883777	0.288340437	0.318126171
PSD 3	0.107186423	0.124430666	0.132025034	0.146701741	0.136974748	0.145177368
PSD 4	0.034405413	0.054731824	0.06607987	0.0404327	0.05841231	0.068286797
PSD 5	0.01444466	0.019289558	0.023438401	0.012691002	0.019147182	0.020623868
PSD 6	0.009599992	0.008344975	0.011994671	0.007925608	0.007798664	0.009568682
PSD 7	0.007520544	0.00528192	0.007640725	0.00620504	0.004866345	0.007383776
PSD 8	0.005796187	0.005060381	0.008222193	0.005151503	0.004149604	0.007571511
PSD 9	0.006415112	0.006040907	0.008846669	0.005336886	0.004870515	0.008128008
PSD 10	0.006431132	0.00549739	0.006975988	0.00550149	0.005012091	0.007461669
	MALE INTERVIEW			MALE READING		
	Suicidal Mean	Depressed Mean	Remitted Mean	Suicidal Mean	Depressed Mean	Remitted Mean
PSD 1	0.566667941	0.48485969	0.445220329	0.526819789	0.468055136	0.408714449
PSD 2	0.20261901	0.262809762	0.258538518	0.228805336	0.277944416	0.276760698
PSD 3	0.144722872	0.138971921	0.170206484	0.1538627	0.155180626	0.1948194
PSD 4	0.051027782	0.050141742	0.067689073	0.051486289	0.043122897	0.065210553
PSD 5	0.01354627	0.015184949	0.017944547	0.012661055	0.012630406	0.014947969
PSD 6	0.005765267	0.012818967	0.009155308	0.006990566	0.010201525	0.008130968
PSD 7	0.004695871	0.010709573	0.007584012	0.005090353	0.008098319	0.007388906
PSD 8	0.00421294	0.009483075	0.007785527	0.00556116	0.007816178	0.007638051
PSD 9	0.003728792	0.008463205	0.008224797	0.004947976	0.008836579	0.008132078
PSD 10	0.003013254	0.006557117	0.007651405	0.003774775	0.008113919	0.008256926

The table below (Table 129) shows the t-Test results. For the female DP-HR pairwise group during the interview session, PSD 2, PSD 3, PSD 4, PSD 5, and PSD 7 are statistically significant features. All ten energy bands except PSD 3, PSD 4 and PSD 5 are statistically significant features for the male DP-HR pairwise group during the interview session. All ten energy bands except PSD 3 are statistically significant features for the female DP-RM pairwise group during the interview session. All ten energy bands except PSD 2 and PSD 9 are statistically significant features for the male DP-RM pairwise group during the interview session. All ten energy bands except PSD 2, PSD 7, PSD 8, PSD 9 and PSD 10 are statistically significant features for the female HR-RM

pairwise group during the interview session. All ten energy bands are statistically significant features for the male HR-RM pairwise group during the interview session.

Table 129: Comparison of Significance Results for 10 bands & 0 – 2000

DP - HR FEMALE INTERVIEW			DP - HR MALE INTERVIEW			DP - HR FEMALE READING			DP - HR MALE READING		
	h	Significance		h	Significance		h	Significance		h	Significance
PSD 1	0	0.3723	PSD 1	1	6.11E-13	PSD 1	0	0.4237	PSD 1	1	0.0059
PSD 2	1	0.0017	PSD 2	1	0	PSD 2	1	0.0196	PSD 2	1	1.14E-04
PSD 3	1	0.0143	PSD 3	0	0.1669	PSD 3	0	0.2989	PSD 3	0	0.8835
PSD 4	1	6.79E-10	PSD 4	0	0.7456	PSD 4	1	4.00E-05	PSD 4	0	0.0615
PSD 5	1	9.22E-05	PSD 5	0	0.257	PSD 5	1	9.83E-04	PSD 5	0	0.9847
PSD 6	0	0.0757	PSD 6	1	0	PSD 6	0	0.8976	PSD 6	1	4.50E-04
PSD 7	1	3.60E-04	PSD 7	1	0	PSD 7	0	0.1119	PSD 7	1	9.70E-06
PSD 8	0	0.1801	PSD 8	1	0	PSD 8	0	0.1339	PSD 8	1	0.004
PSD 9	0	0.5872	PSD 9	1	0	PSD 9	0	0.5682	PSD 9	1	3.42E-05
PSD 10	0	0.1689	PSD 10	1	0	PSD 10	0	0.6753	PSD 10	1	5.13E-05
DP - RM FEMALE INTERVIEW			DP - RM MALE INTERVIEW			DP - RM FEMALE READING			DP - RM MALE READING		
	h	Significance		h	Significance		h	Significance		h	Significance
PSD 1	1	1.92E-06	PSD 1	1	0.0043	PSD 1	1	0.002	PSD 1	1	0.0055
PSD 2	1	1.08E-07	PSD 2	0	0.561	PSD 2	1	0.0061	PSD 2	0	0.9105
PSD 3	0	0.2435	PSD 3	1	2.18E-05	PSD 3	0	0.4201	PSD 3	1	0.001
PSD 4	1	3.88E-04	PSD 4	1	3.57E-13	PSD 4	1	0.0384	PSD 4	1	1.14E-05
PSD 5	1	0.0011	PSD 5	1	0.0023	PSD 5	0	0.4721	PSD 5	1	0.0421
PSD 6	1	1.41E-08	PSD 6	1	3.74E-07	PSD 6	0	0.0624	PSD 6	1	0.0174
PSD 7	1	6.64E-08	PSD 7	1	9.76E-08	PSD 7	1	0.0015	PSD 7	0	0.3442
PSD 8	1	9.73E-09	PSD 8	1	8.08E-04	PSD 8	1	6.43E-06	PSD 8	0	0.8192
PSD 9	1	3.22E-05	PSD 9	0	0.6424	PSD 9	1	5.27E-04	PSD 9	0	0.4453
PSD 10	1	8.40E-04	PSD 10	1	0.0197	PSD 10	1	0.0101	PSD 10	0	0.8978
HR - RM FEMALE INTERVIEW			HR - RM MALE INTERVIEW			HR - RM FEMALE READING			HR - RM MALE READING		
	h	Significance		h	Significance		h	Significance		h	Significance
PSD 1	1	1.02E-05	PSD 1	1	0	PSD 1	1	0.0335	PSD 1	1	2.54E-05
PSD 2	0	0.3577	PSD 2	1	0	PSD 2	0	0.7653	PSD 2	1	6.18E-05
PSD 3	1	0.0014	PSD 3	1	1.69E-04	PSD 3	0	0.8962	PSD 3	1	0.006
PSD 4	1	0	PSD 4	1	3.72E-10	PSD 4	1	6.44E-10	PSD 4	1	0.032
PSD 5	1	3.91E-08	PSD 5	1	0.0024	PSD 5	1	2.94E-05	PSD 5	0	0.2483
PSD 6	1	0.0253	PSD 6	1	4.53E-12	PSD 6	0	0.1709	PSD 6	0	0.108
PSD 7	0	0.8831	PSD 7	1	8.78E-14	PSD 7	0	0.2754	PSD 7	1	3.45E-04
PSD 8	1	0.0021	PSD 8	1	0	PSD 8	1	0.0156	PSD 8	1	0.012
PSD 9	1	0.0089	PSD 9	1	0	PSD 9	1	0.0187	PSD 9	1	2.67E-05
PSD 10	0	0.5002	PSD 10	1	0	PSD 10	0	0.1103	PSD 10	1	2.77E-07

For the female DP-HR pairwise group during the reading session, PSD 2, PSD 4, and PSD 5 are statistically significant features. All ten energy bands except PSD 3, PSD 4, and PSD 5 are statistically significant features for the male DP-HR pairwise group during the reading session. All ten energy bands except PSD 3, PSD 5, and PSD 6 are

statistically significant features for the female DP-RM pairwise group during the reading session. PSD 1, PSD 3, PSD 4, PSD 5 and PSD 6 are statistically significant features for the male DP-RM pairwise group during the reading session. PSD 1, PSD 4, PSD 5, PSD 8 and PSD 9 are statistically significant features for the female HR-RM pairwise group during the reading session. All ten energy bands except PSD 5 and PSD 6 are statistically significant features for the male HR-RM pairwise group during the reading session. All of the results are shown in Table 129 above and statistically significant features are highlighted in yellow.

Table 130 shows the mean value shifts. The statistically significant features are highlighted in yellow and the red colored font indicates the features whose averages move in different directions for the female patients and the male patients. PSD 2 and PSD 7 in the DP-HR interview session, PSD 6, PSD 7 and the PSD 8 in the DP-RM interview session, and PSD 2 in the DP-HR reading session are statistically significant features whose mean values move in different directions.

Table 130: Comparison of Shifts of Female and Male Patients for 10 bands & 0 – 2000 Hz

FEMALE The shift between Suicidal, Depressed (HR→ DP)				MALE The shift between Suicidal, Depressed (HR→ DP)			
	Interview			Reading			
PSD 1	0.0138	decrease	left	0.0153	increase	right	
PSD 2	0.0231	decrease	left	0.0265	decrease	left	
PSD 3	0.0172	increase	right	0.0097	decrease	left	
PSD 4	0.0203	increase	right	0.018	increase	right	
PSD 5	0.0048	increase	right	0.0065	increase	right	
PSD 6	0.0013	decrease	left	0.0001	decrease	left	
PSD 7	0.0022	decrease	left	0.0013	decrease	left	
PSD 8	0.0007	decrease	left	0.001	decrease	left	
PSD 9	0.0004	decrease	left	0.0005	decrease	left	
PSD 10	0.0009	decrease	right	0.0005	decrease	left	

FEMALE The shift between Depressed, Remitted (DP→ RM)				MALE The shift between Depressed, Remitted (DP→ RM)			
	Interview			Reading			
PSD 1	0.0682	decrease	left	0.0628	decrease	left	
PSD 2	0.0317	increase	right	0.0298	increase	right	
PSD 3	0.0076	increase	right	0.0082	increase	right	
PSD 4	0.0113	increase	right	0.0099	increase	right	
PSD 5	0.0041	increase	right	0.0015	increase	right	
PSD 6	0.0036	increase	right	0.0018	increase	right	
PSD 7	0.0024	increase	right	0.0025	increase	right	
PSD 8	0.0032	increase	right	0.0034	increase	right	
PSD 9	0.0028	increase	right	0.0033	increase	right	
PSD 10	0.0015	increase	right	0.0024	increase	right	

FEMALE The shift between Suicidal, Remitted (HR→ RM)				MALE The shift between Suicidal, Remitted (HR→ RM)			
	Interview			Reading			
PSD 1	0.0821	decrease	left	0.0475	decrease	left	
PSD 2	0.0086	increase	right	0.0032	increase	right	
PSD 3	0.0248	increase	right	0.0015	decrease	left	
PSD 4	0.0317	increase	right	0.0279	increase	right	
PSD 5	0.009	increase	right	0.0079	increase	right	
PSD 6	0.0024	increase	right	0.0016	increase	right	
PSD 7	0.0001	increase	right	0.0012	increase	right	
PSD 8	0.0024	increase	right	0.0024	increase	right	
PSD 9	0.0024	increase	right	0.0028	increase	right	
PSD 10	0.0005	increase	right	0.002	increase	right	

Results for the 0 – 3000 Hz Band Range

Results of 2 Energy Bands in the 0 – 3000 Hz Frequency Range

The mean values of two energy bands in the 0-3000 Hz frequency range for all the female and male patient groups are calculated during the interview session and the reading session with 2 energy band numbers. The results are shown in Table 131.

Table 131: Mean Energy Band Values for 2 bands & 0 – 3000 Hz

FEMALE INTERVIEW				FEMALE READING		
	Suicidal Mean	Depressed Mean	Remitted Mean	Suicidal Mean	Depressed Mean	Remitted Mean
PSD 1	0.967255274	0.968121749	0.960448695	0.968226275	0.972302273	0.959489413
PSD 2	0.032744726	0.031878251	0.039551305	0.031773725	0.027697727	0.040510587
MALE INTERVIEW				MALE READING		
	Suicidal Mean	Depressed Mean	Remitted Mean	Suicidal Mean	Depressed Mean	Remitted Mean
PSD 1	0.980269571	0.954400371	0.951827188	0.976090052	0.955720661	0.949113696
PSD 2	0.019730429	0.045599629	0.048172812	0.023909948	0.044279339	0.050886304

The table below (Table 132) shows the t-Test results. For the male DP-HR pairwise group during both interview and reading session, PSD 1 and PSD 2 are statistically significant features. PSD 1 and PSD 2 are statistically significant features for the female DP-RM pairwise group during both interview and reading session. PSD 1 and PSD 2 are statistically significant features for the male HR-RM pairwise group during both interview and reading session. These results are shown in Table 132 and the statistically significant features are highlighted in yellow.

Table 132: Comparison of Significance Results for 2 bands & 0 – 3000 Hz

DP - HR	FEMALE INTERVIEW		MALE INTERVIEW		FEMALE READING		MALE READING				
	h	Significance	h	Significance	h	Significance	h	Significance			
PSD 1	0	0.7712	PSD 1	1	0.00E+00	PSD 1	0	0.3671	PSD 1	1	1.10E-07
PSD 2	0	7.71E-01	PSD 2	1	0.00E+00	PSD 2	0	0.3671	PSD 2	1	1.10E-07
DP - RM	FEMALE INTERVIEW		MALE INTERVIEW		FEMALE READING		MALE READING				
	h	Significance	h	Significance	h	Significance	h	Significance			
PSD 1	1	4.50E-04	PSD 1	0	0.2569	PSD 1	1	1.00E-03	PSD 1	0	0.1368
PSD 2	1	4.50E-04	PSD 2	0	0.2569	PSD 2	1	1.00E-03	PSD 2	0	0.1368
HR - RM	FEMALE INTERVIEW		MALE INTERVIEW		FEMALE READING		MALE READING				
	h	Significance	h	Significance	h	Significance	h	Significance			
PSD 1	0	5.60E-02	PSD 1	1	5.85E-52	PSD 1	0	1.19E-01	PSD 1	1	3.02E-09
PSD 2	0	5.60E-02	PSD 2	1	5.85E-52	PSD 2	0	1.19E-01	PSD 2	1	3.02E-09

Table 133 shows the mean value shifts. The statistically significant features are highlighted in yellow. There are no statistically significant features whose averages move in different directions for the female patients and the male patients. Therefore, there aren't any gender specific differences for 2 bands in the 0-3000 Hz frequency range.

Table 133: Comparison of Shifts of Female and Male Patients for 2 bands & 0 – 3000 Hz

FEMALE The shift between Suicidal, Depressed (HR--> DP)			MALE The shift between Suicidal, Depressed (HR--> DP)		
	Interview	Reading		Interview	Reading
PSD 1	0.0009 increase right	0.0041 increase right	PSD 1	0.0259 decrease left	0.0204 decrease left
PSD 2	0.0009 decrease left	0.0041 decrease left	PSD 2	0.0259 increase right	0.0204 increase right
FEMALE The shift between Depressed, Remitted (DP--> RM)			MALE The shift between Depressed, Remitted (DP--> RM)		
	Interview	Reading		Interview	Reading
PSD 1	0.0077 decrease left	0.0128 decrease left	PSD 1	0.0026 decrease left	0.0066 decrease left
PSD 2	0.0077 increase right	0.0128 increase right	PSD 2	0.0026 increase right	0.0066 increase right
FEMALE The shift between Suicidal, Remitted (HR--> RM)			MALE The shift between Suicidal, Remitted (HR--> RM)		
	Interview	Reading		Interview	Reading
PSD 1	0.0068 decrease left	0.0087 decrease left	PSD 1	0.0284 decrease left	0.027 decrease left
PSD 2	0.0068 increase right	0.0087 increase right	PSD 2	0.0284 increase right	0.027 increase right

Results of 3 Energy Bands in the 0 – 3000 Hz Frequency Range

Table 134 shows the mean values of three energy bands in the 0-3000 Hz frequency range for all the patient groups. Mean values are calculated for female patients and male patients during the interview session and the reading session with 3 energy band numbers.

Table 134: Mean Energy Band Values for 3 bands & 0 – 3000 Hz

FEMALE INTERVIEW				FEMALE READING			
	Suicidal Mean	Depressed Mean	Remitted Mean	Suicidal Mean	Depressed Mean	Remitted Mean	
PSD 1	0.948526177	0.952898046	0.938204258	0.952510257	0.958118077	0.939637535	
PSD 2	0.033041715	0.028670531	0.041393728	0.027889411	0.025473766	0.038006284	
PSD 3	0.018432108	0.018431422	0.020402014	0.019600332	0.016408158	0.022356181	
MALE INTERVIEW				MALE READING			
	Suicidal Mean	Depressed Mean	Remitted Mean	Suicidal Mean	Depressed Mean	Remitted Mean	
PSD 1	0.968058045	0.92739503	0.932358171	0.961611299	0.934810181	0.931303792	
PSD 2	0.020298631	0.044412479	0.037126041	0.02533615	0.039180913	0.03513673	
PSD 3	0.011643323	0.028192491	0.030515788	0.013052551	0.026008906	0.033559478	

Table 135 shows the t-Test results, and statistically significant features are highlighted in yellow. According to this test, all three energy bands are the statistically significant features for the male DP-HR pairwise group during the interview and reading sessions, for the female DP-RM pairwise group during the reading session, for the male HR-RM pairwise group during both the interview and the reading sessions. PSD 1 and PSD 2 are statistically significant features for the female DP-RM pairwise group during the interview session. PSD 2 is the statistically significant feature for the male DP-RM pairwise group during the interview session and for the female HR-RM pairwise group during both the interview and the reading sessions. PSD 3 is the statistically significant feature for the male DP-RM pairwise group during the reading session.

Table 135: Comparison of Significance Results for 3 bands & 0 – 3000 Hz

DP - HR FEMALE INTERVIEW			DP - HR MALE INTERVIEW			DP - HR FEMALE READING			DP - HR MALE READING		
	h	Significance		h	Significance		h	Significance		h	Significance
PSD 1	0	0.2989	PSD 1	1	0.00E+00	PSD 1	0	0.3574	PSD 1	1	1.86E-07
PSD 2	0	9.95E-02	PSD 2	1	0.00E+00	PSD 2	0	0.5001	PSD 2	1	4.83E-05
PSD 3	0	0.9997	PSD 3	1	0	PSD 3	0	0.2392	PSD 3	1	1.44E-07
DP - RM FEMALE INTERVIEW			DP - RM MALE INTERVIEW			DP - RM FEMALE READING			DP - RM MALE READING		
	h	Significance		h	Significance		h	Significance		h	Significance
PSD 1	1	2.10E-06	PSD 1	0	0.131	PSD 1	1	5.98E-04	PSD 1	0	0.533
PSD 2	1	3.26E-09	PSD 2	1	6.72E-04	PSD 2	1	3.99E-04	PSD 2	0	0.2267
PSD 3	0	1.09E-01	PSD 3	0	0.135	PSD 3	1	5.50E-03	PSD 3	1	0.0177
HR - RM FEMALE INTERVIEW			HR - RM MALE INTERVIEW			HR - RM FEMALE READING			HR - RM MALE READING		
	h	Significance		h	Significance		h	Significance		h	Significance
PSD 1	0	5.10E-02	PSD 1	1	0.00E+00	PSD 1	0	1.01E-01	PSD 1	1	5.98E-08
PSD 2	1	1.82E-02	PSD 2	1	0.00E+00	PSD 2	1	3.35E-02	PSD 2	1	5.91E-04
PSD 3	0	0.311	PSD 3	1	0	PSD 3	0	0.401	PSD 3	1	6.31E-10

Table 136 shows the mean value shifts. Statistically significant features are highlighted in yellow and the red colored font indicates the features whose averages move in different directions for the female patients and the male patients. PSD 2 in the

DP-RM interview session is the statistically significant feature whose mean values move in different directions.

Table 136: Comparison of Shifts of Female and Male Patients for 3 bands & 0 – 3000 Hz

FEMALE The shift between Suicidal, Depressed (HR--> DP)				MALE The shift between Suicidal, Depressed (HR--> DP)					
	Interview		Reading			Interview		Reading	
PSD 1	0.0044	increase right	0.0056	increase right	PSD 1	0.0407	decrease left	0.0268	decrease left
PSD 2	0.0044	decrease left	0.0024	decrease left	PSD 2	0.0241	increase right	0.0138	increase right
PSD 3	7E-07	decrease left	0.0032	decrease left	PSD 3	0.0165	increase right	0.013	increase right
FEMALE The shift between Depressed, Remitted (DP--> RM)				MALE The shift between Depressed, Remitted (DP--> RM)					
	Interview		Reading			Interview		Reading	
PSD 1	0.0147	decrease left	0.0185	decrease left	PSD 1	0.005	increase right	0.0035	decrease left
PSD 2	0.0127	increase right	0.0125	increase right	PSD 2	0.0073	decrease left	0.004	decrease left
PSD 3	0.002	increase right	0.0059	increase right	PSD 3	0.0023	increase right	0.0076	increase right
FEMALE The shift between Suicidal, Remitted (HR--> RM)				MALE The shift between Suicidal, Remitted (HR--> RM)					
	Interview		Reading			Interview		Reading	
PSD 1	0.0103	decrease left	0.0129	decrease left	PSD 1	0.0357	decrease left	0.0303	decrease left
PSD 2	0.0084	increase right	0.0101	increase right	PSD 2	0.0168	increase right	0.0098	increase right
PSD 3	0.002	increase right	0.0028	increase right	PSD 3	0.0189	increase right	0.0205	increase right

Results of 4 Energy Bands in the 0 – 3000 Hz Frequency Range

In this part of the research, the mean values of the 4 energy bands in the 0-3000 Hz frequency range for the entire patient groups are examined for the female patients and the male patients during the interview session and the reading session. These results are shown in Table 137.

Table 137: Mean Energy Band Values for 4 bands & 0 – 3000 Hz

	FEMALE INTERVIEW			FEMALE READING		
	Suicidal Mean	Depressed Mean	Remitted Mean	Suicidal Mean	Depressed Mean	Remitted Mean
PSD 1	0.929654922	0.926492534	0.906882437	0.935333631	0.931210008	0.911183059
PSD 2	0.037600352	0.041629215	0.053566258	0.032892644	0.041092264	0.048306354
PSD 3	0.02056834	0.018697152	0.02588878	0.018973567	0.01648162	0.025962336
PSD 4	0.012176386	0.013181099	0.013662525	0.012800157	0.011216107	0.014548251
	MALE INTERVIEW			MALE READING		
	Suicidal Mean	Depressed Mean	Remitted Mean	Suicidal Mean	Depressed Mean	Remitted Mean
PSD 1	0.948801758	0.906901623	0.907315114	0.943735897	0.917760258	0.910013432
PSD 2	0.031467813	0.047498747	0.044512074	0.032354155	0.037960403	0.039100264
PSD 3	0.010877219	0.024051249	0.024500799	0.014052688	0.02461791	0.023928497
PSD 4	0.00885321	0.02154838	0.023672014	0.00985726	0.019661429	0.026957807

The table below, Table 138, shows the t-Test results. All four energy bands are statistically significant features for the male DP-HR pairwise group during the interview session, for the male HR-RM pairwise group during both the interview and reading sessions. PSD 1, PSD 2, and PSD 3 are statistically significant features for the female DP-RM pairwise group during the interview session and for the female HR-RM pairwise group during the interview session.

For the female DP-HR pairwise group during the reading session, PSD 2 is the only statistically significant feature. PSD 1, PSD 3, and PSD 4 are the statistically significant features for the male DP-HR pairwise group during the reading session and for the female DP-RM pairwise group during the reading session. PSD 4 is the only statistically significant feature for the male DP-RM pairwise group during the reading session. PSD 1 and PSD 2 are statistically significant features for the female HR-RM pairwise group during the reading session. These results are shown in Table 138 and the statistically significant features are highlighted in yellow.

Table 138: Comparison of Significance Results for 4 bands & 0 – 3000 Hz

DP - HR FEMALE INTERVIEW			DP - HR MALE INTERVIEW			DP - HR FEMALE READING			DP - HR MALE READING		
	h	Significance		h	Significance		h	Significance		h	Significance
PSD 1	0	5.45E-01	PSD 1	1	0.00E+00	PSD 1	0	0.5896	PSD 1	1	3.00E-06
PSD 2	0	1.30E-01	PSD 2	1	4.48E-09	PSD 2	1	0.036	PSD 2	0	0.0505
PSD 3	0	0.3312	PSD 3	1	0	PSD 3	0	0.4077	PSD 3	1	1.75E-05
PSD 4	0	0.423	PSD 4	1	0.00E+00	PSD 4	0	0.3307	PSD 4	1	1.23E-06
DP - RM FEMALE INTERVIEW			DP - RM MALE INTERVIEW			DP - RM FEMALE READING			DP - RM MALE READING		
	h	Significance		h	Significance		h	Significance		h	Significance
PSD 1	1	6.60E-06	PSD 1	0	9.10E-01	PSD 1	1	0.0053	PSD 1	0	1.92E-01
PSD 2	1	2.90E-06	PSD 2	0	1.41E-01	PSD 2	0	0.0768	PSD 2	0	6.46E-01
PSD 3	1	1.45E-06	PSD 3	0	7.38E-01	PSD 3	1	3.33E-04	PSD 3	0	0.7755
PSD 4	0	5.98E-01	PSD 4	0	0.0903	PSD 4	1	2.01E-02	PSD 4	1	0.0073
HR - RM FEMALE INTERVIEW			HR - RM MALE INTERVIEW			HR - RM FEMALE READING			HR - RM MALE READING		
	h	Significance		h	Significance		h	Significance		h	Significance
PSD 1	1	6.89E-04	PSD 1	1	0.00E+00	PSD 1	1	1.21E-02	PSD 1	1	1.18E-07
PSD 2	1	7.38E-06	PSD 2	1	1.29E-07	PSD 2	1	6.53E-04	PSD 2	1	0.0316
PSD 3	1	0.0278	PSD 3	1	0.00E+00	PSD 3	0	0.0614	PSD 3	1	4.96E-06
PSD 4	0	2.41E-01	PSD 4	1	0.00E+00	PSD 4	0	3.84E-01	PSD 4	1	1.10E-09

Table 139 shows the mean value shifts. Statistically significant features are highlighted in yellow. There are no statistically significant features whose averages move in different directions for the female patients and the male patients. Therefore, there aren't any gender specific differences for 4 bands in the 0-3000 Hz frequency range.

Table 139: Comparison of Shifts of Female and Male Patients for 4 bands & 0 – 3000 Hz

FEMALE The shift between Suicidal, Depressed (HR→ DP)				MALE The shift between Suicidal, Depressed (HR→ DP)					
	Interview		Reading			Interview		Reading	
PSD 1	0.0032	decrease left	0.0041	decrease left	PSD 1	0.0419	decrease left	0.026	decrease left
PSD 2	0.004	increase right	0.0082	increase right	PSD 2	0.01603	increase right	0.006	increase right
PSD 3	0.0019	decrease left	0.0025	decrease left	PSD 3	0.01317	increase right	0.011	increase right
PSD 4	0.001	increase right	0.0016	decrease left	PSD 4	0.0127	increase right	0.01	increase right
FEMALE The shift between Depressed, Remitted (DP→ RM)				MALE The shift between Depressed, Remitted (DP → RM)					
	Interview		Reading			Interview		Reading	
PSD 1	0.0196	decrease left	0.02	decrease left	PSD 1	0.00041	increase right	0.008	decrease left
PSD 2	0.0119	increase right	0.0072	increase right	PSD 2	0.00299	decrease left	0.001	increase right
PSD 3	0.0072	increase right	0.0095	increase right	PSD 3	0.00045	increase right	7E-04	decrease left
PSD 4	0.0005	increase right	0.0033	increase right	PSD 4	0.00212	increase right	0.007	increase right
FEMALE The shift between Suicidal, Remitted (HR→ RM)				MALE The shift between Suicidal, Remitted (HR→ RM)					
	Interview		Reading			Interview		Reading	
PSD 1	0.0228	decrease left	0.0242	decrease left	PSD 1	0.04149	decrease left	0.034	decrease left
PSD 2	0.016	increase right	0.0154	increase right	PSD 2	0.01304	increase right	0.007	increase right
PSD 3	0.0053	increase right	0.007	increase right	PSD 3	0.01362	increase right	0.01	increase right
PSD 4	0.0015	increase right	0.0017	increase right	PSD 4	0.01482	increase right	0.017	increase right

Results of 5 Energy Bands in the 0 – 3000 Hz Frequency Range

Mean values of five energy bands in the 0-3000 Hz frequency range for all the patient groups are determined and shown in Table 140. This table shows the results for the female patients and the male patients during the interview session and the reading session with 5 energy band numbers.

Table 140: Mean Energy Band Values for 5 bands & 0 – 3000 Hz

	FEMALE INTERVIEW			FEMALE READING		
	Suicidal Mean	Depressed Mean	Remitted Mean	Suicidal Mean	Depressed Mean	Remitted Mean
PSD 1	0.900808298	0.880247233	0.85045259	0.900790523	0.881625686	0.852834346
PSD 2	0.05665235	0.080541371	0.098956092	0.059276623	0.083930075	0.095789841
PSD 3	0.018396731	0.015710174	0.023643094	0.015588168	0.013384172	0.021940919
PSD 4	0.014705462	0.012938146	0.016378319	0.014692424	0.012192718	0.01825735
PSD 5	0.009437158	0.010563075	0.010569905	0.009652262	0.00886735	0.011177544
	MALE INTERVIEW			MALE READING		
	Suicidal Mean	Depressed Mean	Remitted Mean	Suicidal Mean	Depressed Mean	Remitted Mean
PSD 1	0.904089363	0.863830212	0.849252218	0.898259941	0.880442516	0.85369731
PSD 2	0.069538267	0.075881442	0.091838703	0.070247905	0.064087467	0.085411019
PSD 3	0.012115439	0.026662737	0.02196991	0.01507108	0.022742854	0.020945222
PSD 4	0.007125554	0.016749978	0.017195937	0.008448564	0.017161428	0.017073503
PSD 5	0.007131376	0.016875631	0.019743232	0.00797251	0.015565735	0.022872946

The table below (Table 141) shows the t-Test results. For the female DP-HR pairwise group during the interview session, PSD 1 and PSD 2 are statistically significant features. PSD 1, PSD 3, PSD 4 and PSD 5 are statistically significant features for the male DP-HR pairwise group during the interview session. All five energy bands except PSD 5 are statistically significant features for the female DP-RM pairwise group during the interview session. All five energy bands except PSD 4 are statistically significant features for the male DP-RM pairwise group during the interview session. PSD 1, PSD 2, and PSD 3 are statistically significant features for the female HR-RM pairwise group

during the interview session. All five energy bands are statistically significant features for the male HR-RM pairwise group during the interview session.

Table 141: Comparison of Significance Results for 5 bands & 0 – 3000 Hz

DP - HR FEMALE INTERVIEW			DP - HR MALE INTERVIEW			DP - HR FEMALE READING			DP - HR MALE READING		
	h	Significance		h	Significance		h	Significance		h	Significance
PSD 1	1	0.0031	PSD 1	1	1.57E-13	PSD 1	0	0.0566	PSD 1	1	0.0167
PSD 2	1	7.02E-08	PSD 2	0	0.1356	PSD 2	1	9.42E-05	PSD 2	0	0.2862
PSD 3	0	0.094	PSD 3	1	0.00E+00	PSD 3	0	0.2692	PSD 3	1	1.60E-04
PSD 4	0	0.2086	PSD 4	1	0	PSD 4	0	0.3204	PSD 4	1	4.19E-07
PSD 5	0	0.2695	PSD 5	1	0	PSD 5	0	0.5282	PSD 5	1	3.69E-06
DP - RM FEMALE INTERVIEW			DP - RM MALE INTERVIEW			DP - RM FEMALE READING			DP - RM MALE READING		
	h	Significance		h	Significance		h	Significance		h	Significance
PSD 1	1	3.40E-06	PSD 1	1	1.20E-03	PSD 1	1	0.0049	PSD 1	1	2.00E-03
PSD 2	1	3.36E-05	PSD 2	1	7.49E-07	PSD 2	0	0.0774	PSD 2	1	3.03E-04
PSD 3	1	3.06E-08	PSD 3	1	4.92E-04	PSD 3	1	9.93E-05	PSD 3	0	0.3811
PSD 4	1	1.39E-04	PSD 4	0	6.44E-01	PSD 4	1	1.40E-03	PSD 4	0	0.96
PSD 5	0	9.93E-01	PSD 5	1	0.0057	PSD 5	1	0.0451	PSD 5	1	0.002
HR - RM FEMALE INTERVIEW			HR - RM MALE INTERVIEW			HR - RM FEMALE READING			HR - RM MALE READING		
	h	Significance		h	Significance		h	Significance		h	Significance
PSD 1	1	7.50E-09	PSD 1	1	0.00E+00	PSD 1	1	9.31E-05	PSD 1	1	1.94E-05
PSD 2	1	1.89E-15	PSD 2	1	5.88E-08	PSD 2	1	9.78E-09	PSD 2	0	0.0539
PSD 3	1	1.51E-02	PSD 3	1	0.00E+00	PSD 3	1	2.51E-02	PSD 3	1	0.0017
PSD 4	0	0.3219	PSD 4	1	0	PSD 4	0	0.2196	PSD 4	1	1.02E-07
PSD 5	0	0.2418	PSD 5	1	0	PSD 5	0	0.3142	PSD 5	1	2.62E-09

For the female DP-HR pairwise group during the reading session, PSD 2 is the only statistically significant feature. All five energy bands except PSD 2 are statistically significant features for the male DP-HR pairwise group during the reading session, for the female DP-RM pairwise group during the reading session, and for the male HR-RM pairwise group during the reading session. PSD 1, PSD 2, and PSD 5 are statistically significant features for the male DP-RM pairwise group during the reading session. PSD 1, PSD 2, and PSD 3 are statistically significant features for the female HR-RM pairwise group during the reading session. All of the results are shown in Table 141 above and statistically significant features are highlighted in yellow.

Table 142 shows the mean value shifts. The statistically significant features are highlighted in yellow and the red colored font indicates the features whose averages move in different directions for the female patients and the male patients. PSD 3 in the DP-RM interview session is the statistically significant features whose mean values move in different directions.

Table 142: Comparison of Shifts of Female and Male Patients for 5 bands & 0 – 3000 Hz

FEMALE The shift between Suicidal, Depressed (HR→ DP)				MALE The shift between Suicidal, Depressed (HR→ DP)			
	Interview			Reading			
PSD 1	0.0206	decrease	left	0.0192	decrease	left	
PSD 2	0.0239	increase	right	0.0247	increase	right	
PSD 3	0.0027	decrease	left	0.0022	decrease	left	
PSD 4	0.0018	decrease	left	0.0025	decrease	left	
PSD 5	0.0011	increase	right	0.0008	decrease	left	

FEMALE The shift between Depressed, Remitted (DP→ RM)				MALE The shift between Depressed, Remitted (DP→ RM)			
	Interview			Reading			
PSD 1	0.0298	decrease	left	0.0288	decrease	left	
PSD 2	0.0184	increase	right	0.0119	increase	right	
PSD 3	0.0079	increase	right	0.0086	increase	right	
PSD 4	0.0034	increase	right	0.0061	increase	right	
PSD 5	7E-06	increase	right	0.0023	increase	right	

FEMALE The shift between Suicidal, Remitted (HR→ RM)				MALE The shift between Suicidal, Remitted (HR→ RM)			
	Interview			Reading			
PSD 1	0.0504	decrease	left	0.048	decrease	left	
PSD 2	0.0423	increase	right	0.0365	increase	right	
PSD 3	0.0052	increase	right	0.0064	increase	right	
PSD 4	0.0017	increase	right	0.0036	increase	right	
PSD 5	0.0011	increase	right	0.0015	increase	right	

Results of 6 Energy Bands in the 0 – 3000 Hz Frequency Range

In this part of the research, the mean values of the 6 energy bands in the 0-3000 Hz frequency range for the entire patient groups are observed for female patients and male patients during the interview session and the reading session. The results are shown in Table 143.

Table 143: Mean Energy Band Values for 6 bands & 0 – 3000 Hz

	FEMALE INTERVIEW			FEMALE READING		
	Suicidal Mean	Depressed Mean	Remitted Mean	Suicidal Mean	Depressed Mean	Remitted Mean
PSD 1	0.862961347	0.829355587	0.792119128	0.848641041	0.82499463	0.789283315
PSD 2	0.085416903	0.123346976	0.145739447	0.103916276	0.132940057	0.150164957
PSD 3	0.018855829	0.01547553	0.022447731	0.015889747	0.014461656	0.019903474
PSD 4	0.014197824	0.013325794	0.019172026	0.011963145	0.011109254	0.018065366
PSD 5	0.010703077	0.009683217	0.01165729	0.011448333	0.009057496	0.013411697
PSD 6	0.00786502	0.008812896	0.008864379	0.008141458	0.007436907	0.009171191
	MALE INTERVIEW			MALE READING		
	Suicidal Mean	Depressed Mean	Remitted Mean	Suicidal Mean	Depressed Mean	Remitted Mean
PSD 1	0.844011513	0.805568686	0.776884136	0.834931302	0.821305513	0.776071531
PSD 2	0.123968496	0.121883595	0.155443352	0.126734867	0.113488411	0.155383772
PSD 3	0.012253511	0.027056317	0.019563703	0.014462519	0.020933975	0.017831598
PSD 4	0.008174071	0.017554532	0.017633981	0.010949182	0.01830433	0.017230526
PSD 5	0.005686099	0.014063853	0.013362485	0.006041954	0.013196514	0.013540793
PSD 6	0.00590631	0.013873017	0.017112343	0.006880176	0.012771256	0.019941779

The table below shows the t-Test results. For the female DP-HR pairwise group during the interview session, PSD 1, PSD 2, and PSD 3 are statistically significant features. All energy bands except PSD 2 are the statistically significant features for the male DP-HR pairwise group during the interview session. All energy bands except PSD 6 are the statistically significant features for the female DP-RM pairwise group during the interview session. PSD 1, PSD 2, PSD 3, and PSD 6 are statistically significant features for the male DP-RM pairwise group during the interview session. PSD 1, PSD 2, and PSD 4 are statistically significant features for the female HR-RM pairwise group during the interview session. All six energy bands are statistically significant features for the male HR-RM pairwise group during the interview session.

For the female DP-HR pairwise group during the reading session, PSD 2 is the only statistically significant feature. PSD 3, PSD 4, PSD 5, and PSD 6 are statistically significant features for the male DP-HR pairwise group during the reading session. All energy bands except PSD 2 and PSD 6 are statistically significant features for the female

DP-RM pairwise group during the reading session. PSD 1, PSD 2, and PSD 6 are statistically significant features for the male DP-RM pairwise group during the reading session. PSD 1, PSD 2, and PSD 4 are statistically significant features for the female HR-RM pairwise group during the reading session. All six energy bands are statistically significant features for the male HR-RM pairwise group during the reading session. All of the results are shown in Table 144 and the statistically significant features are highlighted in yellow.

Table 144: Comparison of Significance Results for 6 bands & 0 – 3000 Hz

DP - HR FEMALE INTERVIEW			DP - HR MALE INTERVIEW			DP - HR FEMALE READING			DP - HR MALE READING		
	h	Significance		h	Significance		h	Significance		h	Significance
PSD 1	1	3.66E-04	PSD 1	1	4.53E-09	PSD 1	0	0.0621	PSD 1	0	0.1759
PSD 2	1	5.42E-08	PSD 2	0	0.6981	PSD 2	1	0.0015	PSD 2	0	0.1256
PSD 3	1	1.48E-02	PSD 3	1	0	PSD 3	0	4.60E-01	PSD 3	1	1.08E-04
PSD 4	0	0.5334	PSD 4	1	0	PSD 4	0	0.645	PSD 4	1	1.30E-04
PSD 5	0	0.3182	PSD 5	1	0	PSD 5	0	0.1886	PSD 5	1	8.35E-08
PSD 6	0	0.2777	PSD 6	1	0	PSD 6	0	0.5024	PSD 6	1	1.81E-05
DP - RM FEMALE INTERVIEW			DP - RM MALE INTERVIEW			DP - RM FEMALE READING			DP - RM MALE READING		
	h	Significance		h	Significance		h	Significance		h	Significance
PSD 1	1	3.99E-05	PSD 1	1	7.48E-06	PSD 1	1	0.0117	PSD 1	1	3.01E-04
PSD 2	1	0.0012	PSD 2	1	1.19E-10	PSD 2	0	0.0957	PSD 2	1	1.64E-05
PSD 3	1	1.29E-09	PSD 3	1	3.79E-08	PSD 3	1	0.0052	PSD 3	0	6.65E-02
PSD 4	1	2.68E-06	PSD 4	0	9.38E-01	PSD 4	1	2.25E-04	PSD 4	0	0.561
PSD 5	1	2.60E-03	PSD 5	0	0.3911	PSD 5	1	1.00E-03	PSD 5	0	0.8095
PSD 6	0	9.37E-01	PSD 6	1	3.69E-04	PSD 6	0	0.0777	PSD 6	1	7.13E-04
HR - RM FEMALE INTERVIEW			HR - RM MALE INTERVIEW			HR - RM FEMALE READING			HR - RM MALE READING		
	h	Significance		h	Significance		h	Significance		h	Significance
PSD 1	1	6.53E-10	PSD 1	1	0.00E+00	PSD 1	1	1.58E-04	PSD 1	1	1.06E-04
PSD 2	1	4.80E-14	PSD 2	1	1.15E-09	PSD 2	1	4.16E-06	PSD 2	1	0.0228
PSD 3	0	6.74E-02	PSD 3	1	3.66E-15	PSD 3	0	1.06E-01	PSD 3	1	0.0209
PSD 4	1	0.0064	PSD 4	1	0.00E+00	PSD 4	1	0.0125	PSD 4	1	5.77E-05
PSD 5	0	0.4321	PSD 5	1	0	PSD 5	0	0.3745	PSD 5	1	2.00E-08
PSD 6	0	0.2174	PSD 6	1	0	PSD 6	0	0.4116	PSD 6	1	1.05E-08

Table 145 shows the mean value shifts. The statistically significant features are highlighted in yellow and the red colored font indicates the features whose averages move in different directions for the female patients and the male patients. PSD 3 in the

DP-HR interview session, PSD 3 in the DP-RM interview session are the statistically significant features whose mean values move in different directions.

Table 145: Comparison of Shifts of Female and Male Patients for 6 bands & 0 – 3000 Hz

FEMALE The shift between Suicidal, Depressed (HR→ DP)				MALE The shift between Suicidal, Depressed (HR→ DP)			
	Interview			Reading			
PSD 1	0.0336	decrease	left	0.0236	decrease	left	
PSD 2	0.0379	increase	right	0.029	increase	right	
PSD 3	0.0034	decrease	left	0.0014	decrease	left	
PSD 4	0.0009	decrease	left	0.0009	decrease	left	
PSD 5	0.001	decrease	left	0.0024	decrease	left	
PSD 6	0.0009	increase	right	0.0007	decrease	left	

FEMALE The shift between Depressed, Remitted (DP→ RM)				MALE The shift between Depressed, Remitted (DP→ RM)			
	Interview			Reading			
PSD 1	0.0372	decrease	left	0.0357	decrease	left	
PSD 2	0.0224	increase	right	0.0172	increase	right	
PSD 3	0.007	increase	right	0.0054	increase	right	
PSD 4	0.0058	increase	right	0.007	increase	right	
PSD 5	0.002	increase	right	0.0044	increase	right	
PSD 6	5E-05	increase	right	0.0017	increase	right	

FEMALE The shift between Suicidal, Remitted (HR→ RM)				MALE The shift between Suicidal, Remitted (HR→ RM)			
	Interview			Reading			
PSD 1	0.0708	decrease	left	0.0594	decrease	left	
PSD 2	0.0603	increase	right	0.0462	increase	right	
PSD 3	0.0036	increase	right	0.004	increase	right	
PSD 4	0.005	increase	right	0.0061	increase	right	
PSD 5	0.001	increase	right	0.002	increase	right	
PSD 6	0.001	increase	right	0.001	increase	right	

Results of 7 Energy Bands in the 0 – 3000 Hz Frequency Range

Table 146 shows the mean values of seven energy bands in the 0-3000 Hz frequency range for all the patient groups. The mean values are found for the female patients and the male patients during the interview session and the reading session with 7 energy band numbers.

Table 146: Mean Energy Band Values for 7 bands & 0 – 3000 Hz

	FEMALE INTERVIEW			FEMALE READING		
	Suicidal Mean	Depressed Mean	Remitted Mean	Suicidal Mean	Depressed Mean	Remitted Mean
PSD 1	0.818986185	0.782250606	0.74454972	0.787578598	0.773226368	0.736743356
PSD 2	0.120453583	0.15938892	0.179152373	0.157297396	0.174005122	0.191058013
PSD 3	0.021581531	0.021396076	0.02894953	0.017772758	0.02043352	0.023830183
PSD 4	0.01236062	0.01116812	0.017366562	0.010968808	0.009223679	0.015846305
PSD 5	0.011896943	0.010515093	0.013665608	0.010895857	0.009868565	0.014747987
PSD 6	0.007940336	0.007678488	0.008548286	0.008230926	0.006784251	0.009945382
PSD 7	0.006780802	0.007602696	0.007767923	0.007255656	0.006458495	0.007828774
	MALE INTERVIEW			MALE READING		
	Suicidal Mean	Depressed Mean	Remitted Mean	Suicidal Mean	Depressed Mean	Remitted Mean
PSD 1	0.786891822	0.752352733	0.712452386	0.774898673	0.758145895	0.699561414
PSD 2	0.173509204	0.165752764	0.209602134	0.179440626	0.168775926	0.223664661
PSD 3	0.015280939	0.026163736	0.022051877	0.01634089	0.021085869	0.018822835
PSD 4	0.008677814	0.019030596	0.015803892	0.011067976	0.015964424	0.015109716
PSD 5	0.005661961	0.012348436	0.013514012	0.007292331	0.013682476	0.013355021
PSD 6	0.005041949	0.012452898	0.011688029	0.005025414	0.011568262	0.011968036
PSD 7	0.004936311	0.011898836	0.01488767	0.00593409	0.010777148	0.017518317

Table 147 shows the t-Test results. For the female DP-HR pairwise group during the interview session, PSD 1 and PSD 2 are statistically significant features. All seven energy bands except PSD 2 are statistically significant features for the male DP-HR pairwise group during the interview session. All seven energy bands except PSD 6 and PSD 7 are the statistically significant features for the female DP-RM pairwise group during the interview session. All seven energy bands except PSD 5 and PSD 6 are statistically significant features for the male DP-RM pairwise group during the interview session. PSD 1, PSD 2, PSD 3, and PSD 4 are statistically significant features for the female HR-RM pairwise group during the interview session. All seven energy bands are statistically significant features for the male HR-RM pairwise group during the interview session.

For the female DP-HR pairwise group during the reading session, none of the energy bands are statistically significant features. All seven energy bands except PSD 1

and PSD 2 are statistically significant features for the male DP-HR pairwise group during the reading session. PSD 1, PSD 4, PSD 5 and PSD 6 are statistically significant features for the female DP-RM pairwise group during the reading session. PSD 1, PSD 2, and PSD 7 are statistically significant features for the male DP-RM pairwise group during the reading session. The first four energy bands (PSD 1, PSD 2, PSD 3 and PSD 4) are statistically significant features for the female HR-RM pairwise group during the reading session. All seven energy bands except PSD 3 are statistically significant features for the male HR-RM pairwise group during the reading session. All of the results are shown in Table 147 below and the statistically significant features are highlighted in yellow.

Table 147: Comparison of Significance Results for 7 bands & 0 – 3000 Hz

DP - HR FEMALE INTERVIEW			DP - HR MALE INTERVIEW			DP - HR FEMALE READING			DP - HR MALE READING		
	h	Significance		h	Significance		h	Significance		h	Significance
PSD 1	1	0.0015	PSD 1	1	2.55E-06	PSD 1	0	0.3286	PSD 1	0	0.1607
PSD 2	1	1.32E-05	PSD 2	0	0.1843	PSD 2	0	0.1305	PSD 2	0	0.3054
PSD 3	0	9.04E-01	PSD 3	1	2.60E-12	PSD 3	0	2.30E-01	PSD 3	1	0.0055
PSD 4	0	0.3089	PSD 4	1	0.00E+00	PSD 4	0	0.2073	PSD 4	1	9.61E-04
PSD 5	0	2.21E-01	PSD 5	1	0	PSD 5	0	0.6093	PSD 5	1	1.21E-05
PSD 6	0	0.731	PSD 6	1	0	PSD 6	0	0.2278	PSD 6	1	8.97E-08
PSD 7	0	0.2858	PSD 7	1	0	PSD 7	0	0.392	PSD 7	1	6.04E-05
DP - RM FEMALE INTERVIEW			DP - RM MALE INTERVIEW			DP - RM FEMALE READING			DP - RM MALE READING		
	h	Significance		h	Significance		h	Significance		h	Significance
PSD 1	1	6.89E-04	PSD 1	1	1.56E-06	PSD 1	1	0.0312	PSD 1	1	1.75E-04
PSD 2	1	0.0214	PSD 2	1	5.69E-10	PSD 2	0	0.1746	PSD 2	1	1.55E-05
PSD 3	1	1.93E-07	PSD 3	1	1.60E-03	PSD 3	0	0.1278	PSD 3	0	1.27E-01
PSD 4	1	1.21E-07	PSD 4	1	8.30E-04	PSD 4	1	2.96E-05	PSD 4	0	0.5651
PSD 5	1	3.28E-05	PSD 5	0	1.28E-01	PSD 5	1	0.0031	PSD 5	0	0.8192
PSD 6	0	8.39E-02	PSD 6	0	0.2907	PSD 6	1	1.20E-03	PSD 6	0	0.7619
PSD 7	0	7.78E-01	PSD 7	1	2.32E-04	PSD 7	0	0.1151	PSD 7	1	4.81E-04
HR - RM FEMALE INTERVIEW			HR - RM MALE INTERVIEW			HR - RM FEMALE READING			HR - RM MALE READING		
	h	Significance		h	Significance		h	Significance		h	Significance
PSD 1	1	4.64E-08	PSD 1	1	0.00E+00	PSD 1	1	0.0059	PSD 1	1	1.12E-04
PSD 2	1	3.12E-09	PSD 2	1	1.17E-07	PSD 2	1	0.0095	PSD 2	1	0.0074
PSD 3	1	7.35E-04	PSD 3	1	1.04E-07	PSD 3	1	1.76E-02	PSD 3	0	0.0927
PSD 4	1	2.30E-03	PSD 4	1	0.00E+00	PSD 4	1	0.0162	PSD 4	1	0.0063
PSD 5	0	0.1915	PSD 5	1	0.00E+00	PSD 5	0	0.0838	PSD 5	1	5.16E-07
PSD 6	0	0.4867	PSD 6	1	0	PSD 6	0	0.2732	PSD 6	1	4.71E-09
PSD 7	0	0.1663	PSD 7	1	0	PSD 7	0	0.6007	PSD 7	1	3.57E-08

Table 148: Comparison of Shifts of Female and Male Patients for 7 bands & 0 – 3000 Hz

FEMALE The shift between Suicidal, Depressed (HR→ DP)						MALE The shift between Suicidal, Depressed (HR→ DP)							
	Interview			Reading				Interview			Reading		
PSD 1	0.0367	decrease	left	0.0144	decrease	left	PSD 1	0.0345	decrease	left	0.0168	decrease	left
PSD 2	0.0389	increase	right	0.0167	increase	right	PSD 2	0.0078	decrease	left	0.0107	decrease	left
PSD 3	0.0002	decrease	left	0.0027	increase	right	PSD 3	0.0109	increase	right	0.0047	increase	right
PSD 4	0.0012	decrease	left	0.0017	decrease	left	PSD 4	0.0104	increase	right	0.0049	increase	right
PSD 5	0.0014	decrease	left	0.001	decrease	left	PSD 5	0.0067	increase	right	0.0064	increase	right
PSD 6	0.0003	decrease	left	0.0014	decrease	left	PSD 6	0.0074	increase	right	0.0065	increase	right
PSD 7	0.0008	increase	right	0.0008	decrease	left	PSD 7	0.007	increase	right	0.0048	increase	right

FEMALE The shift between Depressed, Remitted (DP→ RM)						MALE The shift between Depressed, Remitted (DP→ RM)							
	Interview			Reading				Interview			Reading		
PSD 1	0.0377	decrease	left	0.0365	decrease	left	PSD 1	0.0399	decrease	left	0.0586	decrease	left
PSD 2	0.0198	increase	right	0.0171	increase	right	PSD 2	0.0438	increase	right	0.0549	increase	right
PSD 3	0.0076	increase	right	0.0034	increase	right	PSD 3	0.0041	decrease	left	0.0023	decrease	left
PSD 4	0.0062	increase	right	0.0066	increase	right	PSD 4	0.0032	decrease	left	0.0009	decrease	left
PSD 5	0.0032	increase	right	0.0049	increase	right	PSD 5	0.0012	increase	right	0.0003	decrease	left
PSD 6	0.0009	increase	right	0.0032	increase	right	PSD 6	0.0008	decrease	left	0.0004	increase	right
PSD 7	0.0002	increase	right	0.0014	increase	right	PSD 7	0.003	increase	right	0.0067	increase	right

FEMALE The shift between Suicidal, Remitted (HR→ RM)						MALE The shift between Suicidal, Remitted (HR→ RM)							
	Interview			Reading				Interview			Reading		
PSD 1	0.0744	decrease	left	0.0508	decrease	left	PSD 1	0.0744	decrease	left	0.0753	decrease	left
PSD 2	0.0587	increase	right	0.0338	increase	right	PSD 2	0.0361	increase	right	0.0442	increase	right
PSD 3	0.0074	increase	right	0.0061	increase	right	PSD 3	0.0068	increase	right	0.0025	increase	right
PSD 4	0.005	increase	right	0.0049	increase	right	PSD 4	0.0071	increase	right	0.004	increase	right
PSD 5	0.0018	increase	right	0.0039	increase	right	PSD 5	0.0079	increase	right	0.0061	increase	right
PSD 6	0.0006	increase	right	0.0017	increase	right	PSD 6	0.0066	increase	right	0.0069	increase	right
PSD 7	0.001	increase	right	0.0006	increase	right	PSD 7	0.01	increase	right	0.0116	increase	right

Table 148 above shows the mean value shifts. The statistically significant features are highlighted in yellow and the red colored font indicates the features whose averages move in different directions for the female patients and the male patients. PSD 3 and PSD 4 in the DP-RM interview session are statistically significant features whose mean values move in different directions.

Results of 8 Energy Bands in the 0 – 3000 Hz Frequency Range

The mean values of eight energy bands in the 0-3000 Hz frequency range for all the patient groups are calculated. This step is completed for the female patients and the

male patients during the interview session and the reading session with 8 energy band numbers. The results are shown in Table 149.

Table 149: Mean Energy Band Values for 8 bands & 0 – 3000 Hz

FEMALE INTERVIEW				FEMALE READING		
	Suicidal Mean	Depressed Mean	Remitted Mean	Suicidal Mean	Depressed Mean	Remitted Mean
PSD 1	0.777434956	0.739472886	0.701815166	0.732795364	0.726109208	0.690223039
PSD 2	0.152219965	0.187019648	0.20506727	0.202538268	0.2051008	0.220960021
PSD 3	0.024640145	0.031985044	0.039327715	0.02209726	0.032120758	0.034659303
PSD 4	0.012960207	0.009644171	0.014238543	0.010795385	0.008971506	0.013647051
PSD 5	0.010860548	0.010384539	0.015232476	0.009010869	0.008411617	0.013914424
PSD 6	0.009707792	0.008312613	0.010656304	0.009962698	0.008070003	0.012047913
PSD 7	0.006170611	0.00647096	0.006635414	0.006026399	0.005474768	0.007634762
PSD 8	0.006005775	0.006710139	0.007027111	0.006773758	0.005741339	0.006913489
MALE INTERVIEW				MALE READING		
	Suicidal Mean	Depressed Mean	Remitted Mean	Suicidal Mean	Depressed Mean	Remitted Mean
PSD 1	0.742573024	0.709212563	0.663784468	0.725092693	0.705922094	0.639068409
PSD 2	0.206228734	0.19768906	0.243530646	0.218643204	0.211838163	0.270945022
PSD 3	0.022966373	0.028401713	0.030913511	0.02235377	0.02338892	0.026218554
PSD 4	0.00850144	0.019097034	0.013598562	0.010000385	0.014571483	0.012881711
PSD 5	0.006525802	0.013892442	0.013822127	0.008687963	0.014459069	0.013318093
PSD 6	0.004351418	0.010158808	0.010678672	0.005364725	0.010158841	0.010610404
PSD 7	0.004678454	0.01095553	0.010989042	0.004544461	0.010352514	0.011839933
PSD 8	0.004174756	0.01059285	0.012682972	0.0053128	0.009308916	0.015117874

The table below (Table 150) shows the t-Test results. For the female DP-HR pairwise group during the interview session, PSD 1, PSD 2, PSD 3, and PSD 4 are statistically significant features. All energy bands except PSD 2 are statistically significant features for the male DP-HR pairwise group during the interview session. All eight energy bands except PSD 2, PSD 7, and PSD 8 are statistically significant features for the female DP-RM pairwise group during the interview session. PSD 1, PSD 2, PSD 4, and PSD 8 are statistically significant features for the male DP-RM pairwise group during the interview session. PSD 1, PSD 2, PSD 3, and PSD 5 are statistically

significant features for the female HR-RM pairwise group during the interview session. All eight energy bands are statistically significant features for the male HR-RM pairwise group during the interview session.

Table 150: Comparison of Significance Results for 8 bands & 0 – 3000 Hz

DP - HR FEMALE INTERVIEW			DP - HR MALE INTERVIEW			DP - HR FEMALE READING			DP - HR MALE READING		
	h	Significance		h	Significance		h	Significance		h	Significance
PSD 1	1	0.0038	PSD 1	1	3.16E-05	PSD 1	0	0.6813	PSD 1	0	0.1683
PSD 2	1	5.11E-04	PSD 2	0	1.50E-01	PSD 2	0	0.8362	PSD 2	0	0.5745
PSD 3	1	1.27E-04	PSD 3	1	0.0145	PSD 3	1	9.14E-04	PSD 3	0	0.6642
PSD 4	1	1.00E-03	PSD 4	1	0	PSD 4	0	1.86E-01	PSD 4	1	1.47E-04
PSD 5	0	0.6728	PSD 5	1	0	PSD 5	0	0.6558	PSD 5	1	1.41E-04
PSD 6	0	0.1375	PSD 6	1	0	PSD 6	0	0.2792	PSD 6	1	3.29E-06
PSD 7	0	0.6205	PSD 7	1	0	PSD 7	0	0.5122	PSD 7	1	2.53E-07
PSD 8	0	0.3094	PSD 8	1	0	PSD 8	0	0.2296	PSD 8	1	4.13E-04
DP - RM FEMALE INTERVIEW			DP - RM MALE INTERVIEW			DP - RM FEMALE READING			DP - RM MALE READING		
	h	Significance		h	Significance		h	Significance		h	Significance
PSD 1	1	2.40E-03	PSD 1	1	3.36E-06	PSD 1	0	0.0553	PSD 1	1	1.97E-04
PSD 2	0	0.0544	PSD 2	1	9.22E-08	PSD 2	0	0.249	PSD 2	1	7.98E-05
PSD 3	1	1.55E-04	PSD 3	0	8.76E-02	PSD 3	0	0.4123	PSD 3	0	1.30E-01
PSD 4	1	1.15E-09	PSD 4	1	5.22E-08	PSD 4	1	8.62E-04	PSD 4	0	0.1822
PSD 5	1	8.14E-06	PSD 5	0	9.32E-01	PSD 5	1	1.82E-04	PSD 5	0	0.4327
PSD 6	1	6.73E-05	PSD 6	0	3.93E-01	PSD 6	1	1.80E-03	PSD 6	0	0.6781
PSD 7	0	6.93E-01	PSD 7	0	0.9576	PSD 7	1	4.80E-03	PSD 7	0	0.2422
PSD 8	0	5.56E-01	PSD 8	1	0.0042	PSD 8	1	0.1411	PSD 8	1	0.001
HR - RM FEMALE INTERVIEW			HR - RM MALE INTERVIEW			HR - RM FEMALE READING			HR - RM MALE READING		
	h	Significance		h	Significance		h	Significance		h	Significance
PSD 1	1	4.22E-07	PSD 1	1	1.78E-15	PSD 1	1	0.0355	PSD 1	1	1.70E-04
PSD 2	1	1.36E-06	PSD 2	1	5.25E-06	PSD 2	0	0.2204	PSD 2	1	6.80E-03
PSD 3	1	4.56E-09	PSD 3	1	2.46E-04	PSD 3	1	2.04E-05	PSD 3	0	0.1818
PSD 4	0	3.47E-01	PSD 4	1	3.32E-14	PSD 4	0	1.15E-01	PSD 4	1	0.0097
PSD 5	1	0.0038	PSD 5	1	0.00E+00	PSD 5	1	0.009	PSD 5	1	1.41E-04
PSD 6	0	0.4008	PSD 6	1	0	PSD 6	0	0.2924	PSD 6	1	1.17E-06
PSD 7	0	0.4712	PSD 7	1	0	PSD 7	0	0.1522	PSD 7	1	6.90E-10
PSD 8	0	0.1178	PSD 8	1	0	PSD 8	0	0.8893	PSD 8	1	3.16E-07

For the female DP-HR pairwise group during the reading session, PSD 3 is the statistically significant features. All eight energy bands except PSD 1, PSD 2, and PSD 3 are statistically significant features for the male DP-HR pairwise group during the reading session and for the female DP-RM pairwise group during the reading session. PSD 1, PSD 2, and PSD 8 are statistically significant features for the male DP-RM pairwise group during the reading session. PSD 1, PSD 3, and PSD 5 are statistically

significant features for the female HR-RM pairwise group during the reading session. All eight energy bands except PSD 3 are statistically significant features for the male HR-RM pairwise group during the reading session. All of the results are shown in Table 150 above and statistically significant features are highlighted in yellow.

Table 151 shows the mean value shifts. The statistically significant features are highlighted in yellow and the red colored font indicates the features whose averages move in different directions for the female patients and the male patients. PSD 4 in the DP-HR interview session, and PSD 4 in the DP-RM interview session are statistically significant features whose mean values move in different directions.

Table 151: Comparison of Shifts of Female and Male Patients for 8 bands & 0 – 3000 Hz

FEMALE The shift between Suicidal, Depressed (HR--> DP)				MALE The shift between Suicidal, Depressed (HR--> DP)			
	Interview			Reading			
PSD 1	0.038	decrease	left	0.0067	decrease	left	
PSD 2	0.0348	increase	right	0.0026	increase	right	
PSD 3	0.0073	increase	right	0.01	increase	right	
PSD 4	0.0033	decrease	left	0.0018	decrease	left	
PSD 5	0.0005	decrease	left	0.0006	decrease	left	
PSD 6	0.0014	decrease	left	0.0019	decrease	left	
PSD 7	0.0003	increase	right	0.0006	decrease	left	
PSD 8	0.0007	increase	right	0.001	decrease	left	
FEMALE The shift between Depressed, Remitted (DP--> RM)				MALE The shift between Depressed, Remitted (DP--> RM)			
	Interview			Reading			
PSD 1	0.0377	decrease	left	0.0359	decrease	left	
PSD 2	0.018	increase	right	0.0159	increase	right	
PSD 3	0.0073	increase	right	0.0025	increase	right	
PSD 4	0.0046	increase	right	0.0047	increase	right	
PSD 5	0.0048	increase	right	0.0055	increase	right	
PSD 6	0.0023	increase	right	0.004	increase	right	
PSD 7	0.0002	increase	right	0.0022	increase	right	
PSD 8	0.0003	increase	right	0.0012	increase	right	
FEMALE The shift between Suicidal, Remitted (HR--> RM)				MALE The shift between Suicidal, Remitted (HR--> RM)			
	Interview			Reading			
PSD 1	0.0756	decrease	left	0.0426	decrease	left	
PSD 2	0.0528	increase	right	0.0184	increase	right	
PSD 3	0.0147	increase	right	0.0126	increase	right	
PSD 4	0.0013	increase	right	0.0029	increase	right	
PSD 5	0.0044	increase	right	0.0049	increase	right	
PSD 6	0.0009	increase	right	0.0021	increase	right	
PSD 7	0.0005	increase	right	0.0016	increase	right	
PSD 8	0.001	increase	right	0.0001	increase	right	

Results of 9 Energy Bands in the 0 – 3000 Hz Frequency Range

Table 152 shows the mean values of nine energy bands in the 0-3000 Hz frequency range for all the patient groups. The mean values are calculated for the female patients and the male patients during the interview session and the reading session with 9 energy band numbers.

Table 152: Mean Energy Band Values for 9 bands & 0 – 3000 Hz

	FEMALE INTERVIEW			FEMALE READING		
	Suicidal Mean	Depressed Mean	Remitted Mean	Suicidal Mean	Depressed Mean	Remitted Mean
PSD 1	0.737690489	0.698969551	0.657643552	0.682335072	0.681282493	0.644588152
PSD 2	0.180036031	0.208382375	0.22654102	0.239526124	0.229528278	0.243522499
PSD 3	0.030935257	0.045737079	0.054352649	0.030594522	0.047486068	0.051706459
PSD 4	0.013954575	0.011070076	0.015908451	0.011359507	0.010389329	0.013587462
PSD 5	0.009508127	0.008829902	0.013990144	0.008430847	0.007122589	0.012550905
PSD 6	0.009572407	0.008649379	0.011284453	0.008162091	0.007883304	0.011918314
PSD 7	0.007655349	0.006619746	0.008312796	0.008438829	0.006376146	0.009561977
PSD 8	0.005258034	0.005777447	0.005574504	0.00480592	0.004780957	0.006365078
PSD 9	0.005389731	0.005964444	0.006392431	0.006347088	0.005150836	0.006199155
	MALE INTERVIEW			MALE READING		
	Suicidal Mean	Depressed Mean	Remitted Mean	Suicidal Mean	Depressed Mean	Remitted Mean
PSD 1	0.706476899	0.670231529	0.624832888	0.683037076	0.660130058	0.590090381
PSD 2	0.225479652	0.22068101	0.260272377	0.244442465	0.243777771	0.298826041
PSD 3	0.036162347	0.036400124	0.047276216	0.034072873	0.030897613	0.042232876
PSD 4	0.008679487	0.019163594	0.013311403	0.010061746	0.014881957	0.012278708
PSD 5	0.006750048	0.014744285	0.012494557	0.008929082	0.012535174	0.011978508
PSD 6	0.004748923	0.010286912	0.011249677	0.006260304	0.01168552	0.010947116
PSD 7	0.003749863	0.009290425	0.009031169	0.004095387	0.008690365	0.008773444
PSD 8	0.00432724	0.009576297	0.010763833	0.004190976	0.009175871	0.011826537
PSD 9	0.003625541	0.009625824	0.010767881	0.004910091	0.008225672	0.013046389

The table below (Table 153) shows the t-Test results. For the female DP-HR pairwise group during the interview session, PSD 1, PSD 2, PSD 3, and PSD 4 are statistically significant features. All energy bands except PSD 2 and PSD 3 are statistically significant features for the male DP-HR pairwise group during the interview

session. All nine energy bands except PSD 2, PSD 8 and PSD 9 are statistically significant features for the female DP-RM pairwise group during the interview session. All nine energy bands except PSD 6, PSD 7, and PSD 9 are statistically significant features for the male DP-RM pairwise group during the interview session. PSD 1, PSD 2, PSD 3, and PSD 5 are statistically significant features for the female HR-RM pairwise group during the interview session. All nine energy bands are statistically significant features for the male HR-RM pairwise group during the interview session.

Table 153: Comparison of Significance Results for 9 bands & 0 – 3000 Hz

DP - HR FEMALE INTERVIEW			DP - HR MALE INTERVIEW			DP - HR FEMALE READING			DP - HR MALE READING		
	h	Significance		h	Significance		h	Significance		h	Significance
PSD 1	1	0.0068	PSD 1	1	3.09E-05	PSD 1	0	0.9527	PSD 1	0	0.1448
PSD 2	1	0.0064	PSD 2	0	4.18E-01	PSD 2	0	0.4607	PSD 2	0	0.9605
PSD 3	1	3.61E-08	PSD 3	0	0.9365	PSD 3	1	3.92E-05	PSD 3	0	0.3861
PSD 4	1	5.40E-03	PSD 4	1	0	PSD 4	0	4.88E-01	PSD 4	1	8.64E-05
PSD 5	0	0.4891	PSD 5	1	0.00E+00	PSD 5	0	0.2196	PSD 5	1	0.0033
PSD 6	0	3.11E-01	PSD 6	1	0	PSD 6	0	0.8538	PSD 6	1	2.68E-05
PSD 7	0	0.1543	PSD 7	1	0	PSD 7	0	0.1293	PSD 7	1	1.80E-07
PSD 8	0	0.3276	PSD 8	1	0	PSD 8	0	0.9697	PSD 8	1	4.58E-07
PSD 9	0	0.3591	PSD 9	1	0	PSD 9	0	0.1348	PSD 9	1	2.30E-03
DP - RM FEMALE INTERVIEW			DP - RM MALE INTERVIEW			DP - RM FEMALE READING			DP - RM MALE READING		
	h	Significance		h	Significance		h	Significance		h	Significance
PSD 1	1	2.10E-03	PSD 1	1	2.49E-05	PSD 1	0	0.0684	PSD 1	1	3.16E-04
PSD 2	0	5.77E-02	PSD 2	1	3.52E-05	PSD 2	0	0.3341	PSD 2	1	6.85E-04
PSD 3	1	0.0011	PSD 3	1	2.77E-08	PSD 3	0	0.3149	PSD 3	1	6.39E-04
PSD 4	1	1.10E-08	PSD 4	1	9.08E-09	PSD 4	1	0.02	PSD 4	1	3.59E-02
PSD 5	1	5.44E-07	PSD 5	1	0.0032	PSD 5	1	1.75E-05	PSD 5	0	0.6426
PSD 6	1	3.88E-05	PSD 6	0	1.50E-01	PSD 6	1	0.003	PSD 6	0	0.5505
PSD 7	1	2.34E-04	PSD 7	0	6.52E-01	PSD 7	1	7.61E-04	PSD 7	0	0.9288
PSD 8	0	5.88E-01	PSD 8	1	0.0396	PSD 8	1	1.53E-02	PSD 8	1	0.0274
PSD 9	0	3.86E-01	PSD 9	0	0.0876	PSD 9	0	0.1516	PSD 9	1	0.0027
HR - RM FEMALE INTERVIEW			HR - RM MALE INTERVIEW			HR - RM FEMALE READING			HR - RM MALE READING		
	h	Significance		h	Significance		h	Significance		h	Significance
PSD 1	1	6.14E-07	PSD 1	1	1.56E-13	PSD 1	0	0.0835	PSD 1	1	2.32E-04
PSD 2	1	4.78E-05	PSD 2	1	1.39E-04	PSD 2	0	0.8077	PSD 2	1	9.00E-03
PSD 3	1	1.74E-14	PSD 3	1	2.76E-04	PSD 3	1	9.42E-09	PSD 3	0	0.1031
PSD 4	0	1.87E-01	PSD 4	1	1.36E-11	PSD 4	0	2.01E-01	PSD 4	1	0.0305
PSD 5	1	1.30E-03	PSD 5	1	0.00E+00	PSD 5	1	0.0104	PSD 5	1	0.0144
PSD 6	0	0.1151	PSD 6	1	0.00E+00	PSD 6	1	0.0276	PSD 6	1	8.52E-07
PSD 7	0	0.4567	PSD 7	1	0	PSD 7	0	0.4939	PSD 7	1	7.48E-08
PSD 8	0	0.5455	PSD 8	1	0	PSD 8	0	0.0748	PSD 8	1	1.65E-10
PSD 9	0	0.0964	PSD 9	1	0	PSD 9	0	0.8742	PSD 9	1	2.37E-06

For the female DP-HR pairwise group during the reading session, PSD 3 is the only statistically significant feature. All nine energy bands except PSD 1, PSD 2 and PSD 3 are statistically significant features for the male DP-HR pairwise group during the reading session. All nine energy bands except PSD 1, PSD 2, PSD 3, and PSD 9 are statistically significant features for the female DP-RM pairwise group during the reading session. All nine energy bands except PSD 5, PSD 6, and PSD 7 are statistically significant features for the male DP-RM pairwise group during the reading session. PSD 3, PSD 5, and PSD 6 are statistically significant features for the female HR-RM pairwise group during the reading session. All nine energy bands except PSD 3 are statistically significant features for the male HR-RM pairwise group during the reading session. All of the results are shown in Table 153 above and statistically significant features are highlighted in yellow.

Table 154 shows the mean value shifts. The statistically significant features are highlighted in yellow and the red colored font indicates the features whose averages move in different directions for the female patients and the male patients. PSD 4 in the DP-HR interview session, PSD 4 and PSD 5 in the DP-RM interview session; and PSD 4 in the DP-RM reading session are statistically significant features whose mean values move in different directions.

Table 154: Comparison of Shifts of Female and Male Patients for 9 bands & 0 – 3000 Hz

FEMALE The shift between Suicidal, Depressed (HR--> DP)				MALE The shift between Suicidal, Depressed (HR--> DP)			
	Interview			Reading			
PSD 1	0.0387	decrease	left	0.0011	decrease	left	
PSD 2	0.0283	increase	right	0.01	decrease	left	
PSD 3	0.0148	increase	right	0.0169	increase	right	
PSD 4	0.0029	decrease	left	0.001	decrease	left	
PSD 5	0.0007	decrease	left	0.0013	decrease	left	
PSD 6	0.0009	decrease	left	0.0003	decrease	left	
PSD 7	0.001	decrease	left	0.0021	decrease	left	
PSD 8	0.0005	increase	right	2E-05	decrease	left	
PSD 9	0.0006	increase	right	0.0012	decrease	left	

FEMALE The shift between Depressed, Remitted (DP--> RM)				MALE The shift between Depressed, Remitted (DP--> RM)			
	Interview			Reading			
PSD 1	0.0413	decrease	left	0.0367	decrease	left	
PSD 2	0.0182	increase	right	0.014	increase	right	
PSD 3	0.0086	increase	right	0.0042	increase	right	
PSD 4	0.0048	increase	right	0.0032	increase	right	
PSD 5	0.0052	increase	right	0.0054	increase	right	
PSD 6	0.0026	increase	right	0.004	increase	right	
PSD 7	0.0017	increase	right	0.0032	increase	right	
PSD 8	0.0002	decrease	left	0.0016	increase	right	
PSD 9	0.0004	increase	right	0.001	increase	right	

FEMALE The shift between Suicidal, Remitted (HR--> RM)				MALE The shift between Suicidal, Remitted (HR--> RM)			
	Interview			Reading			
PSD 1	0.08	decrease	left	0.0377	decrease	left	
PSD 2	0.0465	increase	right	0.004	increase	right	
PSD 3	0.0234	increase	right	0.0211	increase	right	
PSD 4	0.002	increase	right	0.0022	increase	right	
PSD 5	0.0045	increase	right	0.0041	increase	right	
PSD 6	0.0017	increase	right	0.0038	increase	right	
PSD 7	0.0007	increase	right	0.0011	increase	right	
PSD 8	0.0003	increase	right	0.0016	increase	right	
PSD 9	0.001	increase	right	0.0001	decrease	left	

Results of 10 Energy Bands in the 0 – 3000 Hz Frequency Range

In this part of the research, the mean values of the 10 energy bands in the 0-3000 Hz frequency range for the entire patient groups are examined for the female patients and the male patients during the interview session and the reading session. The results are shown in Table 155.

Table 155: Mean Energy Band Values for 10 bands & 0 – 3000 Hz

	FEMALE INTERVIEW			FEMALE READING		
	Suicidal Mean	Depressed Mean	Remitted Mean	Suicidal Mean	Depressed Mean	Remitted Mean
PSD 1	0.690001395	0.653309857	0.604652427	0.625658709	0.630995377	0.589827535
PSD 2	0.210806903	0.226937376	0.245800163	0.275131814	0.250630308	0.26300681
PSD 3	0.041644649	0.065435452	0.078091049	0.046710988	0.069575853	0.079234105
PSD 4	0.015007702	0.015105919	0.020865043	0.012565635	0.014354221	0.016555737
PSD 5	0.00977343	0.007389489	0.010897623	0.008379918	0.006840583	0.01072756
PSD 6	0.008623301	0.008320685	0.012745471	0.00720825	0.006543589	0.01121336
PSD 7	0.008267065	0.007281222	0.009412305	0.00758251	0.006852662	0.010223406
PSD 8	0.006438398	0.005656925	0.006966014	0.007109913	0.005340056	0.008033944
PSD 9	0.004661758	0.005122314	0.004909638	0.004233617	0.004237817	0.005632651
PSD 10	0.0047754	0.005440761	0.005660267	0.005418644	0.004629533	0.005544893
	MALE INTERVIEW			MALE READING		
	Suicidal Mean	Depressed Mean	Remitted Mean	Suicidal Mean	Depressed Mean	Remitted Mean
PSD 1	0.669696777	0.625302775	0.583738159	0.640591315	0.61008182	0.540970916
PSD 2	0.234392586	0.238527437	0.265514059	0.257668625	0.270360696	0.312726394
PSD 3	0.059237187	0.057335825	0.076400786	0.058858678	0.048983482	0.072564657
PSD 4	0.01030108	0.018545617	0.015437917	0.011389227	0.015103985	0.012846362
PSD 5	0.006605889	0.014796943	0.01080027	0.007620843	0.011197917	0.010178572
PSD 6	0.00550955	0.011865794	0.011169641	0.007450238	0.011544937	0.01076665
PSD 7	0.003814736	0.008251031	0.009240829	0.004975261	0.009334512	0.009373549
PSD 8	0.003310818	0.008498947	0.007955108	0.003473303	0.007826916	0.007699954
PSD 9	0.003884599	0.008637846	0.00956394	0.003804806	0.008269503	0.010598017
PSD 10	0.003246778	0.008237785	0.010179291	0.004167704	0.007296232	0.012274929

The table below (Table 156) shows the t-Test results. For the female DP-HR pairwise group during the interview session, PSD 1, PSD 3, and PSD 5 are statistically significant features. All ten energy bands except PSD 2, PSD 3 are statistically significant features for the male DP-HR pairwise group during the interview session. All ten energy bands except PSD 9 and PSD 10 are statistically significant features for the female DP-RM pairwise group during the interview session. All ten energy bands except PSD 6, PSD 7, PSD 8 and PSD 9 are statistically significant features for the male DP-RM pairwise group during the interview session. PSD 1, PSD 2, PSD 3, PSD 4 and PSD 6 are statistically significant features for the female HR-RM pairwise group during the interview session. All ten energy bands are statistically significant features for the male HR-RM pairwise group during the interview session.

Table 156: Comparison of Significance Results for 10 bands & 0 – 3000 Hz

DP - HR FEMALE INTERVIEW			DP - HR MALE INTERVIEW			DP - HR FEMALE READING			DP - HR MALE READING		
	h	Significance		h	Significance		h	Significance		h	Significance
PSD 1	1	0.0155	PSD 1	1	2.52E-06	PSD 1	1	7.77E-01	PSD 1	0	0.0797
PSD 2	0	0.1055	PSD 2	0	0.4718	PSD 2	0	0.0717	PSD 2	0	3.68E-01
PSD 3	1	4.65E-10	PSD 3	0	0.5899	PSD 3	1	2.05E-05	PSD 3	0	0.0629
PSD 4	0	9.27E-01	PSD 4	1	1.45E-13	PSD 4	0	2.62E-01	PSD 4	1	0.0035
PSD 5	1	2.10E-03	PSD 5	1	0	PSD 5	0	1.57E-01	PSD 5	1	1.20E-04
PSD 6	0	0.7548	PSD 6	1	0	PSD 6	0	0.5067	PSD 6	1	6.14E-04
PSD 7	0	2.27E-01	PSD 7	1	0	PSD 7	0	0.6207	PSD 7	1	2.90E-05
PSD 8	0	0.203	PSD 8	1	0	PSD 8	0	0.1091	PSD 8	1	8.04E-08
PSD 9	0	0.3312	PSD 9	1	0	PSD 9	0	0.9943	PSD 9	1	1.30E-06
PSD 10	0	0.2484	PSD 10	1	0	PSD 10	0	0.2663	PSD 10	1	4.79E-04
DP - RM FEMALE INTERVIEW			DP - RM MALE INTERVIEW			DP - RM FEMALE READING			DP - RM MALE READING		
	h	Significance		h	Significance		h	Significance		h	Significance
PSD 1	1	6.42E-04	PSD 1	1	3.44E-04	PSD 1	0	0.0514	PSD 1	1	7.27E-04
PSD 2	1	3.73E-02	PSD 2	1	0.0058	PSD 2	0	0.3796	PSD 2	1	0.009
PSD 3	1	6.43E-04	PSD 3	1	8.18E-12	PSD 3	0	0.0906	PSD 3	1	1.99E-05
PSD 4	1	4.14E-08	PSD 4	1	1.60E-03	PSD 4	0	0.1653	PSD 4	1	4.54E-02
PSD 5	1	1.80E-09	PSD 5	1	3.01E-07	PSD 5	1	4.38E-04	PSD 5	0	0.3016
PSD 6	1	1.39E-05	PSD 6	0	2.97E-01	PSD 6	1	9.26E-05	PSD 6	0	0.4979
PSD 7	1	7.70E-05	PSD 7	0	6.05E-02	PSD 7	1	0.0044	PSD 7	0	0.9699
PSD 8	1	8.97E-04	PSD 8	0	3.08E-01	PSD 8	1	6.27E-04	PSD 8	0	0.881
PSD 9	0	5.25E-01	PSD 9	0	0.0738	PSD 9	1	1.70E-02	PSD 9	1	0.0353
PSD 10	0	6.27E-01	PSD 10	1	9.47E-04	PSD 10	0	0.1675	PSD 10	1	8.96E-04
HR - RM FEMALE INTERVIEW			HR - RM MALE INTERVIEW			HR - RM FEMALE READING			HR - RM MALE READING		
	h	Significance		h	Significance		h	Significance		h	Significance
PSD 1	1	6.91E-07	PSD 1	1	1.10E-12	PSD 1	0	0.1211	PSD 1	1	2.24E-04
PSD 2	1	0.0021	PSD 2	1	0.001	PSD 2	0	0.4573	PSD 2	1	7.30E-03
PSD 3	1	0	PSD 3	1	6.27E-07	PSD 3	1	2.17E-10	PSD 3	0	0.0632
PSD 4	1	2.04E-04	PSD 4	1	6.48E-09	PSD 4	1	2.81E-02	PSD 4	0	0.1539
PSD 5	0	2.74E-01	PSD 5	1	3.33E-15	PSD 5	0	1.03E-01	PSD 5	1	0.0039
PSD 6	1	0.0023	PSD 6	1	0.00E+00	PSD 6	1	0.008	PSD 6	1	0.0019
PSD 7	0	0.2396	PSD 7	1	0.00E+00	PSD 7	0	0.0934	PSD 7	1	9.94E-07
PSD 8	0	0.4799	PSD 8	1	0	PSD 8	0	0.5	PSD 8	1	2.74E-08
PSD 9	0	0.5949	PSD 9	1	0	PSD 9	0	0.0726	PSD 9	1	2.66E-10
PSD 10	0	0.0944	PSD 10	1	0.00E+00	PSD 10	0	0.8784	PSD 10	1	9.83E-07

For the female DP-HR pairwise group during the reading session, PSD 1 and PSD 3 are statistically significant features. All ten energy bands except PSD 1, PSD 2, and PSD 3 are statistically significant features for the male DP-HR pairwise group during the reading session. All ten energy bands except PSD 1, PSD 2, PSD 3, PSD 4 and PSD 10 are statistically significant features for the female DP-RM pairwise group during the reading session. All ten energy bands except PSD 5, PSD 6, PSD 7, and PSD 8 are statistically significant features for the male DP-RM pairwise group during the reading session. PSD 3, PSD 4, and PSD 6 are statistically significant features for the female HR-

RM pairwise group during the reading session. All ten energy bands except PSD 3 and PSD 4 are statistically significant features for the male HR-RM pairwise group during the reading session. All of the results are shown in Table 156 above and statistically significant features are highlighted in yellow.

Table 157: Comparison of Shifts of Female and Male Patients for 10 bands & 0 – 3000 Hz

FEMALE The shift between Suicidal, Depressed (HR→ DP)				MALE The shift between Suicidal, Depressed (HR→ DP)			
	Interview			Reading			
PSD 1	0.0367	decrease	left	0.0053	increase	right	
PSD 2	0.0161	increase	right	0.0245	decrease	left	
PSD 3	0.0238	increase	right	0.0229	increase	right	
PSD 4	1E-04	increase	right	0.0018	increase	right	
PSD 5	0.0024	decrease	left	0.0015	decrease	left	
PSD 6	0.0003	decrease	left	0.0007	decrease	left	
PSD 7	0.001	decrease	left	0.0007	decrease	left	
PSD 8	0.0008	decrease	left	0.0018	decrease	left	
PSD 9	0.0005	increase	right	4E-06	increase	right	
PSD 10	0.0007	increase	left	0.0008	decrease	left	

FEMALE The shift between Depressed, Remitted (DP→ RM)				MALE The shift between Depressed, Remitted (DP→ RM)			
	Interview			Reading			
PSD 1	0.0487	decrease	left	0.0412	decrease	left	
PSD 2	0.0189	increase	right	0.0124	increase	right	
PSD 3	0.0127	increase	right	0.0097	increase	right	
PSD 4	0.0058	increase	right	0.0022	increase	right	
PSD 5	0.0035	increase	right	0.0039	increase	right	
PSD 6	0.0044	increase	right	0.0047	increase	right	
PSD 7	0.0021	increase	right	0.0034	increase	right	
PSD 8	0.0013	increase	right	0.0027	increase	right	
PSD 9	0.0002	decrease	left	0.0014	increase	right	
PSD 10	0.0002	increase	right	0.0009	increase	right	

FEMALE The shift between Suicidal, Remitted (HR→ RM)				MALE The shift between Suicidal, Remitted (HR→ RM)			
	Interview			Reading			
PSD 1	0.0853	decrease	left	0.0358	decrease	left	
PSD 2	0.035	increase	right	0.0121	decrease	left	
PSD 3	0.0364	increase	right	0.0325	increase	right	
PSD 4	0.0059	increase	right	0.004	increase	right	
PSD 5	0.0011	increase	right	0.0023	increase	right	
PSD 6	0.0041	increase	right	0.004	increase	right	
PSD 7	0.0011	increase	right	0.0026	increase	right	
PSD 8	0.0005	increase	right	0.0009	increase	right	
PSD 9	0.0002	increase	right	0.0014	increase	right	
PSD 10	0.0009	increase	right	0.0001	increase	right	

Table 157 above shows the mean value shifts. The statistically significant features are highlighted in yellow and the red colored font indicates the features whose averages move in different directions for the female patients and the male patients. PSD 5 in the DP-HR interview session, PSD 4 and the PSD 5 in the DP-RM interview session are statistically significant features whose mean values move in different directions.

Results for the Exponential Band Edges

Exponential Band Edges in the 0 – 2000 Hz Frequency Range

In this part of the research, the mean values of the exponential band edges in the 0-2000 Hz frequency range for the entire patient groups are examined for the female patients and the male patients during the interview session and the reading session. The results are shown in Table 158.

Table 158: Mean Energy Band Values of Exponential Band Study for 0 – 2000 Hz

FEMALE INTERVIEW				FEMALE READING		
	Suicidal Mean	Depressed Mean	Remitted Mean	Suicidal Mean	Depressed Mean	Remitted Mean
PSD 1	0.603734772	0.578975616	0.51797241	0.533819175	0.5476975	0.493965292
PSD 2	0.267961861	0.258977641	0.283138889	0.322569293	0.284026621	0.305284458
PSD 3	0.092252357	0.131450553	0.154662421	0.113265268	0.141240773	0.160319011
PSD 4	0.036051009	0.030596189	0.044226281	0.030346264	0.027035105	0.040431239
MALE INTERVIEW				MALE READING		
	Suicidal Mean	Depressed Mean	Remitted Mean	Suicidal Mean	Depressed Mean	Remitted Mean
PSD 1	0.615286022	0.553692818	0.517320708	0.579410244	0.535649661	0.473909963
PSD 2	0.230597522	0.266585971	0.273630521	0.258397441	0.297388995	0.316814828
PSD 3	0.132453342	0.131288554	0.168316872	0.135602127	0.123616344	0.169574998
PSD 4	0.021663114	0.048432656	0.040731898	0.026590188	0.043345	0.039700212

The table below, Table 159, shows the t-Test results. PSD 3 is the statistically significant feature for the female DP-HR pairwise group during the interview session. PSD 1, PSD 2, and PSD 4 are statistically significant features for the male DP-HR pairwise group during the interview session. All four energy bands are statistically significant features for the female DP-RM pairwise group during the interview session and for the male HR-RM pairwise group during the interview session. PSD 1, PSD 3, and

PSD 4 are statistically significant features for the male DP-RM pairwise group during the interview session and for the female HR-RM pairwise group during the interview session.

For the female DP-HR pairwise group during the reading session, PSD 2 and PSD 3 are statistically significant features. PSD 1, PSD 2, and PSD 4 are statistically significant features for the male DP-HR pairwise group during the reading session. PSD 1 and PSD 4 are statistically significant features for the female DP-RM pairwise group during the reading session. PSD 1 and PSD 3 are statistically significant features for the male DP-RM pairwise group during the reading session. PSD 3 is the statistically significant feature for the female HR-RM pairwise group during the reading session. All four exponential edged energy bands are statistically significant features for the male HR-RM pairwise group during the reading session. These results are shown in Table 159 and statistically significant features are highlighted in yellow.

Table 159: Comparison of Significance Results of Exponential Band Study for 0 – 2000 Hz

DP - HR FEMALE INTERVIEW			DP - HR MALE INTERVIEW			DP - HR FEMALE READING			DP - HR MALE READING		
	h	Significance		h	Significance		h	Significance		h	Significance
PSD 1	0	1.05E-01	PSD 1	1	3.90E-09	PSD 1	0	0.4569	PSD 1	1	0.0261
PSD 2	0	2.68E-01	PSD 2	1	3.87E-09	PSD 2	1	0.0011	PSD 2	1	0.0056
PSD 3	1	1.54E-07	PSD 3	0	0.8334	PSD 3	1	0.0039	PSD 3	0	1.83E-01
PSD 4	0	0.0632	PSD 4	1	0.00E+00	PSD 4	0	0.4114	PSD 4	1	1.59E-05
DP - RM FEMALE INTERVIEW			DP - RM MALE INTERVIEW			DP - RM FEMALE READING			DP - RM MALE READING		
	h	Significance		h	Significance		h	Significance		h	Significance
PSD 1	1	2.35E-05	PSD 1	1	5.10E-03	PSD 1	1	0.0089	PSD 1	1	3.50E-03
PSD 2	1	6.52E-04	PSD 2	0	4.26E-01	PSD 2	0	0.0676	PSD 2	0	1.71E-01
PSD 3	1	1.70E-03	PSD 3	1	3.59E-11	PSD 3	0	8.59E-02	PSD 3	1	1.16E-05
PSD 4	1	5.58E-09	PSD 4	1	9.67E-04	PSD 4	1	5.15E-04	PSD 4	0	0.3538
HR - RM FEMALE INTERVIEW			HR - RM MALE INTERVIEW			HR - RM FEMALE READING			HR - RM MALE READING		
	h	Significance		h	Significance		h	Significance		h	Significance
PSD 1	1	2.45E-06	PSD 1	1	2.02E-13	PSD 1	0	8.19E-02	PSD 1	1	1.82E-04
PSD 2	0	1.46E-01	PSD 2	1	5.46E-07	PSD 2	0	1.81E-01	PSD 2	1	5.80E-04
PSD 3	1	3.58E-13	PSD 3	1	6.97E-11	PSD 3	1	1.86E-05	PSD 3	1	1.20E-02
PSD 4	1	3.81E-02	PSD 4	1	0.00E+00	PSD 4	0	5.91E-02	PSD 4	1	8.27E-05

Table 160 shows the mean value shifts. The statistically significant features are highlighted in yellow and the red colored font indicates the features whose averages move in different directions for the female patients and the male patients. PSD 4 in the DP-RM interview session, PSD 2 in the DP-HR reading session are statistically significant features whose mean values move in different directions for the exponential band edges study in the 0-2000 Hz frequency range.

Table 160: Comparison of Shifts of Female and Male Patients of Exponential Band Study for 0 – 2000 Hz

FEMALE The shift between Suicidal, Depressed (HR--> DP)				MALE The shift between Suicidal, Depressed (HR--> DP)			
	Interview			Reading			
PSD 1	0.0248	decrease	left	0.0139	increase	right	
PSD 2	0.009	decrease	left	0.0385	decrease	left	
PSD 3	0.0392	increase	right	0.028	increase	right	
PSD 4	0.0055	decrease	left	0.0033	decrease	left	

FEMALE The shift between Depressed, Remitted (DP--> RM)				MALE The shift between Depressed, Remitted (DP--> RM)			
	Interview			Reading			
PSD 1	0.061	decrease	left	0.0537	decrease	left	
PSD 2	0.0242	increase	right	0.0213	increase	right	
PSD 3	0.0232	increase	right	0.0191	increase	right	
PSD 4	0.0136	increase	right	0.0134	increase	right	

FEMALE The shift between Suicidal, Remitted (HR --> RM)				MALE The shift between Suicidal, Remitted (HR--> RM)			
	Interview			Reading			
PSD 1	0.0858	decrease	left	0.0399	decrease	left	
PSD 2	0.0152	increase	right	0.0173	decrease	left	
PSD 3	0.0624	increase	right	0.0471	increase	right	
PSD 4	0.0082	increase	right	0.0101	increase	right	

Exponential Band Edges in the 0 – 3000 Hz Frequency Range

In this part of the research, the mean values of the exponential band edges in the 0-3000 Hz frequency range for the entire patient groups are examined for the female

patients and the male patients during the interview session and the reading session. The results are shown in Table 161.

Table 161: Mean Energy Band Values of Exponential Band Study for 0 – 3000 Hz

FEMALE INTERVIEW				FEMALE READING		
	Suicidal Mean	Depressed Mean	Remitted Mean	Suicidal Mean	Depressed Mean	Remitted Mean
PSD 1	0.758992398	0.720502384	0.681638963	0.709180112	0.705026771	0.669128133
PSD 2	0.159104412	0.192658087	0.210685274	0.211977556	0.21142585	0.226969775
PSD 3	0.039337465	0.045013	0.05708949	0.034878924	0.044887965	0.051960382
PSD 4	0.032905621	0.031914019	0.039903528	0.031618885	0.027676828	0.040863032
MALE INTERVIEW				MALE READING		
	Suicidal Mean	Depressed Mean	Remitted Mean	Suicidal Mean	Depressed Mean	Remitted Mean
PSD 1	0.725043171	0.691577761	0.645213592	0.704947861	0.684403745	0.615503176
PSD 2	0.211878162	0.203955768	0.24902599	0.225978105	0.220321865	0.279288355
PSD 3	0.034235147	0.04930848	0.047857899	0.034650843	0.039582161	0.042209894
PSD 4	0.019878649	0.045703978	0.048266808	0.023998899	0.044455515	0.050829373

The table below, Table 162, shows the t-Test results. PSD1, PSD 2, and PSD 3 are statistically significant features for the female DP-HR pairwise group during the interview session and for the female HR-RM pairwise group during the interview session. PSD 1, PSD 3, and PSD 4 are statistically significant features for the male DP-HR pairwise group during the interview session and for the female DP-RM pairwise group during the interview session. PSD 1 and PSD 2 are statistically significant features for the male DP-RM pairwise group during the interview session. All four energy bands are the statistically significant features for the male HR-RM pairwise group during the interview session.

Table 162: Comparison of Significance Results of Exponential Band Study for 0 – 3000 Hz

DP - HR FEMALE INTERVIEW			DP - HR MALE INTERVIEW			DP - HR FEMALE READING			DP - HR MALE READING		
	h	Significance		h	Significance		h	Significance		h	Significance
PSD 1	1	5.00E-03	PSD 1	1	5.78E-05	PSD 1	0	0.8072	PSD 1	0	1.64E-01
PSD 2	1	9.68E-04	PSD 2	0	1.83E-01	PSD 2	0	0.9654	PSD 2	0	0.6505
PSD 3	1	0.0426	PSD 3	1	2.23E-07	PSD 3	1	0.0158	PSD 3	0	1.06E-01
PSD 4	0	0.7401	PSD 4	1	0.00E+00	PSD 4	0	0.3844	PSD 4	1	1.23E-07
DP - RM FEMALE INTERVIEW			DP - RM MALE INTERVIEW			DP - RM FEMALE READING			DP - RM MALE READING		
	h	Significance		h	Significance		h	Significance		h	Significance
PSD 1	1	2.60E-03	PSD 1	1	6.56E-06	PSD 1	0	0.0646	PSD 1	1	2.37E-04
PSD 2	0	5.74E-02	PSD 2	1	3.84E-07	PSD 2	0	0.2666	PSD 2	1	1.28E-04
PSD 3	1	7.35E-06	PSD 3	0	3.84E-07	PSD 3	0	9.97E-02	PSD 3	0	0.3179
PSD 4	1	2.85E-04	PSD 4	0	0.2608	PSD 4	1	8.13E-04	PSD 4	0	0.1522
HR - RM FEMALE INTERVIEW			HR - RM MALE INTERVIEW			HR - RM FEMALE READING			HR - RM MALE READING		
	h	Significance		h	Significance		h	Significance		h	Significance
PSD 1	1	5.68E-07	PSD 1	1	2.72E-14	PSD 1	0	5.67E-02	PSD 1	1	2.07E-04
PSD 2	1	3.50E-06	PSD 2	1	1.14E-05	PSD 2	0	3.32E-01	PSD 2	1	0.0072
PSD 3	1	1.25E-06	PSD 3	1	4.48E-07	PSD 3	1	2.41E-04	PSD 3	1	3.22E-02
PSD 4	0	5.13E-02	PSD 4	1	6.49E-51	PSD 4	0	1.03E-01	PSD 4	1	4.48E-09

For the female DP-HR pairwise group during the reading session and for the female HR-RM pairwise group during the reading session, PSD 3 is the only statistically significant feature. PSD 4 is the only statistically significant feature for the male DP-HR pairwise group during the reading session and for the female DP-RM pairwise group during the reading session. PSD 1 and PSD 2 are statistically significant features for the male DP-RM pairwise group during the reading session. All four exponential edged energy bands are statistically significant features for the male HR-RM pairwise group during the reading session. These results are shown in Table 162 above and statistically significant features are highlighted in yellow.

Table 163 below shows the mean value shifts. The statistically significant features are highlighted in yellow. There are no statistically significant features whose averages move in different directions for the female patients and the male patients. Therefore,

there aren't any gender specific differences for the exponential band edges study in the 0-3000 Hz frequency range.

Table 163: Comparison of Shifts of Female and Male Patients of Exponential Band Study for 0 – 3000 Hz

FEMALE The shift between Suicidal, Depressed (HR--> DP)			MALE The shift between Suicidal, Depressed (HR--> DP)		
	Interview	Reading		Interview	Reading
PSD 1	0.0385 decrease left	0.0042 decrease left	PSD 1	0.0335 decrease left	0.021 decrease left
PSD 2	0.0336 increase right	0.0006 decrease left	PSD 2	0.0079 decrease left	0.006 decrease left
PSD 3	0.0057 increase right	0.01 increase right	PSD 3	0.0151 increase right	0.005 increase right
PSD 4	0.001 decrease left	0.0039 decrease left	PSD 4	0.0258 increase right	0.02 increase right

FEMALE The shift between Depressed, Remitted (DP--> RM)			MALE The shift between Depressed, Remitted (DP--> RM)		
	Interview	Reading		Interview	Reading
PSD 1	0.0389 decrease left	0.0359 decrease left	PSD 1	0.0464 decrease left	0.069 decrease left
PSD 2	0.018 increase right	0.0155 increase right	PSD 2	0.0451 increase right	0.059 increase right
PSD 3	0.0121 increase right	0.0071 increase right	PSD 3	0.0015 decrease left	0.003 increase right
PSD 4	0.008 increase right	0.0132 increase right	PSD 4	0.0026 increase right	0.006 increase right

FEMALE The shift between Suicidal, Remitted (HR--> RM)			MALE The shift between Suicidal, Remitted (HR--> RM)		
	Interview	Reading		Interview	Reading
PSD 1	0.0774 decrease left	0.0401 decrease left	PSD 1	0.0798 decrease left	0.089 decrease left
PSD 2	0.0516 increase right	0.015 increase right	PSD 2	0.0371 increase right	0.053 increase right
PSD 3	0.0178 increase right	0.0171 increase right	PSD 3	0.0136 increase right	0.008 increase right
PSD 4	0.007 increase right	0.0092 increase right	PSD 4	0.0284 increase right	0.027 increase right

Results for the Non Uniform Band Edges

Non Uniform Band Edges in the 0 – 2000 Hz Frequency Range

For the non-uniform band edges study in the 0-2000 Hz frequency range, the band edge frequency range is swept in between 0 – 2000 Hz frequency range with 250 Hz frequency increment. Thirty five different combinations of non-uniform energy bands were used in the 0 – 2000 Hz frequency range. Table 68 shows the non-uniform band edges and 35 possible energy bands that are created with these edges.

In this part of the research, the mean values of the non-uniform band edges in the 0-2000 Hz frequency range for the entire patient groups are examined for the female

patients and the male patients during the interview session and the reading session. The results are shown in Table 164.

Table 164: Mean Energy Band Values of Non Uniform Band Edge Study for 0 – 2000 Hz

	FEMALE INTERVIEW		FEMALE READING	
	Suicidal Mean	Depressed Mean	Suicidal Mean	Depressed Mean
PSD 1	0.959333668	0.962006908	0.961478927	0.966712501
PSD 2	0.007760711	0.006079073	0.006902187	0.00561067
PSD 3	0.007147749	0.006945923	0.006071622	0.005305022
PSD 4	0.025757872	0.024968096	0.025547264	0.022371806
	MALE INTERVIEW		MALE READING	
	Suicidal Mean	Depressed Mean	Suicidal Mean	Depressed Mean
PSD 1	0.974679534	0.942139682	0.969736055	0.946373464
PSD 2	0.005441816	0.012156339	0.006265046	0.00917102
PSD 3	0.004755032	0.010254143	0.006489031	0.009584731
PSD 4	0.015123617	0.035449835	0.017509868	0.034870784

The table below, Table 165, shows the t-Test results. PSD 2 is the statistically significant feature for the female DP-HR pairwise group during the interview session. All four energy bands are statistically significant features for the male DP-HR pairwise group during the interview session. For the female DP-HR pairwise group during the reading session; none of the energy bands in the non-uniform band edges in the 0-2000 Hz frequency range is the statistically significant features. All four energy bands are statistically significant features for the male DP-HR pairwise group during the reading session. These results are shown in Table 165 and statistically significant features are highlighted in yellow.

Table 165: Comparison of Significance Results of Non Uniform Band Edge Study for 0 – 2000 Hz

DP - HR FEMALE INTERVIEW			DP - HR MALE INTERVIEW			DP - HR FEMALE READING			DP - HR MALE READING		
	h	Significance		h	Significance		h	Significance		h	Significance
PSD 1	0	4.48E-01	PSD 1	1	0.00E+00	PSD 1	0	0.3186	PSD 1	1	1.66E-07
PSD 2	1	6.30E-03	PSD 2	1	0.00E+00	PSD 2	0	0.1495	PSD 2	1	1.59E-04
PSD 3	0	8.17E-01	PSD 3	1	0	PSD 3	0	0.345	PSD 3	1	2.00E-03
PSD 4	0	7.45E-01	PSD 4	1	0.00E+00	PSD 4	0	0.411	PSD 4	1	2.80E-08

Table 166 shows the mean value shifts. The statistically significant features are highlighted in yellow and the red colored font indicates the features whose averages move in different directions for the female patients and the male patients. PSD 2 in the DP-HR interview session is the only statistically significant feature whose mean values move in different directions for the non-uniform band edges study in the 0-2000 Hz frequency range.

Table 166: Comparison of Shifts of Female and Male Patients of Non Uniform Band Edge Study for 0 – 2000 Hz

FEMALE	The shift between Suicidal, Depressed (HR--> DP)				MALE	The shift between Suicidal, Depressed (HR--> DP)							
	Interview		Reading			Interview		Reading					
PSD 1	0.0027	increase	right	0.0052	increase	right	PSD 1	0.0325	decrease	left	0.0234	decrease	left
PSD 2	0.0017	decrease	left	0.0013	decrease	left	PSD 2	0.0067	increase	right	0.0029	increase	right
PSD 3	0.0002	decrease	left	0.0008	decrease	left	PSD 3	0.0055	increase	right	0.0031	increase	right
PSD 4	0.0008	decrease	left	0.0032	decrease	left	PSD 4	0.0203	increase	right	0.0174	increase	right

Non Uniform Band Edges in the 0 – 3000 Hz Frequency Range

For the non-uniform band edges study in the 0-3000 Hz frequency range, the band edge frequency range is swept in between 0 – 3000 Hz frequency range with 250 Hz

frequency increment. One hundred and sixty five different combinations of non-uniform energy bands edges were used in the 0 – 3000 Hz frequency range. Table 73 shows the non-uniform band edges and the classification rates of 165 possible energy bands that are created with these edges.

In this part of the research, the mean values of the non-uniform band edges in the 0-3000 Hz frequency range for the entire patient groups are examined for the female patients and the male patients during the interview session and the reading session. The results are shown in Table 167.

Table 167: Mean Energy Band Values of Non Uniform Band Edge Study for 0 – 3000 Hz

	FEMALE INTERVIEW		FEMALE READING	
	Suicidal Mean	Depressed Mean	Suicidal Mean	Depressed Mean
PSD 1	0.987707381	0.986796268	0.987221861	0.988766374
PSD 2	0.00442258	0.004364959	0.004692879	0.003794278
PSD 3	0.003876972	0.004262603	0.00344253	0.003528008
PSD 4	0.003993067	0.004576171	0.00464273	0.003911341
	MALE INTERVIEW		MALE READING	
	Suicidal Mean	Depressed Mean	Suicidal Mean	Depressed Mean
PSD 1	0.991198549	0.978687307	0.990442708	0.980320878
PSD 2	0.002863336	0.00745259	0.002708275	0.006840983
PSD 3	0.003289578	0.007030637	0.003316163	0.00682743
PSD 4	0.002648537	0.006852028	0.003532854	0.00601071

The table below, Table 168, shows the t-Test results. None of the energy bands in the non-uniform band edges in the 0-3000 Hz frequency range is the statistically significant feature for the female DP-HR pairwise group during the interview session. All four energy bands are statistically significant features for the male DP-HR pairwise group during the interview session. For the female DP-HR pairwise group during the reading

session, none of the energy bands in the non-uniform band edges in the 0-3000 Hz frequency range is the statistically significant features. All four energy bands are statistically significant features for the male DP-HR pairwise group during the reading session. These results are shown in Table 168 and statistically significant features are highlighted in yellow.

Table 168: Comparison of Significance Results of Non Uniform Band Edge Study for 0 – 3000 Hz

DP - HR	FEMALE INTERVIEW		DP - HR	MALE INTERVIEW		DP - HR	FEMALE READING		DP - HR	MALE READING	
	h	Significance		h	Significance		h	Significance		h	Significance
PSD 1	0	4.71E-01	PSD 1	1	0.00E+00	PSD 1	0	0.355	PSD 1	1	3.54E-07
PSD 2	0	8.95E-01	PSD 2	1	0.00E+00	PSD 2	0	0.1876	PSD 2	1	8.80E-08
PSD 3	0	3.38E-01	PSD 3	1	0	PSD 3	0	0.8567	PSD 3	1	2.56E-06
PSD 4	0	2.39E-01	PSD 4	1	0.00E+00	PSD 4	0	0.2355	PSD 4	1	1.30E-03

Table 169 shows the mean value shifts. The statistically significant features are highlighted in yellow and the red colored font indicates the features whose averages move in different directions for the female patients and the male patients. None of the energy bands is the statistically significant feature whose mean values move in different directions for the non-uniform band edges study in the 0-3000 Hz frequency range.

Table 169: Comparison of Shifts of Female and Male Patients of Non Uniform Band Edge Study for 0 – 3000 Hz

FEMALE	The shift between Suicidal, Depressed (HR--> DP)						MALE	The shift between Suicidal, Depressed (HR--> DP)					
	Interview			Reading				Interview			Reading		
PSD 1	0.0009	decrease	left	0.0015	increase	right	PSD 1	0.0125	decrease	left	0.0101	decrease	left
PSD 2	6E-05	decrease	left	0.0009	decrease	left	PSD 2	0.0046	increase	right	0.0041	increase	right
PSD 3	0.0004	increase	right	9E-05	increase	right	PSD 3	0.0037	increase	right	0.0035	increase	right
PSD 4	0.0006	increase	right	0.0007	decrease	left	PSD 4	0.0042	increase	right	0.0025	increase	right

4 Performance Evaluation for the Gender Specific Differences on Optimized Energy Bands

The overall performance evaluation for the gender specific differences on optimized energy bands will be analyzed in this section. The gender specific differences are analyzed for all pairwise groups during the interview session and the reading session. Different band numbers (2, 3, 4, 5, 6, 7, 8, 9 and 10 bands) are analyzed in the 0-2000 Hz frequency range and statistically significant energy bands are found for each pairwise group during both sessions. The same band numbers are studied for the different band range of 0 - 3000 Hz, and statistically significant energy bands are also found for each pairwise group during both sessions for this frequency range of 0 -3000 Hz. Afterwards, the exponential edged energy bands in the 0-2000 Hz frequency range and in the 0-3000 Hz frequency range are studied and statistically significant energy bands are obtained. Finally, non-uniform edged energy bands in the 0-2000 Hz frequency range and in the 0-3000 Hz frequency range are studied and statistically significant energy bands are evaluated. Table 170 shows the results for all the pairwise groups during the interview session and Table 171 shows the results for all the pairwise groups during the reading session.

Table 170: Statistically Significant Energy Bands during the Interview Session

OPTIMIZATION TECHNIQUES	INTERVIEW SESSION		
	DP - HR	DP- RM	HR - RM
2 Bands in the 0-2000 Hz	None	PSD 2	None
3 Bands in the 0-2000 Hz	None	None	None
4 Bands in the 0-2000 Hz	PSD 3	PSD 3	None
5 Bands in the 0-2000 Hz	PSD 4	PSD 4	None
6 Bands in the 0-2000 Hz	PSD 4	PSD 4, PSD 5	None
7 Bands in the 0-2000 Hz	PSD 5	PSD 5, PSD 6	None
8 Bands in the 0-2000 Hz	PSD 5, PSD 6	PSD 5, PSD 6	None
9 Bands in the 0-2000 Hz	PSD 6	PSD 5, PSD 6, PSD 7	None
10 Bands in the 0-2000 Hz	PSD 2, PSD 7	PSD 6, PSD 7, PSD 8	None
2 Bands in the 0-3000 Hz	None	None	None
3 Bands in the 0-3000 Hz	PSD 2	None	None
4 Bands in the 0-3000 Hz	None	None	None
5 Bands in the 0-3000 Hz	None	PSD 3	None
6 Bands in the 0-3000 Hz	PSD 3	PSD 3	None
7 Bands in the 0-3000 Hz	None	PSD 3, PSD 4	None
8 Bands in the 0-3000 Hz	PSD 4	PSD 4	None
9 Bands in the 0-3000 Hz	PSD 4	PSD 4, PSD 5	None
10 Bands in the 0-3000 Hz	PSD 5	PSD 4, PSD 5	None
Exponential Bands in the 0-2000 Hz	None	PSD 4	None
Exponential Bands in the 0-3000 Hz	None	None	None
Non-Uniform Bands in the 0-2000 Hz	PSD 2	N/A	N/A
Non-Uniform Bands in the 0-3000 Hz	None	N/A	N/A

Table 171: Statistically Significant Energy Bands during the Reading Session

OPTIMIZATION TECHNIQUES	READING SESSION		
	DP - HR	DP- RM	HR - RM
2 Bands in the 0-2000 Hz	None	None	None
3 Bands in the 0-2000 Hz	None	None	None
4 Bands in the 0-2000 Hz	None	None	None
5 Bands in the 0-2000 Hz	None	None	None
6 Bands in the 0-2000 Hz	None	None	None
7 Bands in the 0-2000 Hz	None	None	None
8 Bands in the 0-2000 Hz	PSD 2	PSD 5	None
9 Bands in the 0-2000 Hz	PSD 2	None	None
10 Bands in the 0-2000 Hz	PSD 2	None	None
2 Bands in the 0-3000 Hz	None	None	None
3 Bands in the 0-3000 Hz	None	None	None
4 Bands in the 0-3000 Hz	None	None	None
5 Bands in the 0-3000 Hz	None	None	None
6 Bands in the 0-3000 Hz	None	None	None
7 Bands in the 0-3000 Hz	None	None	None
8 Bands in the 0-3000 Hz	None	None	None
9 Bands in the 0-3000 Hz	None	PSD 4	None
10 Bands in the 0-3000 Hz	None	None	None
Exponential Bands in the 0-2000 Hz	PSD 2	None	None
Exponential Bands in the 0-3000 Hz	None	None	None
Non-Uniform Bands in the 0-2000 Hz	None	N/A	N/A
Non-Uniform Bands in the 0-3000 Hz	None	N/A	N/A

Table 172 shows the statistically significant energy bands' mean value shifts of Depressed – High Risk Suicidal (DP-HR) pairwise group during the interview session. All of the female patients' mean values of the statistically significant energy bands are decreased while moving from the mean value of the High Risk Suicidal (HR) patients' to the mean value of the Depressed (DP) patients'. This result is found in the opposite direction for the male patients.

Table 172: Statistically Significant Energy Bands' Mean Value Shifts of DP-HR (Depressed-High Risk Suicidal) Pairwise Group during the Interview Session

OPTIMIZATION TECHNIQUES	DP - HR Interview Session (HR-->DP)	
	Female Patients	Male Patients
PSD 3 (4 Bands in the 0-2000 Hz)	decrease	increase
PSD 4 (5 Bands in the 0-2000 Hz)	decrease	increase
PSD 4 (6 Bands in the 0-2000 Hz)	decrease	increase
PSD 5 (7 Bands in the 0-2000 Hz)	decrease	increase
PSD 5 (8 Bands in the 0-2000 Hz)	decrease	increase
PSD 6 (8 Bands in the 0-2000 Hz)	decrease	increase
PSD 6 (9 Bands in the 0-2000 Hz)	decrease	increase
PSD 2 (10 Bands in the 0-2000 Hz)	decrease	increase
PSD 7 (10 Bands in the 0-2000 Hz)	decrease	increase
PSD 3 (6 Bands in the 0-3000 Hz)	decrease	increase
PSD 4 (8 Bands in the 0-3000 Hz)	decrease	increase
PSD 4 (9 Bands in the 0-3000 Hz)	decrease	increase
PSD 5 (10 Bands in the 0-3000 Hz)	decrease	increase
PSD 2 (Non-Uniform in the 0-2000 Hz)	decrease	increase

The statistically significant gender differences between High Risk Suicidal (HR) and Depressed (DP) patients during the interview session are listed below with their mean values and their moving behaviors.

- PSD 3 (4 Bands in 0-2000 Hz) in the Interview Session:
 - **Female:** HR: 0.0197, DP: 0.0155 → 0.0042 decrease from HR to DP → shifting left
 - **Male:** HR: 0.0125, DP: 0.0285 → 0.016 increase from HR to DP → shifting right
- PSD 4 (5 Bands in 0-2000 Hz) in the Interview Session:

- **Female:** HR: 0.0133, DP: 0.0103 → 0.003 decrease from HR to DP → shifting left
- **Male:** HR: 0.0089, DP: 0.0202 → 0.0113 increase from HR to DP → shifting right
- PSD 4 (6 Bands in 0-2000 Hz) in the Interview Session:
 - **Female:** HR:0.0148, DP:0.0114 → 0.0034 decrease from HR to DP → shifting left
 - **Male:** HR:0.0089, DP: 0.0201 → 0.0112 increase from HR to DP → shifting right
- PSD 5 (7 Bands in 0-2000 Hz) in the Interview Session:
 - **Female:** HR: 0.0108, DP: 0.0076 → 0.0032 decrease from HR to DP → shifting left
 - **Male:** HR: 0.0067, DP: 0.0155 → 0.0088 increase from HR to DP → shifting right
- PSD 5 (8 Bands in 0-2000 Hz) in the Interview Session:
 - **Female:** HR: 0.0119, DP: 0.0097 → 0.0022 decrease from HR to DP → shifting left
 - **Male:** HR:0.0069, DP: 0.0156 → 0.0087 increase from HR to DP → shifting right
- PSD 6 (8 Bands in 0-2000 Hz) in the Interview Session:
 - **Female:** HR:0.0080, DP: 0.0062 → 0.0018 decrease from HR to DP → shifting left

- **Male:** HR:0.0056, DP: 0.0128 → 0.0072 increase from HR to DP → shifting right
- PSD 6 (9 Bands in 0-2000 Hz) in the Interview Session:
 - **Female:** HR:0.0092, DP: 0.0063 → 0.0029 decrease from HR to DP → shifting left
 - **Male:** HR:0.0055, DP: 0.0126 → 0.0071 increase from HR to DP → shifting right
- PSD 2 (10 Bands in 0-2000 Hz) in the Interview Session:
 - **Female:** HR:0.2850, DP: 0.2619 → 0.0231 decrease from HR to DP → shifting left
 - **Male:** HR: 0.2026, DP: 0.2628 → 0.0602 increase from HR to DP → shifting right
- PSD 7 (10 Bands in 0-2000 Hz) in the Interview Session:
 - **Female:** HR:0.0075, DP: 0.0053 → 0.0022 decrease from HR to DP → shifting left
 - **Male:** HR:0.0047, DP: 0.0107 → 0.006 increase from HR to DP → shifting right
- PSD 3 (6 Bands in 0-3000 Hz) in the Interview Session:
 - **Female:** HR:0.0188, DP: 0.0154 → 0.0034 decrease from HR to DP → shifting left
 - **Male:** HR: 0.0122, DP:0.0270 → 0.0148 increase from HR to DP → shifting right
- PSD 4 (8 Bands in 0-3000 Hz) in the Interview Session:

- **Female:** HR:0.0129, DP: 0.0096 → 0.0033 decrease from HR to DP → shifting left
- **Male:** HR:0.0085, DP: 0.0191 → 0.0106 increase from HR to DP → shifting right
- PSD 4 (9 Bands in 0-3000 Hz) in the Interview Session:
 - **Female:** HR:0.0139, DP: 0.0110 → 0.0029 decrease from HR to DP → shifting left
 - **Male:** HR:0.0086, DP: 0.0191 → 0.0105 increase from HR to DP → shifting right
- PSD 5 (10 Bands in 0-3000 Hz) in the Interview Session:
 - **Female:** HR:0.0097, DP: 0.0073 → 0.0024 decrease from HR to DP → shifting left
 - **Male:** HR:0.0066, DP: 0.0148 → 0.0082 increase from HR to DP → shifting right
- PSD 2 (Non-Uniform Edged Bands in 0-2000 Hz) in the Interview Session:
 - **Female:** HR:0.0077, DP: 0.0060 → 0.0017 decrease from HR to DP → shifting left
 - **Male:** HR:0.0054, DP: 0.0121 → 0.0067 increase from HR to DP → shifting right

Table 173 shows the statistically significant energy bands' mean value shifts of the Depressed – High Risk Suicidal (DP-HR) pairwise group during the reading session.

All of the female patients' mean values of the statistically significant energy bands are decreased while moving from the mean value of the High Risk Suicidal (HR) patients' to the mean value of the Depressed (DP) patients'. This result is found in the opposite direction of the male patients.

Table 173: Statistically Significant Energy Bands' Mean Value Shifts of DP-HR (Depressed-High Risk Suicidal) Pairwise Group during the Reading Session

OPTIMIZATION TECHNIQUES	DP- HR Reading Session (HR-->DP)	
	Female Patients	Male Patients
PSD 2 (8 Bands in the 0-2000 Hz)	decrease	increase
PSD 2 (9 Bands in the 0-2000 Hz)	decrease	increase
PSD 2 (10 Bands in the 0-2000 Hz)	decrease	increase
PSD 2 (Exponential Bands in the 0-2000 Hz)	decrease	increase

The statistically significant gender differences between Depressed (DP) and High Risk Suicidal (HR) patients during the reading session are listed below with their mean values and their moving behaviors.

- PSD 2 (8 Bands in 0-2000 Hz) in the Reading Session:
 - **Female:** HR: 0.3113, DP: 0.2732 → 0.0381 decrease from HR to DP → shifting left
 - **Male:** HR: 0.2540, DP: 0.2894 → 0.0354 increase from HR to DP → shifting right
- PSD 2 (9 Bands in 0-2000 Hz) in the Reading Session:
 - **Female:** HR:0.3159, DP: 0.2803 → 0.0356 decrease from HR to DP → shifting left

- **Male:** HR:0.2455, DP: 0.2866 → 0.0411 increase from HR to DP → shifting right
- PSD 2 (10 Bands in 0-2000 Hz) in the Reading Session:
 - **Female:** HR:0.3148, DP: 0.2883 → 0.0265 decrease from HR to DP → shifting left
 - **Male:** HR: 0.2288, DP: 0.2779 → 0.0491 increase from HR to DP → shifting right
- PSD 2 (Exponential Bands in 0-2000 Hz) in the Reading Session:
 - **Female:** HR:0.3225, DP: 0.2840 → 0.0385 decrease from HR to DP → shifting left
 - **Male:** HR: 0.2583, DP: 0.2973 → 0.039 increase from HR to DP → shifting right

Table 174 shows the statistically significant energy bands' mean value shifts of the Depressed – Remitted (DP-RM) pairwise group during the interview session. All of the female patients' mean values of the statistically significant energy bands are increased while moving from the mean value of the Depressed (DP) patients' to the mean value of the Remitted (RM) patients'. For the male patients, all results are in the opposite direction to the female patients' results.

Table 174: Statistically Significant Energy Bands' Mean Value Shifts of DP-RM (Depressed-Remitted) Pairwise Group during the Interview Session

OPTIMIZATION TECHNIQUES	DP- RM Interview Session (DP-->RM)	
	Female Patients	Male Patients
PSD 2 (2 Bands in the 0-2000 Hz)	increase	decrease
PSD 3 (4 Bands in the 0-2000 Hz)	increase	decrease
PSD 4 (5 Bands in the 0-2000 Hz)	increase	decrease
PSD 4 (6 Bands in the 0-2000 Hz)	increase	decrease
PSD 5 (6 Bands in the 0-2000 Hz)	increase	decrease
PSD 5 (7 Bands in the 0-2000 Hz)	increase	decrease
PSD 6 (7 Bands in the 0-2000 Hz)	increase	decrease
PSD 5 (8 Bands in the 0-2000 Hz)	increase	decrease
PSD 6 (8 Bands in the 0-2000 Hz)	increase	decrease
PSD 5 (9 Bands in the 0-2000 Hz)	increase	decrease
PSD 6 (9 Bands in the 0-2000 Hz)	increase	decrease
PSD 7 (9 Bands in the 0-2000 Hz)	increase	decrease
PSD 6 (10 Bands in the 0-2000 Hz)	increase	decrease
PSD 7 (10 Bands in the 0-2000 Hz)	increase	decrease
PSD 8 (10 Bands in the 0-2000 Hz)	increase	decrease
PSD 2 (3 Bands in the 0-3000 Hz)	increase	decrease
PSD 3 (5 Bands in the 0-3000 Hz)	increase	decrease
PSD 3 (6 Bands in the 0-3000 Hz)	increase	decrease
PSD 3 (7 Bands in the 0-3000 Hz)	increase	decrease
PSD 4 (7 Bands in the 0-3000 Hz)	increase	decrease
PSD 4 (8 Bands in the 0-3000 Hz)	increase	decrease
PSD 4 (9 Bands in the 0-3000 Hz)	increase	decrease
PSD 5 (9 Bands in the 0-3000 Hz)	increase	decrease
PSD 4 (10 Bands in the 0-3000 Hz)	increase	decrease
PSD 5 (10 Bands in the 0-3000 Hz)	increase	decrease
PSD 4 (Exponential in the 0-2000 Hz)	increase	decrease

The statistically significant gender differences between Depressed (DP) and Remitted (RM) patients during the interview session are listed below with their mean values and their moving behaviors.

- PSD 2 (2 Bands in 0-2000 Hz) in the Interview Session:

- **Female:** DP: 0.03, RM: 0.0432 → 0.0132 increase from DP to RM → shifting right
- **Male:** DP: 0.0477, RM: 0.0404 → 0.0073 decrease from DP to RM → shifting left
- PSD 3 (4 Bands in 0-2000 Hz) in the Interview Session:
 - **Female:** DP: 0.0155, RM: 0.0228 → 0.0073 increase from DP to RM → shifting right
 - **Male:** DP: 0.0285, RM: 0.0204 → 0.0081 decrease from DP to RM → shifting left
- PSD 4 (5 Bands in 0-2000 Hz) in the Interview Session:
 - **Female:** DP:0.0103, RM: 0.0158 → 0.0055 increase from DP to RM → shifting right
 - **Male:** DP: 0.0202, RM: 0.0154 → 0.0048 decrease from DP to RM → shifting left
- PSD 4 (6 Bands in 0-2000 Hz) in the Interview Session:
 - **Female:** DP:0.0114, RM:0.0165 → 0.0051 increase from DP to RM → shifting right
 - **Male:** DP:0.0201, RM: 0.0139 → 0.0062 decrease from DP to RM → shifting left
- PSD 5 (6 Bands in 0-2000 Hz) in the Interview Session:
 - **Female:** DP:0.0092, RM:0.0146 → 0.0054 increase from DP to RM → shifting right

- **Male:** DP:0.0159, RM: 0.0134 → 0.0025 decrease from DP to RM → shifting left
- PSD 5 (7 Bands in 0-2000 Hz) in the Interview Session:
 - **Female:** DP: 0.0077, RM: 0.0112 → 0.0035 increase from DP to RM → shifting right
 - **Male:** DP: 0.0155, RM: 0.0109 → 0.0046 decrease from DP to RM → shifting left
- PSD 6 (7 Bands in 0-2000 Hz) in the Interview Session:
 - **Female:** DP:0.0082, RM: 0.0130 → 0.0048 increase from DP to RM → shifting right
 - **Male:** DP:0.0131, RM: 0.0116 → 0.0015 decrease from DP to RM → shifting left
- PSD 5 (8 Bands in 0-2000 Hz) in the Interview Session:
 - **Female:** DP:0.0097, RM: 0.0139 → 0.0042 increase from DP to RM → shifting right
 - **Male:** DP:0.0157, RM: 0.0110 → 0.0047 decrease from DP to RM → shifting left
- PSD 6 (8 Bands in 0-2000 Hz) in the Interview Session:
 - **Female:** DP:0.0062, RM: 0.0093 → 0.0031 increase from DP to RM → shifting right
 - **Male:** DP:0.0128, RM: 0.0095 → 0.0033 decrease from DP to RM → shifting left
- PSD 5 (9 Bands in 0-2000 Hz) in the Interview Session:

- **Female:** DP:0.0123, RM: 0.0172 → 0.0049 increase from DP to RM → shifting right
- **Male:** DP:0.0150, RM: 0.0127 → 0.0023 decrease from DP to RM → shifting left
- PSD 6 (9 Bands in 0-2000 Hz) in the Interview Session:
 - **Female:** DP:0.0062, RM: 0.0090 → 0.0028 increase from DP to RM → shifting right
 - **Male:** DP: 0.0126, RM: 0.0086 → 0.004 decrease from DP to RM → shifting left
- PSD 7 (9 Bands in 0-2000 Hz) in the Interview Session:
 - **Female:** DP:0.0058, RM: 0.0094 → 0.0036 increase from DP to RM → shifting right
 - **Male:** DP: 0.0109, RM: 0.0089 → 0.002 decrease from DP to RM → shifting left
- PSD 6 (10 Bands in 0-2000 Hz) in the Interview Session:
 - **Female:** DP:0.0083, RM: 0.0119 → 0.0036 increase from DP to RM → shifting right
 - **Male:** DP:0.0128, RM: 0.0091 → 0.0037 decrease from DP to RM → shifting left
- PSD 7 (10 Bands in 0-2000 Hz) in the Interview Session:
 - **Female:** DP:0.0052, RM:0.0076 → 0.0024 increase from DP to RM → shifting right

- **Male:** DP:0.0107, RM: 0.0076 → 0.0031 decrease from DP to RM → shifting left
- PSD 8 (10 Bands in 0-2000 Hz) in the Interview Session:
 - **Female:** DP:0.0050, RM: 0.0082 → 0.0032 increase from DP to RM → shifting right
 - **Male:** DP:0.0094, RM: 0.0077 → 0.0017 decrease from DP to RM → shifting left
- PSD 2 (3 Bands in 0-3000 Hz) in the Interview Session:
 - **Female:** DP:0.0286, RM: 0.0413 → 0.0127 increase from DP to RM → shifting right
 - **Male:** DP:0.0444, RM: 0.0371 → 0.0073 decrease from DP to RM → shifting left
- PSD 3 (5 Bands in 0-3000 Hz) in the Interview Session:
 - **Female:** DP:0.0157, RM: 0.0236 → 0.0079 increase from DP to RM → shifting right
 - **Male:** DP: 0.0266, RM: 0.0219 → 0.0047 decrease from DP to RM → shifting left
- PSD 3 (6 Bands in 0-3000 Hz) in the Interview Session:
 - **Female:** DP: 0.0154, RM: 0.0224 → 0.007 increase from DP to RM → shifting right
 - **Male:** DP: 0.0270, RM: 0.0195 → 0.0075 decrease from DP to RM → shifting left
- PSD 3 (7 Bands in 0-3000 Hz) in the Interview Session:

- **Female:** DP:0.0213, RM: 0.0289 → 0.0076 increase from DP to RM → shifting right
- **Male:** DP:0.0261, RM: 0.0220 → 0.0041 decrease from DP to RM → shifting left
- PSD 4 (7 Bands in 0-3000 Hz) in the Interview Session:
 - **Female:** DP:0.0111, RM: 0.0173 → 0.0062 increase from DP to RM → shifting right
 - **Male:** DP:0.0190, RM: 0.0158 → 0.0032 decrease from DP to RM → shifting left
- PSD 4 (8 Bands in 0-3000 Hz) in the Interview Session:
 - **Female:** DP:0.0096, RM: 0.0142 → 0.0046 increase from DP to RM → shifting right
 - **Male:** DP:0.0190, RM: 0.0135 → 0.0055 decrease from DP to RM → shifting left
- PSD 4 (9 Bands in 0-3000 Hz) in the Interview Session:
 - **Female:** DP: 0.0111, RM: 0.0159 → 0.0048 increase from DP to RM → shifting right
 - **Male:** DP:0.0192, RM: 0.0133 → 0.0059 decrease from DP to RM → shifting left
- PSD 5 (9 Bands in 0-3000 Hz) in the Interview Session:
 - **Female:** DP:0.0088, RM: 0.0140 → 0.0052 increase from DP to RM → shifting right

- **Male:** DP:0.0147, RM: 0.0125 → 0.0022 decrease from DP to RM → shifting left
- PSD 4 (10 Bands in 0-3000 Hz) in the Interview Session:
 - **Female:** DP:0.0151, RM: 0.0209 → 0.0058 increase from DP to RM → shifting right
 - **Male:** DP:0.0185, RM: 0.0154 → 0.0031 decrease from DP to RM → shifting left
- PSD 5 (10 Bands in 0-3000 Hz) in the Interview Session:
 - **Female:** DP:0.0073, RM: 0.0108 → 0.0035 increase from DP to RM → shifting right
 - **Male:** DP:0.0148, RM: 0.0108 → 0.004 decrease from DP to RM → shifting left
- PSD 4 (Exponential Bands in 0-2000 Hz) in the Interview Session:
 - **Female:** DP: 0.0306, RM: 0.0442 → 0.0136 increase from DP to RM → shifting right
 - **Male:** DP: 0.0484, RM: 0.0407 → 0.0077 decrease from DP to RM → shifting left

Table 175 shows the statistically significant energy bands' mean value shifts of the Depressed – Remitted (DP-RM) pairwise group during the reading session. All of the female patients' mean values of the statistically significant energy bands are increased while moving from the mean value of the Depressed (DP) patients' to the mean value of

the Remitted (RM) patients'. This result is found in the opposite direction of the male patients.

Table 175: Statistically Significant Energy Bands' Mean Value Shifts of DP-RM (Depressed-Remitted) Pairwise Group during the Reading Session

OPTIMIZATION TECHNIQUES	DP- RM Reading Session (DP-->RM)	
	Female Patients	Male Patients
PSD 5 (8 Bands in the 0-2000 Hz)	increase	decrease
PSD 4 (9 Bands in the 0-3000 Hz)	increase	decrease

The statistically significant gender differences between Depressed (DP) and Remitted (RM) patients during the reading session are listed below with their mean values and their moving behaviors.

- PSD 5 (8 Bands in 0-2000 Hz) in the Reading Session:
 - **Female:** DP:0.0091, RM: 0.0114 → 0.0023 increase from DP to RM → shifting right
 - **Male:** DP: 0.0123, RM: 0.0099 → 0.0024 decrease from DP to RM → shifting left
- PSD 4 (9 Bands in 0-3000 Hz) in the Reading Session:
 - **Female:** DP:0.0103, RM: 0.0135 → 0.0032 increase from DP to RM → shifting right
 - **Male:** DP:0.0148, RM: 0.0122 → 0.0026 decrease from DP to RM → shifting left

5 Discussion and Conclusion

There are statistically significant gender differences in different optimized energy bands for the Depressed (DP) and High Risk Suicidal (HR) pairwise group during the interview session. In all of them, the female patients' mean value decreases and the male patient's mean value increases significantly when moving from the HR pairwise group to the DP pairwise group. So, they are moving opposite to each other. The energy bands shown below are the energy bands which are statistically significant and different for genders and their frequency ranges are also listed below.

- PSD 3 (4 optimized bands in the 0-2000 Hz) → energy band in the 1000-1500 Hz
- PSD 4 (5 optimized bands in the 0-2000 Hz) → energy band in the 1200-1600 Hz
- PSD 4 (6 optimized bands in the 0-2000 Hz) → energy band in the 1000-1333 Hz
- PSD 5 (7 optimized bands in the 0-2000 Hz) → energy band in the 1143-1429 Hz
- PSD 5 (8 optimized bands in the 0-2000 Hz) → energy band in the 1000-1250 Hz
- PSD 6 (8 optimized bands in the 0-2000 Hz) → energy band in the 1250-1500 Hz
- PSD 6 (9 optimized bands in the 0-2000 Hz) → energy band in the 1111-1333 Hz

- PSD 2 (10 optimized bands in the 0-2000 Hz)→ energy band in the 200- 400 Hz
- PSD 7(10 optimized bands in the 0-2000 Hz)→ energy band in the 1200-1400 Hz
- PSD 3 (6 optimized bands in the 0-3000 Hz)→ energy band in the 1000- 1500 Hz
- PSD 4 (8 optimized bands in the 0-3000 Hz)→ energy band in the 1125- 1500 Hz
- PSD 4 (9 optimized bands in the 0-3000 Hz)→ energy band in the 1000- 1333 Hz
- PSD 5(10 optimized bands in the 0-3000 Hz)→ energy band in the 1200-1500 Hz
- PSD 2 (Non-uniform edged bands in the 0-2000 Hz)→ Table 68 in Chapter 4

There are statistically significant gender differences in different optimized energy bands for the Depressed (DP) and High Risk Suicidal (HR) pairwise group during the reading session. The female patients' mean value decreases and the male patient's mean value increases significantly when moving from the HR to the DP. In both of the interview and reading sessions of the DP-HR pairwise group, the female patients' mean value decreases and the male patient's mean value increases significantly when moving from the high risk suicidal (HR) state to the depressed (DP) state. The energy bands shown below are the energy bands which are statistically significant and different for genders and their frequency ranges are also listed below.

- PSD 2 (8 optimized bands in the 0-2000 Hz) → energy band in the 250-500 Hz
- PSD 2 (9 optimized bands in the 0-2000 Hz) → energy band in the 222-445 Hz
- PSD 2 (10 optimized bands in the 0-2000 Hz) → energy band in the 200-400 Hz
- PSD 2 (Exponential bands in the 0-2000 Hz) → energy band in the 250-500 Hz

There are no statistically significant gender differences in different optimized energy bands for the High Risk Suicidal (HR) and Remitted (RM) pairwise group during the interview session and during the reading session.

There are statistically significant gender differences in different optimized energy bands for the Depressed (DP) and Remitted (RM) pairwise group during the interview session. The female patients' mean value increases and the male patient's mean value decreases significantly when moving from the DP pairwise group to the RM pairwise group. So, they are moving opposite to each other. The energy bands shown below are the energy bands which are statistically significant and different for genders and their frequency ranges are also listed below.

- PSD 2 (2 optimized bands in the 0-2000 Hz) → energy band in the 1000-2000 Hz
- PSD 3 (4 optimized bands in the 0-2000 Hz) → energy band in the 1000-1500 Hz
- PSD 4 (5 optimized bands in the 0-2000 Hz) → energy band in the 1200-1600 Hz

- PSD 4 (6 optimized bands in the 0-2000 Hz)→ energy band in the 1000-1333 Hz
- PSD 5 (6 optimized bands in the 0-2000 Hz)→ energy band in the 1333-1666 Hz
- PSD 5 (7 optimized bands in the 0-2000 Hz)→ energy band in the 1143-1429 Hz
- PSD 6 (7 optimized bands in the 0-2000 Hz)→ energy band in the 1429-1715 Hz
- PSD 5 (8 optimized bands in the 0-2000 Hz)→ energy band in the 1000-1250 Hz
- PSD 6 (8 optimized bands in the 0-2000 Hz)→ energy band in the 1250-1500 Hz
- PSD 5 (9 optimized bands in the 0-2000 Hz)→ energy band in the 889- 1111 Hz
- PSD 6 (9 optimized bands in the 0-2000 Hz)→ energy band in the 1111-1333Hz
- PSD 7 (9 optimized bands in the 0-2000 Hz)→ energy band in the 1333-1555 Hz
- PSD 6 (10 optimized bands in the 0-2000 Hz)→ energy band in the 1000-1200 Hz
- PSD 7 (10 optimized bands in the 0-2000 Hz)→ energy band in the 1200-1400 Hz

- PSD 8 (10 optimized bands in the 0-2000 Hz)→ energy band in the 1400-1600 Hz
- PSD 2 (3 optimized bands in the 0-3000 Hz)→ energy band in the 1000-2000 Hz
- PSD 3 (5 optimized bands in the 0-3000 Hz)→ energy band in the 1200-1800 Hz
- PSD 3 (6 optimized bands in the 0-3000 Hz)→ energy band in the 1000-1500 Hz
- PSD 3 (7 optimized bands in the 0-3000 Hz)→ energy band in the 857-1286 Hz
- PSD 4 (7 optimized bands in the 0-3000 Hz)→ energy band in the 1286-1714 Hz
- PSD 4 (8 optimized bands in the 0-3000 Hz)→ energy band in the 1125-1500 Hz
- PSD 4 (9 optimized bands in the 0-3000 Hz)→ energy band in the 1000-1333 Hz
- PSD 5 (9 optimized bands in the 0-3000 Hz)→ energy band in the 1333-1666 Hz
- PSD 4 (10 optimized bands in the 0-3000 Hz)→ energy band in the 900-1200 Hz
- PSD 5(10 optimized bands in the 0-3000 Hz)→ energy band in the 1200-1500 Hz

- PSD 4 (Exponential bands in the 0-2000 Hz)→ energy band in the 1000- 2000 Hz

There are statistically significant gender differences in different optimized energy bands for the Depressed (DP) and Remitted (RM) pairwise group during the reading session. The female patients' mean value increases and the male patient's mean value decreases significantly when moving from the DP pairwise group to the RM pairwise group. In both of the interview and reading sessions of DP-RM pairwise group, the female patients' mean value increases and the male patient's mean value decreases significantly when moving from the depressed (DP) state to the remitted (RM) state. The energy bands shown below are the energy bands which are statistically significant and different for genders and their frequency ranges are also listed below.

- PSD 5 (8 optimized bands in the 0-2000 Hz)→ energy band in the 1000-1250 Hz
- PSD 4 (9 optimized bands in the 0-3000 Hz)→ energy band in the 1000-1333 Hz

According to the results, spontaneous speech (interview session) is more effective for revealing the gender differences than the controlled reading speech (reading session). There are 14 statistically significant features that are different for different genders for the DP-HR pairwise group during the interview session. There are 26 statistically significant features that are different for different genders for the DP-RM pairwise group during the interview session. Totally, this makes 40 statistically significant features that are different for different genders during the interview sessions. There are 4 statistically

significant features that are different for different genders for the DP-HR pairwise group during the reading session and there are only 2 statistically significant features that are different for different genders for the DP-RM pairwise group during the reading session. Totally, this makes 6 statistically significant features that are different for different genders during the reading sessions.

CHAPTER VI

SUMMARY AND CONCLUSIONS

Recognition of suicide risk is very important in suicide prevention. The research in this dissertation could be very useful in helping with the development of algorithms for a diagnostic tool that can assess the risk of committing suicide. In this research, statistical analyses were performed on the mel-frequency cepstral coefficients features and the optimized energy bands features to determine if these acoustical properties of speech change when the patient transitions from the depressed state to the high risk suicidal state. Results of these statistical analyses show that vocalization is sensitive to the physiological irregularities caused by depression and suicidal risk. Additionally, it is illustrated that there exists gender specific differences on the optimized energy bands.

In Chapter III, “Objective Estimation of Suicidal Risk Using Mel-Frequency Cepstral Coefficients”, different numbers of mel-frequency coefficients (4 MFCCs, 8 MFCCs, 12 MFCCs, 16 MFCC, and 20 MFCCs) were analyzed with and without environmental compensation for both genders during the interview and the reading sessions. The results show that the classification rate for discriminating the high risk suicidal patients from the depressed patients is much better without environmental compensation for both male and female patients. Increasing the number of mel-frequency cepstrum coefficients (MFCCs) gave better classification rates for most of the analyses for the female and the male patients. Optimal sets of MFCCs are also found using the cross validation technique to maximize the classification rates of discriminating the high

risk suicidal patients from the depressed patients using fewer mel-frequency cepstral coefficients. The Depressed-High Risk Suicidal (DP-HR) pairwise group classification rates are better with the male patients. It is 75.20 % during the interview session and it is 78.00 % during the reading session. On the other hand, the DP-HR pairwise group classification for the female patients is 66.40 % during the interview session and 63.90% during the reading session. The HR individual performance of the male patients (interview session: 97.50%, reading session: 93.00%) performance was better than the female patients' individual HR performance (interview session: 70.10%, reading session: 71.10%). The DP individual performance of the male patients (89.80%) performance was better than the female patients' DP individual performance (70.10%) for the reading session and they were about the same for the interview session (female: 78.90%, male: 78.60%). The aim of this research was estimating the suicidal risk using the mel-frequency cepstral coefficients (MFCCs) with high classification rates and the results show that the MFCCs are useful indicators for DP-HR discrimination with high classification rates.

In Chapter IV, "Objective Estimation of Suicidal Risk Using Optimized Energy Bands", the aim of this research was finding optimized energy bands that give better classification rates than the regular energy bands (0-500 Hz, 500- 1000 Hz, 1000-1500 Hz, 1500-2000 Hz). For the female patients, increasing the number of energy bands, increasing band number & band range, exponential band edges, non-uniform band edges, non-uniform band edges & band ranges are good techniques to optimize the energy bands for the DP-HR pairwise group during both sessions. The exponential band edges & increasing the band range technique are optimal techniques for the DP-HR pairwise

group during the reading session using the quadratic classifier. Increasing the number of bands is an optimal technique for the Depressed-Remitted (DP-RM) pairwise group during the both sessions. Increasing band range and increasing band number & band range are good techniques for the DP-RM pairwise during both sessions using the linear and the cross validated classifiers. Using the quadratic classifier, increasing band range, increasing band number & band ranges, exponential band edges, exponential band edges & increasing band range are good techniques for the DP-RM reading session only. The exponential band edge technique is a good optimization technique for the DP-RM only during the interview session with the linear and the cross validated classifiers. Increasing the number of bands and increasing the number of bands& band range are two optimization techniques for the High Risk Suicidal – Remitted (HR-RM) pairwise group during both sessions. The exponential band edge technique is a good optimization technique for the HR-RM pairwise group during the reading session. The exponential band range is a good technique for the HR-RM pairwise group during the interview session using the cross validated classifier. For the HR-RM pairwise group during the reading session, the exponential band edges & increased band range is an optimal technique using the linear classifier.

For the male patients, increasing the number of energy bands, increasing band range, increasing the number of bands & increase range, exponential bands edges & increasing band range, non-uniform band edges, non-uniform band edges & band ranges are good techniques to optimize the energy bands for the DP-HR pairwise group during the both sessions. The exponential band edges technique is an optimal technique for the DP-HR pairwise group during the reading session. The increasing number of bands is an

optimal technique for the DP-RM interview session using the linear and the quadratic classifiers, and it is optimal for the DP-RM reading session using the linear classifier. Increasing the number of energy bands, increasing band range, increasing the number of bands & increase range, exponential bands edges & increasing band range are good techniques to optimize the energy bands for the HR-RM pairwise group during the both sessions. The exponential band edges technique is an optimal technique for the HR-RM pairwise group during the reading session using the quadratic classifier.

In Chapter V, “Gender Specific Differences on Optimized Energy Bands”, the aim of this research was finding gender specific differences on the optimized energy bands. In the DP-HR pairwise group during the interview session, 14 statistically significant energy bands were found. These bands have different characteristics for different genders. The female patients’ energy bands’ mean values decrease when moving from the HR pairwise group to the DP pairwise group but the male patients’ energy bands’ mean values increase. The statistically significant features are: PSD 2 (10 bands in 0-2000 Hz & non-uniform band edges in the 0-2000 Hz), PSD 3 (4 bands in 0-2000 Hz & 6 bands in 0-3000 Hz), PSD 4 (5 bands and 6 bands in 0-2000 Hz & 8 bands and 9 bands in 0-3000 Hz), PSD 5 (7 and 8 bands in 0-2000 Hz & 10 bands in 0-3000 Hz), PSD 6 (8 and 9 bands in 0-2000 Hz), and PSD 7 (10 bands in 0-2000 Hz). During the reading session of the DP-HR pairwise group, the same characteristics as the interview session were observed for 4 statistically significant energy bands. The statistically significant features are: PSD 2 (8 bands, 9 bands, 10 bands and exponential band edges in the 0-2000 Hz).

In the DP-RM pairwise group during the interview session, 26 statistically significant energy bands were found. These bands have different characteristics for different genders. Female patients' energy bands' mean value increases when moving from the DP pairwise group to the RM pairwise group but the male patients' energy bands' mean value decreases. The statistically significant features are: PSD 2 (2 bands in 0-2000 Hz & 3 bands in the 0-3000 Hz), PSD 3 (4 bands in 0 -2000 Hz & 5 bands, 6 bands, 7 bands in 0-3000 Hz), PSD 4 (5 bands, 6 bands, exponential band edges in 0-2000 Hz & 7 bands, 8 bands, 9 bands, 10 bands in 0-3000 Hz), PSD 5 (6 bands, 7 bands, 8 bands, 9 bands in 0-2000 Hz & 9 bands, 10 bands in the 0-3000 Hz), PSD 6 (7 bands, 8 bands, 9 bands, 10 bands in 0-2000 Hz), PSD 7 (9 bands and 10 bands in 0-2000 Hz), and PSD 8 (10 bands in the 0-2000 Hz). During the reading session of the DP-RM pairwise group, the same characteristics as with the interview session were observed for 2 statistically significant energy bands. The statistically significant features are: PSD 4 (9 bands in the 0-3000 Hz) and PSD 5 (8 bands in the 0-2000 Hz). In the HR-RM pairwise group during the interview and the reading sessions, there were no statistically significant energy bands.

REFERENCES

- [1] Centers for Disease Control and Prevention. Web-based Injury Statistics Query and Reporting System (WISQARS) [Online]. (2010). National Center for Injury Prevention and Control, Centers for Disease Control and Prevention (producer). [Cited 2010 June 23]. Available from: URL: www.cdc.gov/injury/wisqars/index.html
- [2] C. J. L. Murray, A.D. Lopez (eds): "The Global Burden of Disease: A Comprehensive Assessment of Mortality and Disability From Diseases, Injuries, and Risk Factors in 1990 and Projected to 2020", Boston, Harvard School of Public Health, 1996.
- [3] The World Health Report. Geneva: World Health Organization; 1997.
- [4] Available from: URL http://www.allaboutdepression.com/gen_04.html
- [5] D. L. Hoyert, K.D. Kochanek, S. L. Murphy, "Deaths: final data for 1997", National Vital Stat Report, Vol. 47, Issue 19, pp.1-104, 1999.
- [6] Centers for Disease Control and Prevention, National Center for Injury Prevention and Control [Producer]. (2006, January 30). Web-based Injury Statistics Query and Reporting System (WISQARS): Leading causes of death reports, 1999-2003. Retrieved June 19, 2006, from <http://webappa.cdc.gov/sasweb/ncipc/leadcaus10.html>
- [7] Centers for Disease Control and Prevention, National Center for Injury Prevention and Control [Producer]. (2005, November 30). Web-based Injury Statistics Query and Reporting System (WISQARS): Nonfatal injury reports. Retrieved June 19, 2006, from <http://webappa.cdc.gov/sasweb/ncipc/nfirates2001.html>
- [8] E. K. Moscicki, "Epidemiology of completed and attempted suicide: Toward a framework for prevention", Clinical Neuroscience Research, Vol. 1, pp. 310-323, 2001.
- [9] The Office of Applied Studies Report 2006, "Suicidal Thoughts, Suicide Attempts, Major Depressive Episode, and Substance Use among Adults", October 2006.

- [10] Centers for Disease Control and Prevention, National Center for Injury Prevention and Control (producer). Web-based Injury Statistics Query and Reporting System Available online from URL: <http://www.cdc.gov/ncipc/wisqars/default.htm>
- [11] Y. Conwell, D. Brent, "Suicide and Aging I: Patterns of Psychiatric Diagnosis", *International Psychogeriatrics*, Vol. 7, Issue 2, pp. 149 – 164, 1995.
- [12] K. D. Kochanek, S. L. Murphy, R. N. Anderson, C. Scott, "Deaths: Final Data for 2002", *National Vital Statistics Reports*, Vol.53, Issue 5, pp. 1 – 115, October 2004.
- [13] M. M. Weissman, R. C. Bland, G. J. Canino, et al., "Prevalence of Suicide Ideation and Suicide Attempts in Nine Countries", *Psychological Medicine*, Vol. 29, Issue 1, pp. 9 – 17, 1999.
- [14] Suicide Prevention, Awareness, and Support Website, Suicide Statistics, Available online from URL: <http://www.suicide.org/suicide-statistics.html#2005>.
- [15] Available from: URL <http://www.webmd.com/depression/guide/depression-recognizing-signs-of-suicide?page=2>
- [16] J. B. Luoma, J.L. Pearson, C. E. Martin, "Contact with mental health and primary care prior to suicide: a review of the evidence", *American Journal of Psychiatry*, Vol. 159, pp. 909-916, June 2002.
- [17] Suicide Prevention, Awareness, and Support Website, International Suicide Statistics, Available online from URL: <http://www.suicide.org/international-suicide-statistics.html>.
- [18] J. Pirkis, P. Burgess, "Suicide and recency of health care contacts: a systematic review", *British Journal of Psychiatry*, 173:462-474, 1998.
- [19] Peveler, R, Carson, A, and Rodin, G, (2002), "ABC of psychological medicine. Depression in medical patients", *British Medical Journal* 325, 149-52
- [20] Sane, (2000), "Depression and manic depression", Available from: URL www.sane.org.uk/About_Mental_Illness/Depression.htm

- [21] Inskip, HM, Harris, EC, Barraclough, B, (1998), “Lifetimerisk of suicide for affective disorder, alcoholism andschizophrenia”, British Journal of Psychiatry, 172, 35-7
- [22] Simon, GE, VonKroff, M, (1998), “Suicide mortality among patients treated for depression in an insured population”, AmericanJournal of Epidemiology, 147, 155-60
- [23] Weissman, MM, Bland, RC, Canino, GJ, et al (1996),“Cross-National Epidemiolgy of Major Depression and BipolarDisorder”, JAMA, 276 (4), 293-9
- [24] Jenkins, R, Bebbington, P, Brugha, TS, et al (1998),“British psychiatric morbidity survey”, British JournalPsychiatric, 173, 4-7
- [25] R. C. Kessler, W.T. Chiu, O. Demler, E. E. Walters, “Prevalence, Severity, and Comorbidity of Twelve-Month DSM-IV Disorders in the National Comorbidity Survey Replication (NCS-R)”, Archives of General Psychiatry, Vol. 62, Issue 6, pp. 617 – 627, June 2005.
- [26] R. C. Kessler, P. Berglund, O. Demler, R. Jin, D. Koretz, K. R. Merikangas, A. J. Rush, E. E. Walters , P.S. Wang, “ The Epidemiology of Major Depressive Disorder: Results from the National Comorbidity Survey Replication (NCS- R)”, Journal of the American Medical Association, Vol.289, Issue 23, pp. 3095– 3105, June 2003.
- [27] Harris, C, and Barraclough, B, (1998), “Excess mortalityof mental disorder”, British Journal of Psychiatry, 173, (7),11-53
- [28] Harris, EC and Barraclough, B, (1997), ‘Suicide as anoutcome for mental disorders, British Journal of Psychiatry, 170,205-28
- [29] Kerfoot, M, Dyer, E, Harrington, V, Woodham, A,Harrington, R, (1996), “Correlates and Short-term Course ofSelf-poisoning in Adolescents”, Brit Journ Psychiatr,168,38-42
- [30] D. H. Barlow 2005, pp. 248–49 Barlow DH. Abnormal psychology: An integrative approach (5th ed.). Belmont, CA, USA: Thomson Wadsworth; 2005. ISBN 0-534-63356-0.

- [31] K. Hawton, "Assessment of Suicide Risk", *British Journal of Psychiatry*, Vol.150, pp. 145 – 153, 1987.
- [32] M. M. Weissman et al., "Prevalence of Suicide Ideation and Suicide Attempts in Nine Countries", *Psychological Medicine*, Vol. 29, Issue 1, pp. 9 – 17, 1999.
- [33] B. Murray, A. Fortinberry, "Depression Facts and Stats", Available online from URL: http://www.upliftprogram.com/depression_stats.html#5
- [34] Rand Corporation, "The Societal Promise of Improving Care for Depression", Available online from URL: <http://www.rand.org/publications/RB/RB9055>
- [35] A. T. Cheng, "Mental Illness and Suicide: A Case Control Study in East-Taiwan", *Archives of General Psychiatry*, Vol. 52, Issue 7, pp. 594 – 603, July 1995.
- [36] A. T. A. Cheng, "Psychosocial and Psychiatric Risk Factors for Suicide. Case – Control Psychological Autopsy Study", *The British Journal of Psychiatry: The Journal of Mental Science*, Vol. 177, pp. 360 – 365, 2000.
- [37] M. M. Henriksson, H. M. Aro, M. J. Marttunen, M.E. Heikkinen, E.T. Isometsa, et al., "Mental Disorders and Comorbidity in Suicide", *The American Journal of Psychiatry*, Vol. 150, Issue 6, pp. 935 – 940, June 1993.
- [38] Z. Rihmer, "Strategies of Suicide Prevention: Focus on Health Care", *Journal of Affective Disorders*, Vol. 39, Issue 2, pp. 83 – 91, July 1996.
- [39] Szadozky, Z. S. Papp, J. Vitrai, Z. Rihmer, J. Furedi, "The Prevalence of Major Depressive and Bipolar Disorders in Hungary", *Journal of Affective Disorders*, Vol.50, pp. 153 – 162, 1998.
- [40] H. U. Wittchen, B. Knauper, R. D. C. Kessler, "Lifetime Risk Depression", *British Journal of Psychiatry*, Vol. 165, Suppl. 26, pp. 16 – 22, 1994.
- [41] B. G. Druss, R. A. Hoff, R. A. Rosenheck, "Underuse of Antidepressants in Major Depression: Prevalence and Correlates in a National Sample of Young Adults", *The Journal of Clinical Psychiatry*, Vol. 61, pp. 234 – 237, 2000.

- [42] Y. Lecrubier, “Is Depression Under-Recognized and Undertreated?”, *International Clinical Psychopharmacology*, Vol. 13, Suppl.5, s3 – s6, 1998.
- [43] E. Isometsa, M. M. Hendriksson, H. M. Aro, M. E. Heikkinen, K. I. Kouppasalmi, J. K. Lonnqvist, “Suicide in Major Depression”, *American Journal of Psychiatry*, Vol. 151, pp. 530 – 536, 1994.
- [44] Z. Rihmer, J. Barsi, M. Arato, E. Demeter, “Suicide in Subtypes of Primary Major Depression”, *Journal of Affective Disorders*, Vol. 18, pp. 221 – 225, 1990.
- [45] U. A. Andersen, M. Andersen, J. U. Rosholm, L. F. Gram, “Contacts to the Health Care System Prior to Suicide: A Comprehensive Analysis Using Registers for General and Psychiatric Hospital Admissions, Contacts to General Practitioners and Practising Specialists and Drug Prescriptions”, *Acta Psychiatrica Scandinavica*, Vol 102, Issue 2, pp. 126 – 134, 2000.
- [46] Anon, (2003), “Managing Depression”, Update, 6 November 2003
- [47] Barraclough B., Bunch J., Nelson B., et al, “A Hundred Cases of Suicide: Clinical Aspects”, *British Journal of Psychiatry*, Vol. 125, pp. 355 – 373, 1974.
- [48] Vassilas C. A., Morgan H. G., “ General Practitioners’ Contact with Victims of Suicide”, *British Medical Journal*, Vol. 307, pp. 300 – 301, 1993.
- [49] Evans J., “The Health Service Contacts of 87 Suicides”, *Psychiatric Bulletin*, Vol. 18, pp. 548 – 550, 1994.
- [50] L. Rabiner, B H Juang, *Fundamentals of Speech Recognition*, Prentice Hall, New Jersey, 1993.
- [51] W. Holmes, *Speech Synthesis and Recognition*, CRC, 2nd Edition, 2001.
- [52] J.L. Flanagan, *Speech Analysis, Synthesis, and Perception*, Springer –Verlag, New York, 2nd Edition, 1972.
- [53] J. L. Flanagan, C. H. Coker, L. R. Rabiner, R. W. Schafer, N. Umeda, “Synthetic Voices for Computers”, *IEEE Spectrum*, Vol. 7, pp.22 – 45, October 1970.

- [54] L. R. Rabiner, R. W. Schafer, *Digital Processing of Speech Signals*, Prentice Hall, New Jersey, 1978.
- [55] R. Linggard, *Electronic Synthesis of Speech*, Cambridge University Press, 1985
- [56] K. N. Stevens, S. Kasowski, C. G.M. Fant, “An Electrical Analog of the Vocal Tract”, *Journal of Acoustical Society of America*, Vol. 25, Issue 4, 734 – 742, July 1953.
- [57] D. Y. Wong, J. D. Markel, A. H. Gray, “Least Squares Glottal Inverse Filtering from the Acoustic Speech Waveform”, *IEEE Transactions on Acoustics, Speech and Signal Processing*, Vol. 27, Issue 4, pp. 350 – 355, 1979.
- [58] G. J. Borden, K. S. Harris, J. R. Lawrence, *Speech Science Primer: Physiology, Acoustics and Perception of Speech*, William and Wilkins, Baltimore MD, 1994.
- [59] K. Scherer, “Nonlinguistic Vocal Indicators of Emotion and Psychopathology”, in *Emotions in Personality and Psychopathology*, C. E. Izard Ed., NY: Plenum, pp. 493 – 529, 1979.
- [60] J. K. Darby, *Speech Evaluation in Psychiatry*, Grune & Stratton Inc., New York, 1981.
- [61] K. Scherer, B. Zei, “Vocal Indicators of Affective Disorders”, *Psychotherapy and Psychosomatics*, Vol. 49, pp. 179 – 186, 1988.
- [62] J. O. Cavenar, H. Keith, H. Brodie, R. D. Weiner, *Signs & Symptoms in Psychiatry*, pp. 227 – 249, 1983.
- [63] J. Seglas, “Des Troubles du Language Chez Les Alienes”, J. Rueff et Ce Editeurs, *Bibliothèque Medicale Carcot – Debova*, Paris, 1892.
- [64] E. Kraepelin, “Manic Depressive Insanity and Paranoia”, Livingston, Edinburg, United Kingdom, 1921.
- [65] E. W. Scripture, “A Study of Emotions by Speech Transcription”, *Vox*, Vol. 31, pp. 179 – 183, 1921.

- [66] M. Isserlin, "Psychologisch-phonetische Untersuchungen" II. Mitteilung (Psychological-Phonetic Studies. 2nd communication), *Zeitschrift für die Gesamte Neurologie und Psychiatrie*, Vol. 94, pp. 437 – 448, 1925.
- [67] E. Zwirner, "Beitrag zur Sprache der Depressiven", *Z. Psychol. Neurol.*, Vol. 41, pp. 96 – 102, 1930.
- [68] P. Moses, *The Voice of Neurosis*, New York: Grune & Stratton, 1954.
- [69] G.F. Mahl, G. Schulze, "Psychological Research in the Extralinguistic Area", In T.A. Sebeok, A.S. Hayes, & M. C. Bateson (Eds.), *Approaches to Semiotics*, pp. 51 – 124, The Hague: Mouton, 1964.
- [70] P. F. Ostwald, "Acoustic Manifestations of Emotional Disturbances", *Disorders of Communication-Research Publications*, Vol. 42, pp. 450 – 465, 1964.
- [71] J. H. Jones, M. Pansa, "Some Nonverbal Aspects of Depression and Schizophrenia Occurring During the Interview", *Journal of Nervous and Mental Disease*, Vol. 167, pp. 402 – 409, 1979.
- [72] M. Alpert, "Speech and Disturbances in Affect", In J. K. Darby (Ed.), *Speech Evaluation in Psychiatry*, pp. 359 – 368, New York: Grune & Stratton, 1981.
- [73] J. K. Darby, "Speech and Voice Studies in Psychiatric Populations", In J. K. Darby (Ed.), *Speech Evaluation in Psychiatry*, pp. 253 – 284, New York: Grune & Stratton, 1981.
- [74] K. R. Scherer, "Speech and Emotional States", In J. K. Darby (Ed.), *Speech Evaluation in Psychiatry*, pp. 189 – 220, New York: Grune & Stratton, 1981.
- [75] K. R. Scherer, "Vocal Assessments of Affective Disorders", In J. D. Maser (Ed.), *Depression and Expressive Behavior*, pp. 57 – 82, Hillsdale, NJ: Erlbaum, 1987.
- [76] A. W. Siegman, "The Pacing of Speech in Depression", *Depression and Expressive Behavior*, pp. 83 – 102, In J. D. Maser (Ed.), Hillsdale, NJ: Erlbaum, 1987.
- [77] F. Tolkmitt, H. Helfrich, R. Standke, and K. R. Scherer, "Vocal Indicators of

Psychiatric Treatment Effects in Depressives and Schizophrenics”, *Journal of Communication Disorders*, Vol.15, pp.209-222, 1982.

- [78] M. L. Bannister, “An Instrumental and Judgemental Analysis of Voice Samples from Psychiatrically Hospitalized and Nonhospitalized Adolescents”, Unpublished Doctoral Dissertation, University of Kansas, 1972.
- [79] Z. Breznitz, “Verbal Indicators of Depression”, *The Journal of General Psychology*, Vol. 119, pp. 351 – 363, 1992.
- [80] E. Corbitt, K. Malone, G. Hass, J. Mann, “Suicidal Behavior in Patients with Major Depression and Comorbid Personality Disorders”, *Journal of Affective Disorders*, Vol. 39, pp. 61 – 72, 1996.
- [81] J. Leff, E. Abberton, “Voice Pitch Measurements in Schizophrenia and Depression”, *Psychological Medicine*, Vol. 11, Issue 4, pp. 849 – 852, November 1981.
- [82] A. Nilsonne, “Acoustic Analysis of Speech Variables during Depression and after Improvement”, *Acta Psychiatrica Scandinavica*, Volume 76, Issue 3, pp. 235 – 245, 1987.
- [83] D. Rice, G. Abrams, J. Saxman, “Speech and Physiological Correlates of “Flat” Affect”, *Archives of General Psychiatry*, Vol. 20, Issue 5, pp. 566 – 572, May 1969.
- [84] R. Roessler, J. Lester, “Vocal Patterns in Anxiety”, in *Phenomenology and Treatment of Anxiety*, W. E. Fann, A. D. Pokorny, I. Koracau, R. Williams Eds., NY: Spectrum, pp. 225 – 235, 1979.
- [85] J. Saxman, K. Burk, “Speaking F0 and Rate Characteristics of Adult Female Schizophrenics”, *Journal of Speech Hearing Research*, Vol. 11, pp. 194 – 203, 1968.
- [86] S. S. Newman, V. G. Mather, “Analysis of Spoken Language of Patients with Affective Disorders”, *American Journal of Psychiatry*, Vol. 94, pp. 913 – 942, 1938.
- [87] S. H. Eldred, D. B. Price, “The Linguistic Evaluation of Feeling States in

- Psychotherapy”, *Psychiatry*, Vol. 21, Issue 2, pp. 115 – 121, May 1958.
- [88] M. Denber, “Sound Spectrum Analysis of the Mentally Ill”, Master’s Thesis, University of Rochester, Rochester, NY, 1978.
- [89] G. Pinard, J. Y. Roy, L. Tetreault, “Etude du Comportement Verbal dans la Depression Psychotique”, *Rev. Psychol. Appl.* Vol. 22, pp. 229 – 246, 1972.
- [90] J. K. Darby, H. Hollien, “Vocal and Speech Patterns of Depressive Patients”, *Folia Phoniatr*, Vol. 29, pp. 279 – 291, 1977.
- [91] E. Zuberbier, “Zur Schreib und Sprechmotorik der Depressiven”, *Z. Psychother Med. Psychol*, Vol. 7, pp. 239 – 249, 1957.
- [92] W. Weintraub, H. Aronson, “The Application of Verbal Behaviour Analysis to the Study of Psychological Defense Mechanism: IV. Speech Patterns Associated with Depressive Behaviour”, *Journal of Nerv. Ment. Disord.*, Vol. 144, pp. 22 –28, 1967.
- [93] N. N. Markel, M. F. Bein, J. A. Phillis, “The Relationship between Words and Tone-of-Voice”, *Language and Speech*, Vol. 16, pp. 15 – 21, 1973.
- [94] M. Natale, “Effects of Induced Elation- Depression on Speech in the Initial Interview”, *Journal of Consulting and Clinical Psychology*, Vol. 45, pp. 45 – 52, 1977.
- [95] J. D. Teasdale, S. J. Fogarty, “Differential Effects of Induced Mood on Retrieval of Pleasant and Unpleasant Events from Episodic Memory”, *Journal of Abnormal Psychology*, Vol. 88, pp. 248 – 257, 1979.
- [96] M. K. Hinchliffe, M. Lancashire, F. J. Roberts, “Depression: Defense Mechanism in Speech”, *British Journal of Psychiatry*, Vol. 118, pp. 471 – 472, 1971.
- [97] M. K. Mandal, P. Srivastava, S. K. Singh, “Paralinguistic Characteristics of Speech in Schizophrenics and Depressives”, *Journal of Psychiatric Research*, Vol. 24, pp. 191 – 196, 1990.

- [98] B. Pope, T. Blass, A. W. Siegman, J. Rahe, "Anxiety and Depression in Speech", *Journal of Consulting and Clinical Psychology*, Vol. 35, pp. 128 – 133, 1970.
- [99] E. Szabadi, C. M. Bradshaw, J. A. O. Besson, "Elongation of Pause-Time in Speech: A Simple, Objective Measure of Motor Retardation in Depression", *The British Journal of Psychiatry*, Vol. 129, pp. 592 – 597, December 1976.
- [100] J. F. Greden, B. J. Carroll, "Decrease in Speech Pause Times with Treatment of Endogenous Depression", *Biological Psychiatry*, Vol. 15. Issue 4, pp. 575 – 587, August 1980.
- [101] J. K. Darby, N. Simmons, P. A. Berger, "Speech and Voice Parameters of Depression: A Pilot Study", *Journal of Communication Disorders*, Vol. 17, Issue 2, pp. 75 – 85, April 1984.
- [102] G. M. A. Hoffmann, J. C. Gonze, J. Mendlewicz, "Speech Pause Time as a Method for the Evaluation of Psychomotor Retardation in Depressive Illness", *The British Journal of Psychiatry*, Vol. 146, pp. 535 – 538, May 1985.
- [103] N. C. Andreasen, M. Alpert, M. J. Martz, "Acoustic Analysis", *Archives of General Psychiatry*, Vol. 38, pp. 281 – 285, 1981.
- [104] S. Kony, H. H. Stassen, "Speaking Behavior and Voice Sound Characteristics in Depressive Patients during Recovery", *Journal of Psychiatric Research*, Vol. 27, pp. 289 – 307, 1993.
- [105] H. H. Stassen, G. Bomben, E. Gunther, "Speech Characteristics in Depression", *Psychopathology*, Vol. 24, pp. 88 – 105, 1991.
- [106] P. Vanger, A. B. Summerfield, B. K. Rosen, J. P. Watson, "Effects of Communication Content on Speech Behavior of Depressives", *Comprehensive Psychiatry*, Vol. 33, pp. 39 – 41, 1992.
- [107] J. D. Teasdale, S. J. Fogarty, J. M. G. Williams, "Speech Rate as a Measure of Short – Term Variation in Depression", *British Journal of Social and Clinical Psychology*, Vol. 19, pp. 271 – 278, 1980.
- [108] J. F. Greden, A. A. Albala, I. A. Smokler, R. Gardner, B. J. Carroll, "Speech Pause

Time: A Marker of Psychomotor Retardation among Endogenous Depressives”, *Biological Psychiatry*, Vol. 16, Issue 9, pp. 851 – 859, September 1981.

- [109] H. P. D. Godfrey, R. G. Knight, “The Validity of Actometer and Speech Activity Measures in the Assessment of Depressed Patients”, *The British Journal of Psychiatry*, Vol. 145, pp. 159 – 163, August 1984.
- [110] P. Hardy, R. Jouvent, D. Widlocher, “Speech Pause Time and Retardation Rating Scale for Depression (ERD)”, *Journal of Affective Disorders*, Vol. 6, Issue 1, pp. 123 – 127, February 1984.
- [111] C. Ranelli, R. Miller, “Behavioral Predictors of Amitriptyline Response in Depression”, *The American Journal of Psychiatry*, Vol. 138, Issue 1, pp. 30 – 34, January 1981.
- [112] H. Ellgring, K. R. Scherer, “Vocal Indicators of Mood Change in Depression”, *Journal of Nonverbal Behavior*, Vol. 20, Issue 2, pp. 83 – 110, June 1996.
- [113] A. Ghozlan, D. Widlocher, “Ralentissement Psychomoteur Dépressif et Traitement de L’Information (Depressed Psychomotor Retardation and Information Processing)”, *Psychologie Française*, Vol. 33, pp. 251 – 258, 1988.
- [114] A. Bouhuys, W. Mulder-Hajonides Van Der Meulen, “Speech Timing Measures of Severity, Psychomotor Retardation, and Agitation in Endogenously Depressed Patients”, *Journal of Communication Disorders*, Vol. 17, Issue 4, pp. 277 – 288, 1984.
- [115] A. W. Siegman, “Expressive Correlates of Affective States and Traits”, *Nonverbal Behavior: A Multi-Channel Perspective*, pp. 37 – 68, In A. W. Siegman & S. Feldstein (Eds.), Hillsdale, NJ: Erlbaum, 1985.
- [116] K. Scherer, “Vocal Assessment of Affective Disorders”, *Depression and Expressive Behavior*, pp. 293 – 317, In J. D. Maser (Ed.), Hillsdale, NJ: Erlbaum, 1987.
- [117] A. W. Siegman, “Paraverbal Correlates Stress: Implications for Stress Identification and Stress Management”, *Handbook of Stress: Theoretical And Clinical Aspects*, In. L. Goldberger & S. Breznitz (Eds.), pp. 274 – 299, New

York: Free Press, 1993.

- [118] W. A. Hargreaves, J. A. Starkweather, K. H. Blacker, "Voice Quality in Depression", *Journal of Abnormal Psychology*, Vol.70, pp. 218 – 220, June 1965.

- [119] C. Sobin, M. Alpert, "Emotions in Speech: The Acoustic Attributes of Fear, Anger, Sadness, and Joy", *Journal of Psycholinguistic Research*, Vol. 28, Issue 4, pp. 347 – 365, July 1999.

- [120] M. Alpert, E. R. Pouget, R. R.Silva, "Reflections of Depression in Acoustic Measures of the Patient's Speech", *Journal of Affective Disorders*, Vol. 66, Issue 1, pp. 59 – 69, September 2001.

- [121] J. Darby, N. Simmons, unpublished pilot study, 1979.

- [122] P. Ostwald, "The Sounds of Emotional Disturbance", *Archives of General Psychiatry*, Vol. 5, pp. 587 – 592, 1961.

- [123] W. Hargreaves, J. Starkweather, K. H. Blacker, "Voice Quality Changes in Depression", *Language Speech*, Vol. 7, pp. 218 – 220, 1965.

- [124] P. F. Ostwald, *Soundmaking: The Acoustic Communication of Emotion*, Charles C. Thomas, Springfield: Illinois, 1963.

- [125] W. A. Hargreaves, J. A. Starkweather, "Voice Quality Changes in Depression", *Language and Speech*, Vol.7, pp.84 – 88, 1964.

- [126] D. J. France, "Acoustical Properties of Speech as Indicators of Depression and Suicidal Risk", Ph.D. Thesis, Vanderbilt University, Nashville, TN, August 1997.

- [127] A. Nilsonne, J. Sundberg, S. Ternstrom, A. Askenfelt, "Measuring the Rate of Change of Voice Fundamental Frequency in Fluent Speech during Mental Depression", *Journal of the Acoustical Society of America*, Vol. 83, Issue 2, pp. 716 – 728, February 1988.

- [128] E. N. Whitman, D. J. Flicker, "A Potential New Measurement of Emotional State: A Preliminary Report", *Newark Beth-Israel Hospital*, Vol. 17, pp. 167 – 172,

1966.

- [129] A. Nilsonne, "Speech Characteristics as Indicators of Depressive Illness", *Acta Psychiatrica Scandinavica*, Volume 77, Issue 3, pp. 253 – 263, March 1988.
- [130] A. Nilsonne, J. Sundberg, "Differences in Ability of Musicians and Nonmusicians to Judge Emotional State from the Fundamental Frequency of Voice Samples", *Music Perception*, Vol. 2, Issue 4, pp. 507 – 516, 1985.
- [131] A. Askenfelt, A. Sjolín- Nilsonne, "Voice Analysis in Depressed Patients: Rate of Change of Fundamental Frequency Related to Mental State", *STL-QPSR*, Vol.2, Number 3, pp.71 – 84, 1980.
- [132] R. Roessler, J. Lester, "Voice Predicts Affect during Psychotherapy", *Journal of Nervous and Mental Disease*, Vol. 3, pp. 166 – 176, 1976.
- [133] W. A. Hargreaves, J. A. Starkweather, "Vocal and Verbal Indicators of Depression", Unpublished Manuscript, University of California Medical School, San Francisco, 1965.
- [134] G. Fleischmann, "Akustisch-Phonetische Untersuchungen an der Sprache der Depression (Acoustic-Phonetic Studies of Speech of Depressives)", Unpublished Master's Thesis, University of Cologne, 1980.
- [135] S. Heitman, "Sprechstimmveränderungen bei Psychotikern (Voice Changes in Psychotic Patients)", Unpublished Diploma Thesis, University of Giessen, 1980.
- [136] A. Ozdas, R. G. Shiavi, S. E. Silverman, M. K. Silverman, D. M. Wilkes, "Investigation of Vocal Jitter and Glottal Flow Spectrum as Possible Cues for Depression and Near-Term Suicidal Risk", *IEEE Transactions on Biomedical Engineering*, Vol. 51, Issue 9, September 2004.
- [137] E. Moore II, M. Clements, J. Peifer, L. Weisser, "Analysis of Prosodic Variation in Speech for Clinical Depression", *Proceedings of the 25th Annual International Conference of the Engineering in Medicine and Biology Society*, Vol. 3, pp. 2925 – 2928, September 2003.
- [138] E. Moore II, M. Clements, J. Peifer, L. Weisser, "Investigating the Role of Glottal

Features in Classifying Clinical Depression”, Proceedings of the 25th Annual International Conference of the Engineering in Medicine and Biology Society, Vol. 3, pp. 2849 – 2852, September 2003.

- [139] E. Moore II, M. Clements, J. Peifer, L. Weisser, “Comparing Objective Feature Statistics of Speech for Classifying Clinical Depression”, Proceedings of the 26th Annual International Conference of the Engineering in Medicine and Biology Society, Vol. 1, pp. 17 – 20, September 2004.
- [140] E. Moore II, M. Clements, J. Peifer, L. Weisser, “Critical Analysis of the Impact of Glottal Features in the Classification of Clinical Depression in Speech”, IEEE Transactions on Biomedical Engineering, Vol. 55, Issue 1, pp. 96 – 107, January 2008.
- [141] I. B. Goldstein, “The Relationship of Muscle Tension and Automatic Activity to Psychiatric Disorders”, Psychosomatic Medicine, Vol. 27, pp. 39 – 52, 1965.
- [142] K. R. Scherer, “Personality Markers in Speech”, In K. R. Scherer & H. Giles (Eds.), Social Markers in Speech, pp. 147 – 209, Cambridge University Press, Cambridge, UK, 1979.
- [143] J. F. Greden, H. L. Price, N. Genero, M. Feinberg, S. Levine, “Facial EMG Activity Levels Predict Treatment Outcome in Depression”, Psychiatry Research, Vol. 13, pp. 345 – 352, 1984.
- [144] K. R. Scherer, “Vocal Correlates of Emotional Arousal and Affective Disturbance”, In H. Wagner and A. Manstead (Eds.), Handbook of Social Psychophysiology, pp. 165 – 197, Wiley, New York, 1989.
- [145] H. G. Wallbott, “Vocal Behavior and Psychopathology”, Pharmacopsychiatry, Vol. 22, Issue 1, pp. 13 – 16, February 1989.
- [146] G. Fant, The Acoustic Theory of Speech Production, The Hague, Netherlands, 1960.
- [147] A. Flint, S. Black, I. Campbell-Taylor, G. Gailey, C. Levington, “Acoustic Analysis in the Differentiation of Parkinson’s Disease and Major Depression”, Journal of Psycholinguistic Research, Vol. 21, Issue 5, pp. 383 – 399, September

1992.

- [148] K. R. Scherer, “Vocal Affect Expression: A Review and a Model for Future Research”, *Psychological Bulletin*, Vol. 99, Issue 2, pp. 143 – 165, March 1986.
- [149] H. H. Stassen, “Affective State and Voice: The Specific Properties of Overtone Distributions”, *Methods of Information in Medicine*, Vol. 30, Issue 1, pp. 44 – 52, 1991.
- [150] D. J. France, R. G. Shiavi, S. Silverman, M. Silverman, D. M. Wilkes, “Acoustical Properties of Speech as Indicators of Depression and Suicidal Risk”, *IEEE Transactions on Biomedical Engineering*, Vol. 47, Issue 7, pp. 829 – 837, July 2000.
- [151] S. E. Silverman, “Vocal Parameters as Predictors of Near-Term Suicidal Risk”, U.S. Patent 5 148 483, September 1992.
- [152] L. Campbell, “Statistical Characteristics of Fundamental Frequency Distributions in the Speech of Suicidal Patients”, Master’s Thesis, Vanderbilt University, Nashville, TN, 1995.
- [153] A. Ozdas, R. G. Shiavi, S. E. Silverman, M. K. Silverman, D.M. Wilkes, “Analysis of Fundamental Frequency for Near Term Suicidal Risk Assessment”, *IEEE International Conference on Systems, Man, and Cybernetics*, pp.1853 – 1858, 2000.
- [154] A. Ozdas, R. G. Shiavi, D. M. Wilkes, M. K. Silverman, S. E. Silverman, “Analysis of Vocal Tract Characteristics for Near-Term Suicidal Risk Assessment”, *Methods of Information in Medicine*, Vol. 43, Issue 1, pp. 36 – 38, 2004.
- [155] A. Ozdas, “Analysis of Paralinguistic Properties of Speech for Near-Term Suicidal Risk Assessment”, Ph.D. Thesis, Vanderbilt University, Nashville, TN, 2001.
- [156] Y. Horii, “Fundamental Frequency Perturbation Observed in Sustained Phonation”, *Journal of Speech and Hearing Research*, Vol. 22, Issue 1, pp. 5 –19 March 1979.
- [157] H. Hollien, J. Michel, E. T. Doherty, “A Method for Analyzing Vocal Jitter in a

Sustained Phonation”, *Journal of Phonetics*, Vol.1, Issue 1, pp. 85 – 91, January 1973.

- [158] T. Yingthawornsuk, H. Kaymaz Keskinpala, D. J. France, D. M. Wilkes, R.G. Shiavi, R. M. Salomon, “Objective Estimation of Suicidal Risk Using Vocal Output Characteristics”, Ninth International Conference on Spoken Language Processing (Interspeech 2006 - ICSLP), pp. 649 – 652, 2006.
- [159] T. Yingthawornsuk, H. Kaymaz Keskinpala, D. M. Wilkes, R.G. Shiavi, R. M. Salomon, “Direct Acoustic Feature Using Iterative EM Algorithm and Spectral Energy for Classifying Suicidal Speech”, Eighth Annual Conference of the International Speech Communication Association (Interspeech 2007), pp. 766 – 769, 2007.
- [160] T. Yingthawornsuk, “Acoustic Analysis of Vocal Output Characteristics for Suicidal Risk Assessment”, Ph.D Thesis, Vanderbilt University, Nashville, TN 2007.
- [161] Fairbanks, G., *Voice and Articulation Drillbook*, Harper & Row, New York, 1960.
- [162] M. Hamilton, “A Rating Scale for Depression”, *Journal of Neurology, Neurosurgery and Psychiatry*, Vol. 23, pp. 56 – 62, February 1960.
- [163] F. Zheng, G. Zhang, Z. Song, “Comparison of Different Implementations of MFCC”, *Journal of Computer Science & Technology*, Vol. 16, Issue 6, pp. 582 – 589, September 2001.
- [164] D. O’Shaughnessy, *Communication: Human and Machine*, Addison-Wesley, Massachusetts, 1987.
- [165] E. Eide, H. Gish, “A Parametric Approach to Vocal Tract Length Normalization”, *ICASSP Proceedings*, pp. 346 – 348, 1996.
- [166] H.M. Gonzales, W.A. Vega, D.R. Williams, W. Tarraf, B.T. West, H. W. Neighbors, “Depression Care in the United States: Too Little for Too Few”, *Archives of General Psychiatry*, 67(1), pp. 37-46, 2010.
- [167] American Psychiatric Association (APA) Practice Guideline for Treatment of

Patients with Major Depressive Disorder (3rd Edition), available at <http://www.psych.org/guidelines/mdd2010> , October 2010.

- [168] J. Pagura, S. Fotti, L.Y. Katz, J. Sareen, “Help Seeking and Perceived Need for Mental Health Care among Individuals in Canada with Suicidal Behaviors”, *Psychiatr Serv.*, 60(7), pp. 943-949, July 2009.
- [169] G. E Peterson, H.L. Barney, “Control Methods Used in a Study of the Vowels”, *Journal of the Acoustical Society of America*, Vol.24, pp. 175-184, 1952.
- [170] T. Chiba, M. Kajiyama, *The Vowel-Its Nature and Structure*, Kaiseikan, Tokyo1941.
- [171] J. J. Ohala, “Cross-Language Use of Pitch: An Ethnological View”*Phonetica*, pp. 1-18, 1983.
- [172] H. Kaymaz Keskinpala, “Depression, Suicide Risk and Their Effect on Speech”, Major Area Paper and Research Proposal, Graduate School of Vanderbilt University, July 2009.
- [173] G. Fant, “Vocal Tract Energy Functions and Non-Uniform Scaling”, *Journal of the Acoustical Society of Japan*, Vol.11, pp. 1 – 18, 1976.
- [174] M. Hirano, J. Kurita, and T. Nakahima, “Growth, Development, and Aging of Human Vocal Folds”, *Vocal Fold Physiology: Contemporary Research and Clinical Issues*, edited by D. Bless and J. Abbs, College-Hill Press, San Diego, CA, pp.22 – 43, 1983.
- [175] I. R. Titze, “Physiology of the Female Larynx”, *Journal of the Acoustical Society of America Suppl.*, Vol.82, Issue S1, pp. S90, 1987.
- [176] I.R. Titze, “Physiologic and Acoustical Differences between Male and Female Voices”, *Journal of the Acoustical Society of America*, Vol.85, Issue 4, pp. 1699 – 1707, April 1989.
- [177] H. A. Leeper, A. P. Rochet, I. R. A. MacKay, “Characteristics of Nasalance in Canadian Speakers of English and French”, *Proceedings of International Conference on Spoken Language Processing*, pp. 49 – 52, 1992.

- [178] E. J. Seaver, R. M. Dalston, H. A. Leeper, L. E. Adams, "A Study of Nasometric Values for Normal Nasal Resonance", *Journal of Speech and Hearing Research*, Vol. 34, pp. 715 – 721, August 1991.
- [179] G. Fant, *The Acoustic Theory of Speech Production*, The Hague, Netherlands, 1960.
- [180] T. E. Carlson, "Some Acoustical and Perceptual Correlates of Speaker Gender Identification", Ph.D. Dissertation Proposal, University of Florida, Gainesville, 1981.
- [181] H. Hollien, E. Malcik, "Evaluation of Cross – Sectional Studies of Adolescent Voice Changes in Males", *Speech Monogr.*, Vol.34, pp.80 – 84, 1967.
- [182] J. Saxman, K. Burk, "Speaking Fundamental Frequency Characteristics of Middle – Aged Females", *Folia Phoniatr*, Vol.19, Issue 3, pp. 167 – 172, 1967.
- [183] H. Hollien, P. Paul, "A Second Evaluation of the Speaking Fundamental Frequency Characteristics of Post – Adolescent Girls", *Language Speech*, Vol.12, Issue 2, pp.119 – 124, April – June 1969.
- [184] H. Hollien, B. Jackson, "Normative Data on the Speaking Fundamental Frequency Characteristics of Young Adult Males", *Journal of Phonetics*, Vol. 1, pp.117 – 120, 1973.
- [185] R. B. Mosen, A. M. Engebretson, "Study of Variations in the Male and Female Glottal Wave", *Journal of the Acoustical Society of America*, Vol.62, Issue 4, pp. 981 – 993, October 1977.
- [186] M. Stoicheff, "Speaking Fundamental Frequency Characteristics of Non – Smoking Female Adults", *Journal of Speech and Hearing Research*, Vol. 24, pp. 437 – 441, September 1981.
- [187] Y. Horri, W. J. Ryan, "Fundamental Frequency Characteristics and Perceived Age of Adult Male Speakers", *Folia Phoniatr*, Vol. 33, Issue 4, pp. 227 – 233, 1981.
- [188] S. E. Linville, H. B. Fisher, "Acoustic Characteristics of Perceived Versus Actual Vocal Age in Controlled Phonation by Adult Females", *Journal of the Acoustical*

Society of America, Vol.78, Issue 1, pp. 40 – 48, July 1985.

- [189] C.G. Henton, “Fact and Fiction in the Description of Female and Male Pitch”, *Journal of the Acoustical Society of America Suppl.*, Vol.82, Issue S1, pp. S91, 1987.
- [190] I. Karlson, “Evaluations of Acoustic Differences between Male and Female Voices: A Pilot Study”, *Speech Trans. Lab., Quarterly Progress and Status Report, Number 1*, Vol.33, pp. 19 – 31, Royal Institute of Technology, Stockholm, 1992.
- [191] D. Childers, K. Wu, “Gender Recognition from Speech. Part II: Fine Analysis”, *Journal of the Acoustical Society of America*, Vol.90, Issue 4, pp. 1841 – 1856, October 1991.
- [192] K. Wu, D.G. Childers, “Gender Recognition from Speech. Part II: Coarse Analysis”, *Journal of the Acoustical Society of America*, Vol.90, Issue 4, pp. 1828 – 1840, October 1991.
- [193] H. M. Hanson, E. S. Chuang, “Glottal Characteristics of Male Speakers: Acoustic Correlates and Comparison with Female Data”, *Journal of the Acoustical Society of America*, Vol. 106, Issue 2, pp. 1064 – 1077, 1999.
- [194] D. H. Klatt, L. C. Klatt, “Analysis, Synthesis and Perception of Voice Quality Variations among Female and Male Talkers”, *Journal of the Acoustical Society of America*, Vol.87, Issue 2, pp. 820 – 857, February 1990.
- [195] Y. Horii, “Jitter and Shimmer Differences among Sustained Vowel Phonations”, *Journal of Speech and Hearing Research*, Vol.25, pp.12 – 14, 1982.
- [196] K. Wilcox, Y. Horii, “Age and Changes in Vocal Jitter”, *Journal of Gerontology*, Vol.35, Issue 2, pp.194 – 108, March 1980.
- [197] C. Ludlow, C. Bassich, N. Connor, D. Coulter, Y. Lee, “The Validity of Using Phonatory Jitter and Shimmer to Detect Laryngeal Pathology”, *Laryngeal Function in Phonation and Respiration*, pp. 492 – 508, Boston: Little & Brown, 1987.
- [198] P. Milenkovic, “Least Mean Square Measures of Voice Perturbation”, *Journal of*

Speech and Hearing Research, Vol.30, Issue 4, pp. 529 – 538, December 1987.

- [199] L. Kaiser, “Biological and Statistical Research Concerning the Speech of 216 Dutch Students”, *Arch. Neerlandaises de Phonetique Experimentale* 15, pp. 1 – 76 and 16, pp. 77 – 136, 1940.
- [200] C. C. Elert, *Phonological Studies of Quantity in Swedish*, Almqvist & Wiksell, Uppsala, 1964.
- [201] D. Kuehn, K. Moll, “A Cineradiographic Study of VC and CV Articulatory Velocities”, *Journal of Phonetics*, Vol.4, pp. 303 – 320, 1976.
- [202] J. Sachs, P. Lieberman, D. Erickson, “Anatomical and Cultural Determinants of Male and Female Speech”, *Language Attitudes*, Washington DC, Georgetown University Press, pp. 74 – 83, 1973.
- [203] D. Byrd, “Relations of Sex and Dialect to Reduction”, *Speech Communication*, Vol. 15, pp. 39 – 54, 1994.
- [204] B. L. Swartz, “Gender Differences in Voice Onset Time”, *Perceptual Motor Skills*, Vol.75, pp. 983 – 992, 1992.
- [205] S. P. Whiteside, “Temporal-based Acoustic-Phonetic Patterns in Read Speech: Some Evidence for Speaker Sex Differences”, *Journal of the International Phonetic Association*, Vol. 26, Issue 1, pp. 23 – 40, 1996.
- [206] S. Singh, T. Murry, “Multidimensional Classification of Normal Voice Qualities”, *Journal of the Acoustical Society of America Suppl.*, Vol.64, Issue 1, pp. S81 – S87, July 1978.
- [207] T. Murry, S. Singh, “Multidimensional Analysis of Male and Female Voices”, *Journal of the Acoustical Society of America*, Vol.68, Issue 5, pp. 1294 – 1300, November 1980.
- [208] D. H. Klatt, “Acoustic Correlates of Breathiness: First Harmonic Amplitude,

Turbulence Noise, and Tracheal Coupling”, Journal of the Acoustical Society of America, Vol.82, Issue S1, pp. S91, November 1987.

- [209] H. M. Hanson, “Glottal Characteristics of Female Speakers: Acoustic Correlates”, Journal of the Acoustical Society of America, Vol. 101, Issue 1, pp. 466 – 481, 1997.
- [210] A. M. Sulter, H. P. Wit, “Glottal Volume Waveform Characteristics in Subjects With and Without Vocal Training, Related Gender, Sound Intensity, Fundamental Frequency, and Age”, Journal of the Acoustical Society of America, Vol.100, Issue 5, pp. 3360 – 3373, November 1996.
- [211] H. Kaymaz Keskinpala, T. Yingthawornsuk, D. M. Wilkes, R.G. Shiavi, R. M. Salomon, “Screening for High Risk Suicidal States Using Mel- Cepstral Coefficients and Energy in Frequency Bands”, Fifteenth European Signal Processing Conference (EUSIPCO), pp. 2229 – 2233, September 2007.
- [212] H. Kaymaz Keskinpala, T. Yingthawornsuk, D. M. Wilkes, R.G. Shiavi, R. M. Salomon, " Distinguishing High Risk Suicidal Subjects among Depressed Subjects Using Mel-Frequency Cepstrum Coefficients and Cross Validation Technique", 5th International Workshop on Models and Analysis of Vocal Emissions for Biomedical Applications (MAVEBA 2007),pp. 157 – 160, December 2007.